

# **Proweld™ Equipment** **Operations & Maintenance** **Manual**

## **4” Socket Bench Welding Tool**



Tel: 781-321-5409 • Fax: 800-787-6861 • Toll Free: 800-343-3618  
[www.asahi-america.com](http://www.asahi-america.com) • [asahi@asahi-america.com](mailto:asahi@asahi-america.com)  
Direct Sales: East 800-232-7244 / Central 800-442-7244 / West: 800-282-7244

# TABLE OF CONTENTS

<b>Section</b>	<b>Page</b>
<b>I. Safety Precautions</b>	<b>3</b>
<b>II. Machine Setup and Operation</b>	<b>4</b>
<b>III. Welding Parameters</b>	<b>8</b>
<b>IV. Welding Process</b>	<b>11</b>
<b>V. Maintenance</b>	<b>14</b>
<b>VI. Asahi/America Contacts</b>	<b>15</b>

## Section I – Safety Precautions

1. Keep working area clean and tidy.
2. Keep electrical tools away from moisture. Never use in a wet environment or humid conditions. Working area should be well illuminated. Keep tools away from chemicals and other corrosive materials.
3. Keep visitors at a safe distance.
4. Ensure the electrical supply is suitable for the machine.
5. The heating element reaches 500° F (260° C). Do not touch the surface of the heating element and wear safety gloves.
6. Never carry tools by the electric cable. Never unplug by pulling the cable. Keep cables away from oil, heat, and sharp edges.
7. Prior to use, check that no components are damaged. Missing or worn out parts should be replaced immediately. Only use factory parts.
8. Electrical tools not in use should be stored away safely.

## SECTION II – Machine Set Up and Operation

### 1. General Tool Parameters

Pipe/Fitting Material:	PE, PP, PVDF
Size Range:	½" - 4½" (20mm – 125mm)
Transport Box Size (L X W X H):	34" x 27" x 27"
Weight:	177 lbs.
Breaker:	16 Amps
Voltage Requirement:	110V (+/- 10%)

### 2. Description of Tool Elements

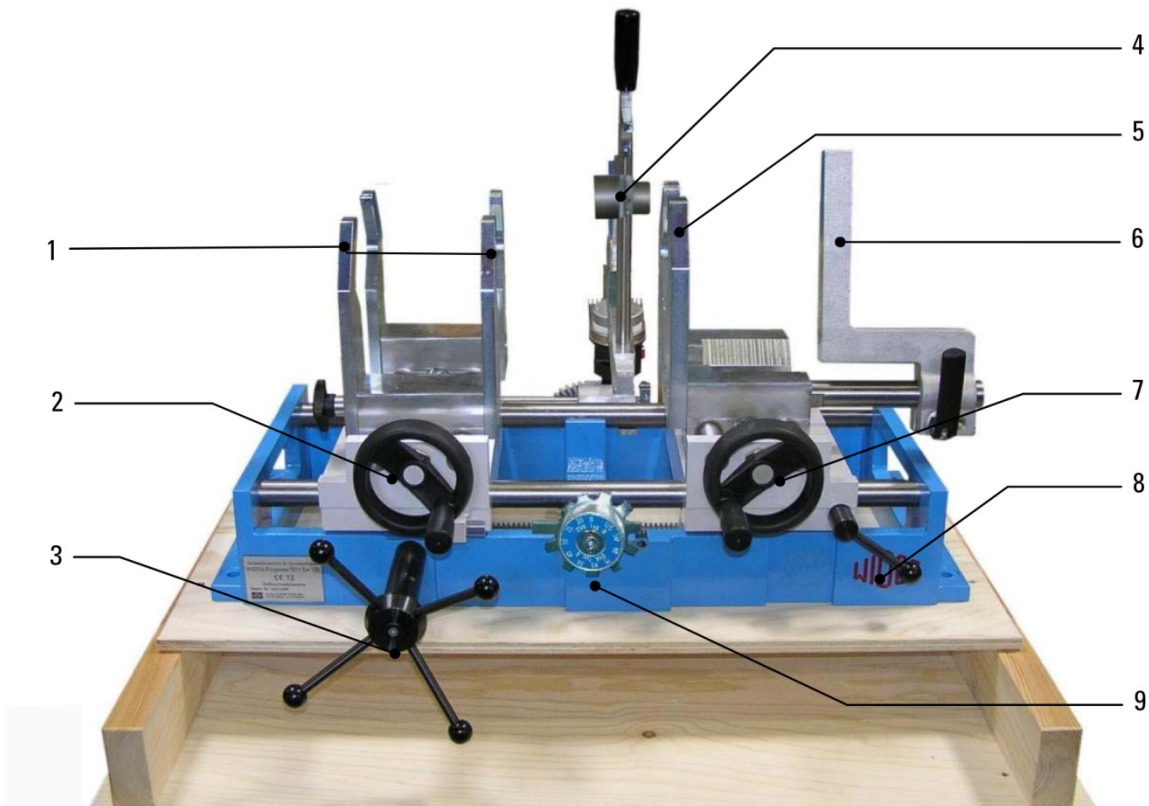

No.	Description
1	Clamping tool left for pipe
2	Handle for pipe clamping tool left side, clamping tool open/close
3	Cross handle for slides; both slides open/close
4	Heating element with spigot and socket
5	Clamping tool for fitting right side

6	Universal support for fittings
7	Handle for fitting clamping tool tight side, clamping tool open/close
8	Clamping lever for locking slides
9	Dial (DVS Type B / DVS Type A / ASTM IPS inch) for insertion depth and zero setup

### 3. Parts of the Heating Element

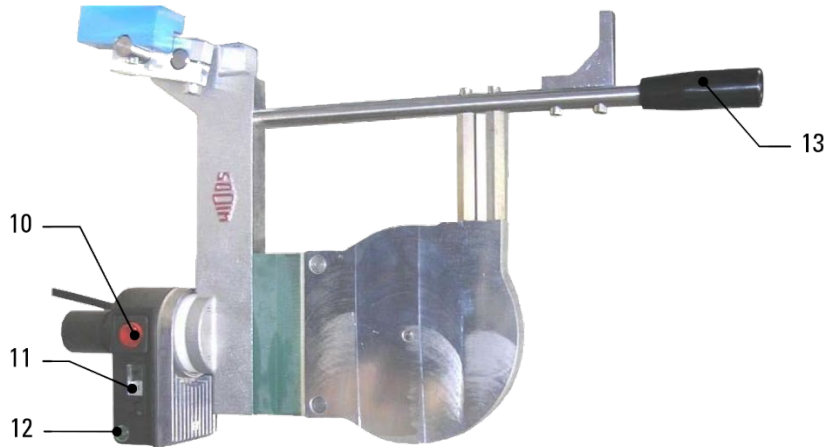

No.	Description	Function
10	Switch on/off	Red light as soon as the heating element is switched on
11	Knob with slot	Setting the heating element temperature
12	Control lamp green	Three different states: <u>Off</u> : Signal showing that the heating element is not heated up at the moment or that it is cooling. <u>Blinking</u> : The temperature of the heating element is maintained by a defined pulse-position ratio. <u>On</u> : Signal showing that the heating element is heated up at the moment. The nominal temperature has not been reached yet.
13	Grip	Swiveling the heating element in/out manually

#### 4. Accessories



No.	Description
14	Pipe chamfer tool for 15°- chamfering the pipe end (optional)
15	Socket
16	Spigot

#### 5. Clamping Tool for Pipe

There are two sizes of the pipe clamping tool; 1/2" - 1-1/2" (OD 20mm - OD 50mm) and 1-1/2" - 4-1/2" (OD 50mm - OD 125mm). The clamping claws of the pipe clamping tool sit on straight pins internally and externally. The internal claws are mounted by flat-head screws and the external with star handle.

Clamping jaw inside:

Clamping jaw outside:



Marking of size  
Straight pin  
Flat-head screw

Star handle

## 6. How to change internal clamping claws

A. Remove the flat-head screws and detach the clamping jaws. Set the clamping jaw with other size on the straight pins and mount it with flat-head screw.

## 7. How to change external clamping claws

A. Loosen the star screws, detach the clamping claw from straight pins and remove it from the top. Set the clamping jaw with the other size on the straight pins and mount it with the star handle.

## 8. Clamping Tool for Fitting

The clamping jaws of the fitting clamping tool sit on straight pins and are mounted with flat-head screws.

- A. To change a jaw, remove the flat-head screw and detach the jaw.
- B. Set the clamping jaw with other size on the straight pins and mount it with flat-head screw.

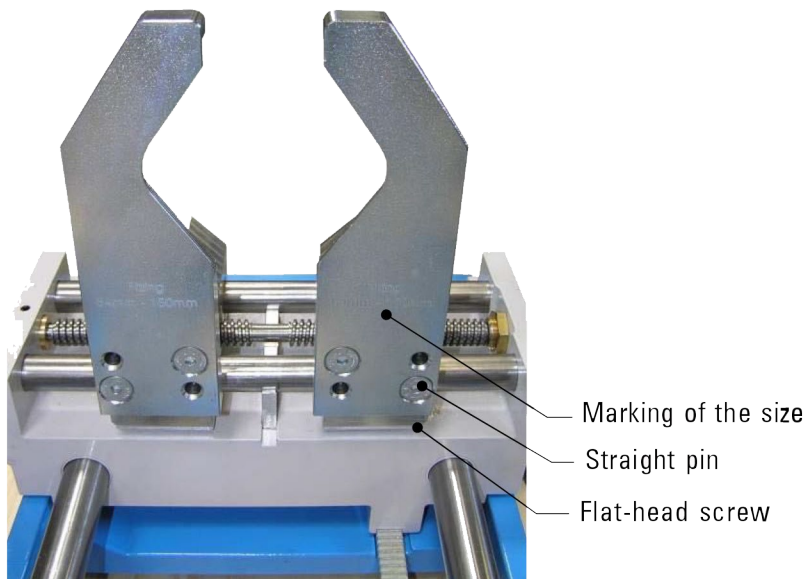

## 9. Fitting Support

With the support, you can support fittings. For long fittings, the support can be rotated as depicted below, on the right. The clamping level is used to fix the position of the fitting support.

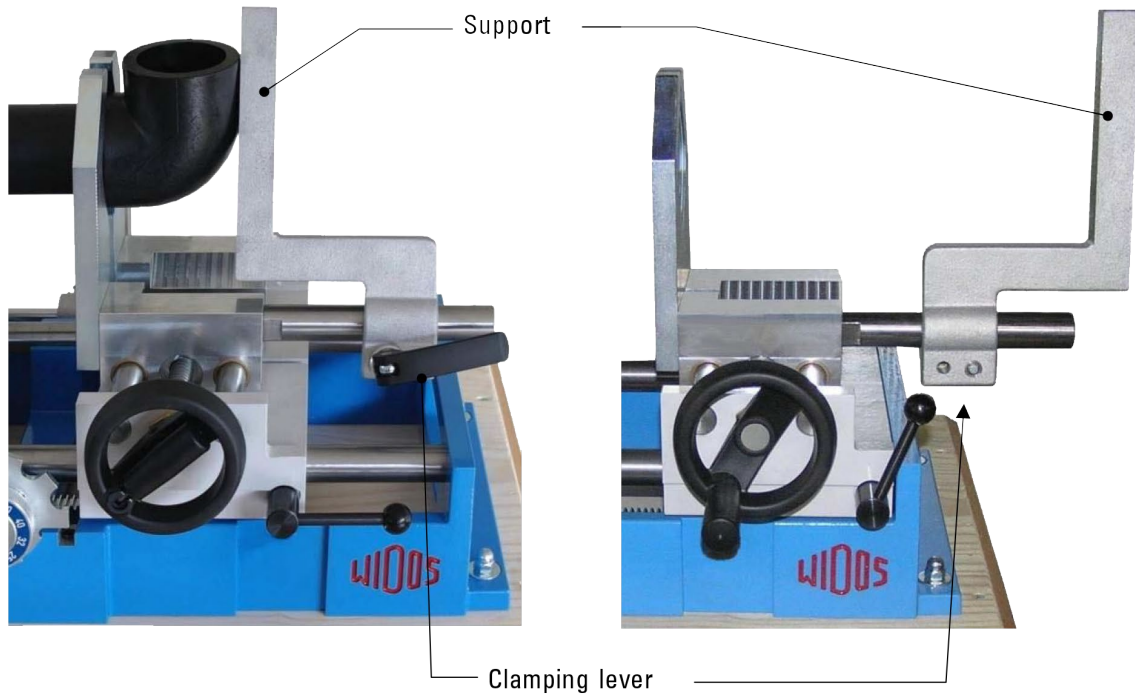

### Section III – Welding Parameters

Weld parameters are located on a separate document. All rented or purchased tools will include a physical copy of the latest weld parameters.

Parameters can also be accessed in the following ways:

- A. Located on our website at [www.asahi-america.com](http://www.asahi-america.com) under the resources tab of each product page.
- B. Through Asahi/America’s welding web app at <https://myasahi.asahi-america.com/welding> or scan the QR code on the right.



#### How to scan the QR code:

1. Most phones now have the native capability to scan QR codes using the camera on the phone, with no additional QR app required. If you’re having trouble with this, there are multiple free QR reader apps available wherever you download your apps.
2. Open up the camera app on your phone or tablet.



3. Hover the camera over the QR code (without taking a photo); focus the camera if needed.



4. Wait for a web address pop-up to appear. Click on the pop-up to take you the weld parameter app.

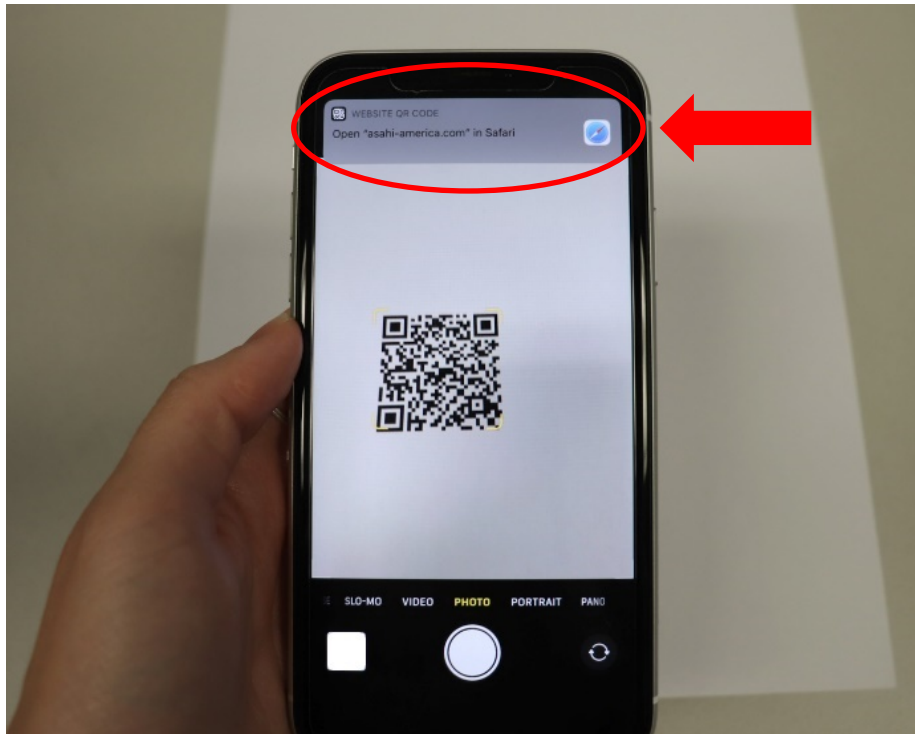

How to use the weld web app:

1. To search for a parameter, fill out all four fields: tool, piping system, product line & material, and pipe size from the drop-down options. Then, click 'search'.

2. The appropriate parameters will appear. Click the 'start' and 'reset' buttons to use the timer. To search for a different parameter, click 'search' in the upper left corner.

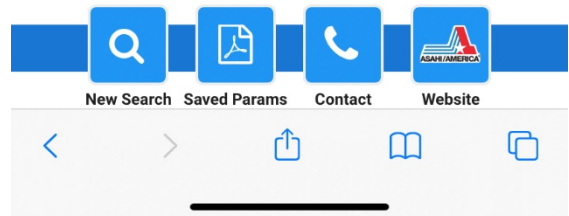
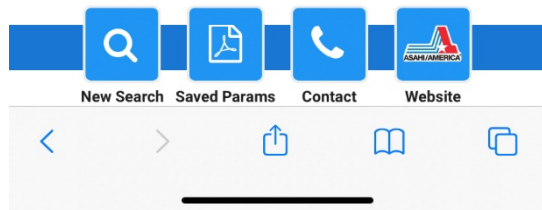
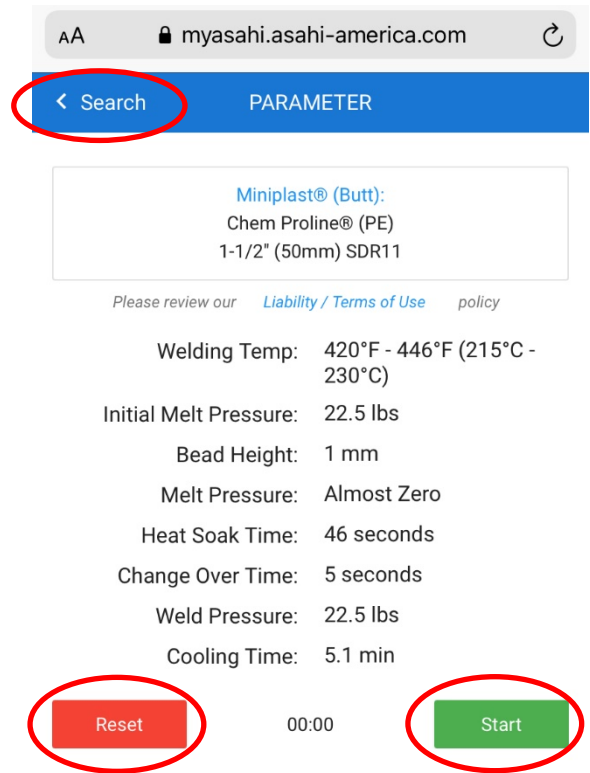
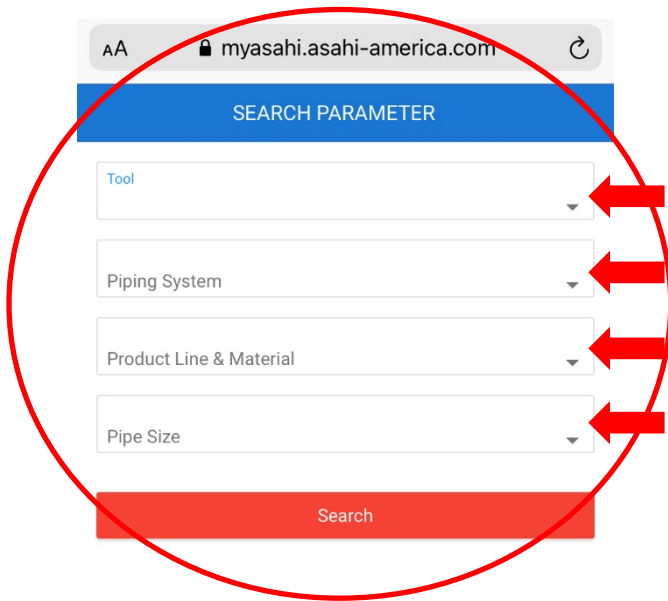

## Section IV – Welding Process

### 1. Preparation

- A. Safety gloves should be worn to protect from potential burns from the heating element.
- B. A stop watch or timer should be available for timing during the welding process (heating time, cooling time, etc.)
- C. Welding parameters, either printed or available through the Asahi/America's welding app at <https://myasahi.asahi-america.com/welding>, should be available to guide the welding process.

### 2. Tool and Workpiece Setup

- A. Clean the heater bushings with lint-free paper/cloth and isopropyl alcohol and install them on the heating element. The spigot bushing should be on the right-hand side, and the socket on the left-hand side.
- B. In addition, the workpieces (fitting and pipe) must be clean before welding. If need be, clean them with isopropyl alcohol and lint-free paper.
- C. The ends of the pipe must be beveled, either with a PREP tool or a pipe beveller.
  - Polyolefins (PP/PE) must be scraped as well, using either the PREP tool or a scraping tool.
- D. Mount the clamps with the matching diameter to the pipe on the left side.

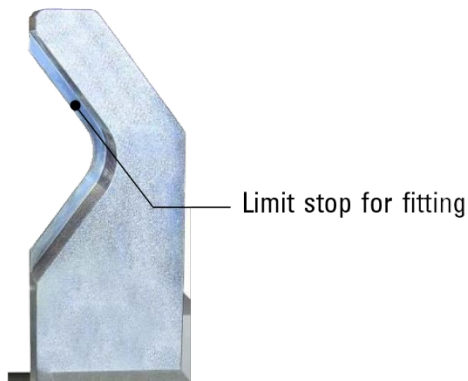

- E. Mount the clamps with the matching diameter to the fitting on the right side.
- F. The anti-stick coating of the heating element must remain undamaged in the working area.
- G. Switch on the heating element and, if necessary, adjust the welding temperature at the set screw at the handle. If the control light blinks, the nominal temperature has been reached.
- H. Insert the fitting in the right-hand clamping tool onto the limit stop.

- I. Clamp the fitting by handle.

- J. Support the fitting with support if necessary
- K. Turn the dial until the position "0" locks over the red spot.

Shown: dials for metric pipe (DVS A and DVS B)



- L. Close the machine until the dial rests against the stop bolt (above) and fix this position with the clamping lever (8).
- M. Insert the chamfered pipe so that the end face is adjacent to the fitting.
- N. Close the pipe clamps and clamp the pipe by the handle.

### 3. Positioning of different pipes towards the fitting:

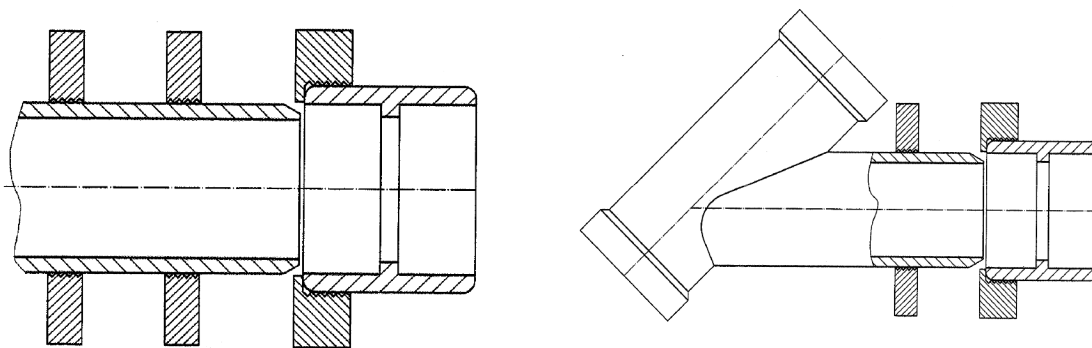

- A. Release the clamping lever and open the tool.
- B. Turn the dial until the desired pipe size is above the red spot.

#### 4. Fusion Process

- A. After the heating element has been brought to temperature, move the heating element into the machine. The heating element must be locked into the recess on the frame in front.
- B. Close the tool, driving the workpieces with smooth, steady force into the heating elements until both the spigot and socket are completely inserted. Secure the closed position with the clamping lever and begin timing the heat-up time.
- C. Both work pieces should touch the heating socket at the same time.

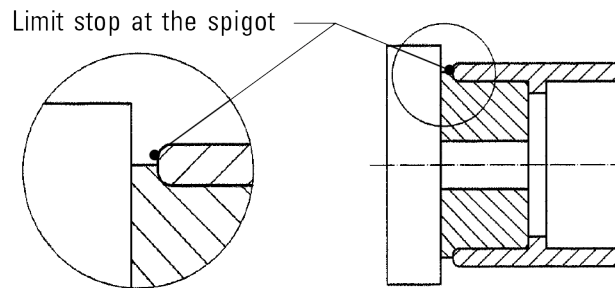

- D. When the heating time has passed, release the clamping lever, open the machine quickly, remove the heating element and drive the slides together immediately with a smooth, steady force until the dial rests against the stop bolt. The amount of time between removing the workpieces from the heating elements and closing the tool must not exceed the changeover time.
- E. Secure the closed position with the clamping lever and begin timing for the cooldown time.
- F. After the cooling time has passed, release the clamping lever, open the clamping tools and remove the welded part.
- G. The welding process is completed.

## **Section V - Maintenance / Storage / Transport**

### **1. Maintenance**

- A. Replace defective parts immediately, be especially careful with electric parts – dirt and moisture should be removed regularly.
- B. Use original tool spare parts only.
- C. According to DVS, preventative maintenance and factory inspection are recommended yearly with normal use.
- D. Tools used frequently should have the maintenance program completed earlier than the one-year standard.
- E. The maintenance should be performed by trained factory technicians.

### **2. Storage**

- A. Keep the guide rods, toothed rods, toothed wheel and trapezoid spindle free from dirt and covered with a thin oil film.
- B. Cover the machine during non-use.
- C. The tool should be cleaned and completely dry prior to storage to prevent corrosion.

### **3. Transport**

- A. The machine is transported in a transport box.
- B. Take care that the cable of the heating element is not pinched during storage
- C. Handle the machine carefully and protect from excessive vibration and impact shocks
- D. Make sure that the box cover is correctly locked.

### **4. Alignment**

- A. Alignment is only normally required after major parts replacement. This alignment should only be completed by factory trained technicians.

# TOOL DEPARTMENT CONTACTS

## **Equipment Rental**

### **Rental Equipment Manager**

781-388-4618

[toolmanager@asahi-america.com](mailto:toolmanager@asahi-america.com)

### **Rental Administration, Billing & Returns**

781-388-4623

[toolrental@asahi-america.com](mailto:toolrental@asahi-america.com)

## **Field Technician/Onsite Training**

### **Field Training**

617-480-7071

[info@asahi-america.com](mailto:info@asahi-america.com)

## **Technical Service**

### **High Purity, Double Wall or Industrial Piping**

781-321-5409

[pipe@asahi-america.com](mailto:pipe@asahi-america.com)

## **Asahi/America Corporate Headquarters**

### **Asahi/America, Inc.**

655 Andover St.

Lawrence, MA 01843

800-343-3618

[asahi@asahi-america.com](mailto:asahi@asahi-america.com)

# Another Corrosion Problem Solved.<sup>TM</sup>



Tel: 781-321-5409 • Fax: 800-787-6861 • Toll Free: 800-343-3618  
[www.asahi-america.com](http://www.asahi-america.com) • [asahi@asahi-america.com](mailto:asahi@asahi-america.com)  
Direct Sales: East 800-232-7244 / Central 800-442-7244 / West: 800-282-7244