

Engineering Design Guide

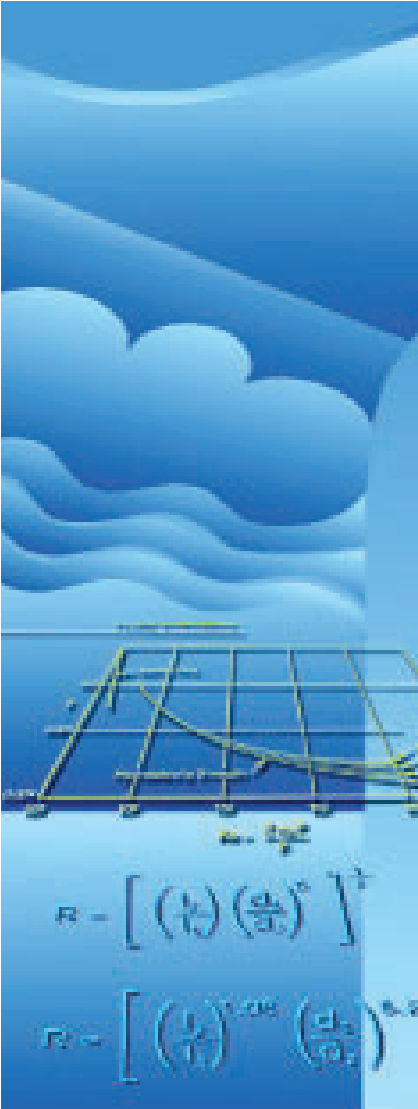

Single Wall Piping • Double Wall Piping • Gas & Air Handling Systems
• Materials • System Design • Installation

**Another
Corrosion
Problem
Solved.™**



CHOOSE ASAHI/AMERICA

**AN IMMENSE RESOURCE FOR TECHNICAL
AND DESIGN INFORMATION**

**AN ENGINEERING STAFF TO ASSIST IN
DESIGN REVIEWS**

**THE WIDEST SELECTION OF THERMO-
PLASTIC PIPING PRODUCTS ON THE
MARKET.**

**INSTALLATION EQUIPMENT AND FIELD
SERVICE TRAINING EMPLOYING THE
LATEST JOINING TECHNOLOGIES**

**CUSTOM FABRICATION AND ASSEMBLY
OF SYSTEMS AT OUR FACILITY**

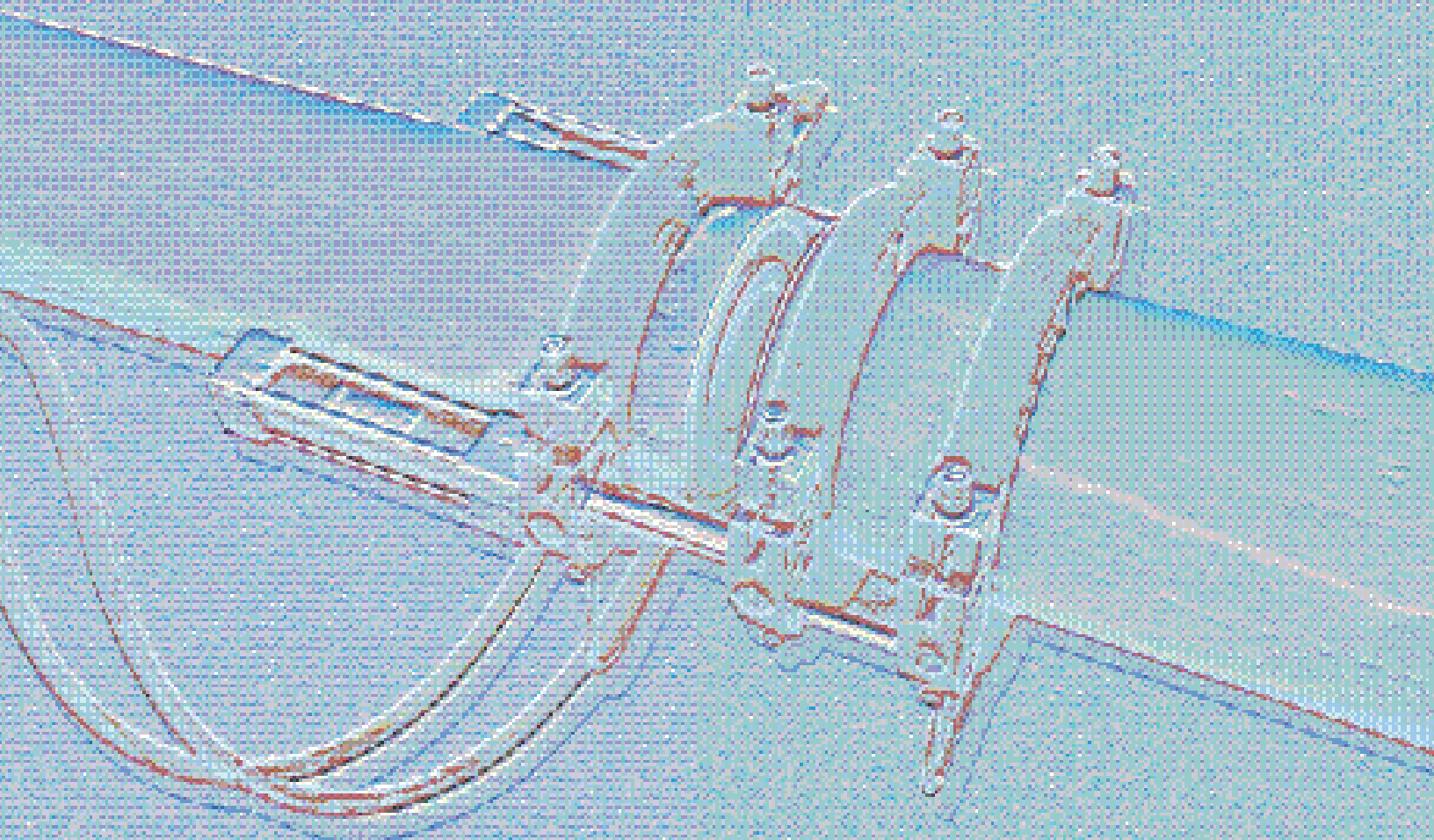

ENGINEERING DESIGN GUIDE

ASAHI/AMERICA, INC.
Lawrence, Massachusetts

Disclaimer

Asahi/America, Inc. provides this guide to assist engineers in the design of systems, installers in the installation and owners in the operation. This guide is designed to provide the best possible recommendations known at the time of printing. Each and every type of piping system is different and no one recommendation can cover all conditions. This guide is made available to assist in the design and installation, but in no way should be construed as a written recommendation on any system. Each system should be individually designed and installed based on the responsibility and decisions of the purchaser. This guide is not a substitute for contacting Asahi/America for specific recommendations on a system. In addition, Asahi/America is not responsible for items not appearing in the guide or recommendations that may have changed after the printing of this guide. It is recommended in each case to consult Asahi/America for specific recommendations on each system.

Copyright © 2013 Asahi/America, Inc. All rights reserved. Printed in USA.

ABOUT THE COMPANY

Asahi/America, Inc. a wholly-owned subsidiary of Asahi Organic Chemical, pioneered the market for thermoplastic valves and piping in the United States and Latin America, during a time when there was no viable alternative to metal for piping systems. Asahi/America began by promoting valves from a company known as Asahi Organic Chemical Industry Co., Ltd. (AOC) and piping through AGRU GmbH in Austria. Through distributor and end user education and acceptance, the use of thermoplastics has grown. Asahi/America now manufactures and distributes thermoplastic products including valves, actuators, single and double wall piping systems and specialty components throughout the US and Latin America.

Asahi/America is a diversified ISO9001:2015 certified manufacturer and supplier of corrosion resistant fluid flow products. Headquartered in Lawrence, Massachusetts, where we operate a 200,000-square-foot manufacturing and warehouse facility, Asahi/America supports all of our products with a comprehensive selection of in-depth technical documents and product catalogs. To access any of Asahi/America's technical documentation, testing information, or product catalogs, visit the company's website at www.asahi-america.com or contact customer service at 1-800-343-3618.

What makes Asahi/America special is our ability to provide solutions for corrosive or high purity fluid handling systems individualized to meet virtually any customer's need. The Asahi/America technical staff is able to provide superior knowledge of products, applications and installations. Asahi/America is poised to support your next project with the assistance of our large distribution network.

Asahi/America is proud to present this Engineering Design Guide to you. This publication represents over 40 years of experience, talent, and engineering expertise. It is intended to aid in the process of engineering, specification, and design of industrial plastic piping systems using the family of Asahi plastic piping systems. We encourage you to use it often and call upon our staff of piping and valve engineers if there is something we have neglected to cover. This is your guide to quality plastic system design.

**Another
Corrosion
Problem
Solved.™**



A	Introduction	Plastics in Fluid Handling Thermoplastics at a Glance	
B	Materials	General Properties Specific Properties	
C	Basic Calculations	SDR - Standard Dimension Ratio Operating Pressure Dangerous Media Operating Pressure Permissible Wall Thickness External Pressure Calculations	
D	System Calculations	Pressure Curve Graphs Creep Curves Vacuum Pressure Charts Abrasion Resistance General Chemical Resistance Leach Out Behavior Surface Roughness Production and Packaging Storage and Transportation	
E	General Installation Practices	Bending Socket Butt/IR Electrofusion Hot Air Mechanical Connections	
F	Special System Considerations	High Purity Industrial Double Contained Ventilation Compressed Air	Purad [®] , PolyPure [®] , PP-Pure [®] Proline [®] , Chem Proline [®] , Ultra Proline [®] Duo-Pro [®] , Chem Prolok [™] , Fluid-Lok [®] PuradVent [®] , ProVent [®] Air-Pro [®]
G	Design & Pressure Testing	Single Contained Double Contained	

Introduction

A

Materials

B

Basic Calculations

C

System Calculations

D

General Installation Practices

E

Special System Considerations

F

Design & Pressure Testing

G

Appendix A - System Tables

A

Appendix B - General Engineering Tables

B

Appendix C - Conversion Tables

C

INTRODUCTION

Contents

Plastics in Fluid Handling A-2

Thermoplastics at a Glance A-3

PLASTICS IN FLUID HANDLING

Plastic piping systems are offered in a wide assortment of materials and sizes. Each material has unique and specific mechanical properties. These diverse properties allow plastic to become the preferred system for many applications that range from the transport of aggressive chemicals to the distribution of ultra pure water.

Because each material has its own unique properties, understanding them becomes vital to the successful design, installation, and operation of a system.

Asahi/America is proud to present this design guide to assist design engineers and system installers with the proper engineering, layout, and installation of plastic systems. Asahi/America is a pioneer in the manufacture and distribution of plastic systems in the United States. Since the 1970's, we have dedicated ourselves to assisting our customers in achieving the maximum benefits plastic systems offer. Designing a system made of thermoplastic materials differs considerably from that of metallic materials. No one understands this as well as Asahi/America's sales and technical staff. Our trained staff is available to assist with all aspects of plastic piping systems. The information contained herein is designed to minimize the efforts of engineers, designers, contractors, and research professionals in sizing and selecting all aspects of fluid systems.

The Plastic Benefit

For pipe, fittings, and valves, thermoplastic materials offer superior corrosion resistance, lighter weight, simple installation, and a more cost-effective alternative.

Corrosion Resistance

Plastics are non-conductive and are therefore immune to galvanic or electrolytic erosion. Because plastics are corrosion resistant, pipe can be buried in acidic, alkaline, wet or dry soils without requiring a protective coating. In addition, cathodic protection devices are not required.

Chemical Compatibility

Impervious to many chemicals, thermoplastics are gaining an ever-increasing acceptance and preference in a large variety of applications. Additionally, the variety of materials available allow a wide range of chemical solutions to be handled successfully with plastic piping.

Thermal Conductance

All plastic piping materials have low thermal conductance properties. This feature maintains more uniform temperatures when transporting fluids in plastic

than in metal piping. Low thermal conductivity of the plastic piping wall may eliminate or greatly reduce the need for pipe insulation to control sweating.

Low Friction Loss

Because the interior surface of plastic piping is generally very smooth, less power may be required to transmit fluids compared to other piping systems. Furthermore, the excellent corrosion resistance of plastics means that the low friction loss characteristic will not change over time.

Long-term Performance

Due to the relative chemical inertness and the minimal effects of internal and external corrosion, there is very little change in plastic piping's physical characteristics over the decades. Examinations of pipe samples taken from some systems have shown no measurable degradation after 25 years of use. In most cases, Asahi/America pipe systems are designed for 50 years of service.

Light Weight

Many plastic piping systems are about one-sixth the weight of steel piping. This lends to lower costs in many ways: lower freight charges, less manpower, simpler hoisting and rigging equipment, etc. This characteristic has allowed unique, cost-effective installation procedures in several applications.

Variety of Joining Methods

Plastic piping can be joined by numerous methods. Each material has several different joining methods. The following list incorporates some of the most common:

- Solvent cementing
- Socket fusion
- Butt fusion
- Non-contact IR fusion
- Threaded joints
- Flanges
- O-rings
- Rolled grooves
- Mechanical compression joints

The various joining methods allow plastic piping to be easily adapted to most field conditions.

Nontoxic

Plastic piping systems have been approved for potable water applications, and certain systems are recognized by the FDA as appropriate material to be in contact with food stuff. As evidence, all plastic potable water-piping materials and products are tested and listed for compliance to ANSI/NSF Standard 61. All ASTM and AWWA standards for plastic pressure piping that could be used for potable water contain a provision whereby the regulatory authority or user can require product that has been tested and found to be in conformance with ANSI/NSF Standard 61—Drinking Water System Components—Health Effects. When plastic pipe or fittings are ANSI/NSF Standard 14 listed, and have the NSF-pw (potable water) mark, they also meet the ANSI/NSF Standard 61 requirements. The NSF-pw mark certifies to installers, users, and regulators that the product meets the requirements of ANSI/NSF Standard 14 for performance and the ANSI/NSF Standard 61 for health effects.

Biological Resistance

To date, there are no documented reports of any fungi, bacteria, or termite attacks on any plastic piping system. In fact, because of its inertness, plastic piping is the preferred material in deionized and other high purity water applications.

Abrasion Resistance

Plastic piping materials provide excellent service in handling slurries such as fly ash, bottom ash, and other abrasive solutions. The material toughness and the smooth inner-bore of plastic piping make it ideal for applications where abrasion resistance is needed.

Low Maintenance

A properly designed and installed plastic piping system requires very little maintenance because there is no rust, pitting, or scaling to contend with. The interior and exterior piping surfaces are not subject to galvanic corrosion or electrolysis. In buried applications, the plastic piping is not generally affected by chemically aggressive soil.

THERMOPLASTICS AT A GLANCE

PVC (Polyvinyl Chloride). Asahi/America uses an unplasticized PVC polymer in all of its PVC valves. PVC has excellent chemical resistance, strength, and rigidity. It resists attack from most acids and strong alkalis, as well as gasoline, kerosene, aliphatic alcohols and

hydrocarbons, and salt solutions. Aromatic, chlorinated organic compounds and lacquer solvents do affect PVC chemical properties. Its low cost and overall property balance make PVC material best suited to the widest number of corrosive applications. Its temperature limit is 140°F (60°C).

CPVC (Chlorinated Polyvinyl Chloride). The properties and advantages of CPVC are very similar to those of PVC; however, its working temperature range is higher (195°F/90°C) than that of PVC. It should be specified that in instances where hot corrosive liquids are being handled, an extra margin of safety is required.

PE (Polyethylene). PE is produced from the polymerization of ethylene. High-density PE (HDPE), on the other hand, usually has a specific gravity of 0.941 to 0.959 g/cc. Polyethylene can be used in low temperatures (32°F or colder) without risk of brittle failure. Thus, a major application for certain PE piping formulations is for low temperature heat transfer applications such as radiant floor heating, snow melting, ice rinks, geothermal ground source heat pump piping, and compressed air distribution. These properties also make PE ideal for many single and double wall water reclaim systems.

PP (Polypropylene). A member of the polyolefin family, PP is one of the lightest plastics. It has excellent chemical resistance to many acids, alkalis, and organic solvents. PP is one of the best materials to use for systems exposed to varying pH levels; many plastics do not handle both acids and bases as well. It is not recommended for use with hydrocarbons and aromatics. Its upper temperature limit is 195°F (90°C).

PVDF (Polyvinylidene Fluoride). This high molecular weight fluorocarbon has superior abrasion resistance, dielectric properties, and mechanical strength. These characteristics are maintained over a temperature range of 32°F (0°C) to 250°F (121°C), with a limited usage range extended to 302°F (178°C). In piping systems, PVDF is best suited for systems that operate from 0°F (-17.8°C) to 250°F (121°C). PVDF is highly resistant to wet or dry chlorine, bromine and other halogens, most strong acids, aliphatics, aromatics, alcohols, and chlorinated solvents. Because of its extremely low amounts of extractables, PVDF is widely used to transport ultra pure water in the semiconductor and pharmaceutical industries.

E-CTFE (Ethylene Tetrafluoroethylene). E-CTFE fluoropolymer is commonly known by its trade name Halar[®]₁. E-CTFE is essentially a 1:1 alternating copolymer of ethylene and CTFE (chlorotrifluoroethylene). It contains about 80 percent CTFE, one of the most chemically resistant building blocks that can be used to make a polymer. However, CTFE homopolymers are difficult to fabricate, extrude, or mold. By the copolymerization with ethylene, E-CTFE displays much of the chemical resistance of CTFE when processed. It provides excellent chemical resistance handling applications that almost all other materials do not. In particular, E-CTFE demonstrates effective handling of fuming acids and chlorinated bases. It is likely the best material for handling high concentrations of sodium hypochlorite. Additionally, E-CTFE has good electrical properties and a broad-use temperature range from cryogenic to 300°F (150°C). E-CTFE is a strong material with excellent impact strength over its broad-use temperature range. E-CTFE also maintains useful properties when exposed to cobalt 60 radiation at dosages of 200 megarads. It is one of the best fluoropolymers for abrasion resistance.

PFA (Perfluoroalkoxy). PFA is impervious to almost all known chemicals. PFA is a melt processible fluoropolymer which allows conventional injection molding and extrusion production methods to be utilized. PFA has excellent chemical resistance at high temperatures, even up to 350°F (175°C). Asahi/America uses high purity resins which lend to preferred use in ultra critical applications.

Further Considerations When evaluating the suitability of plastics for your application, you should know and understand which resin is being used and its effects. The effects of stabilizers and copolymerization differ by material. Furthermore, a desired material effect for one application may be undesirable for another. PVC is a prime example of this. In order to be produced, pure PVC requires the addition of stabilizers. These stabilizers allow PVC to be molded, extruded, and strengthened. For simple plumbing, some chemical distribution, and other applications, this is acceptable and desired. However, these same stabilizers make PVC unusable for higher quality, ultra pure water applications because they contribute to the water's contamination through leaching extractables.

All plastic piping systems begin with the production of resin. Some resin, such as Solef[®] PVDF, is pure having been produced without any additives. Others, such as PVC, must have stabilizers added to make them suitable for pipe and fitting production.

High Purity PVDF Resin

Not all PVDF resin is the same. As a polymer, resin can differ by the length of the polymer and its molecular weight. While maintaining similar chemical compatibility, resins of different molecular weight have different mechanical properties, welding characteristics, and melt flow indexes (MFI). Manufacturers intentionally use resin with slightly different polymer structures for their pipe, fittings, and valves. The reason for this is simple; when extruding pipe, it is desirable to use a polymer with a lower MFI, which easily maintains its form as it exits the extruder. Conversely, fitting resin is required to freely flow through the mold and evenly fill the entire internal cavity. Therefore, a high MFI is desired. If a manufacturer uses resins with large differences between the MFI in its fittings and pipe, the overall integrity of the system becomes reduced. Pipe and fittings do not weld together properly, and the mechanical properties may be extremely different. Therefore, the science of polymer pipe system manufacturing is to develop the skill and expertise to manufacture with resins of the closest MFI without sacrificing product quality. Purad[®] achieves this through the use of high purity 1000 Series Solef[®] resins by Solvay. Purad[®] exclusively offers its system of resin with the closest MFI and is produced by the same manufacturer. Furthermore, manufacturing and packaging of high purity PVDF resin is an important factor in the overall quality of PVDF components. The purity of its components essentially begins with the resin. Solvay understands this important fact and carefully manufactures and packages Solef[®] 1000 Series resin with the strictest attention to high purity concerns. Asahi/America and AGRU's Purad[®] Systems are designed for a variety of applications from ultrapure water to aggressive chemical distribution. Purad[®] PVDF offers a broad range of chemical resistance and temperature operation.

1. Halar is a registered trademark of Ausimont Corporation.

2. Halar[®] E-CTFE Fluoropolymer Chemical Resistance Data; Ausimont USA, Inc., Technical Data Brochure.

MATERIALS

Contents

General Properties	B-2
Specific Properties	B-11

GENERAL PROPERTIES

Overview of Materials

Polypropylene (PP), polyethylene (PE), PVDF, and Halar® are superior materials in terms of resistance to environmental corrosive agents. All materials are resistant to a wide variety of organic and inorganic chemicals of high concentrations and temperatures. PP and PE are members of the polyolefin plastics family, have excellent chemical inertness, resistance to moisture flow, and complete resistance to attack by ambient moisture. They are not affected by detergents and most inorganic chemicals or organic solvents below 180°F (82°C) and 140°F (60°C), respectively. However, both PP and PE are affected by halogens, fuming nitric and sulfuric acids, and other highly oxidizing environments. Aromatic and chlorinated hydrocarbons tend to cause swelling and softening at elevated temperatures, as well. Polypropylene has a high temperature resistance, making it more suitable for a wider range of chemical process applications. PP is generally suitable up to a maximum temperature of 180°F (82°C). High density polyethylene is rated to a maximum operating temperature of 140°F (60°C). HDPE (class and resin dependent) is a ductile material, making it preferable for lower temperature application.

PVDF and Halar® are members of the inert fluoropolymer family. PVDF is made from polyvinylidene fluoride and has even greater chemical inertness and

resistance to moisture flow than PP and PE. PVDF resists many corrosives, including inorganic substances such as mineral acids with very low pHs up to operating temperatures of 280°F (138°C). It shows excellent resistance to halogens, strong oxidants, and ultra pure water solutions. It is affected by strong baseous solutions, members of the amine family, and is not recommended for highly polar solvents such as ketones or esters. Halar® (E-CTFE) is resistant to the widest selection of chemical media. It is perfectly suitable for strong acids and bases, halogens, and ultra pure water. It does have a reduction in resistance to certain ketones. Halar® has the highest temperature rating of 300°F (138°C) for continuous operation.

Asahi/America has a very detailed corrosion resistance database available for these specific products, which includes over 600 corrosive solutions at a variety of concentrations and operating temperatures. At all times, refer to the specific chemical resistance guide for each product. Asahi/America. databases all of its chemical projects. Chemical verifications conducted by resin manufacturers are also kept on file for reference. When using aggressive chemicals or multiple chemical mixtures, consult Asahi/America for a written recommendation on the specific application. To receive a documented recommendation, submit the chemical concentration, temperature, and operating pressure to the Asahi/America Engineering Department. A formal response is typically generated in one week or less.

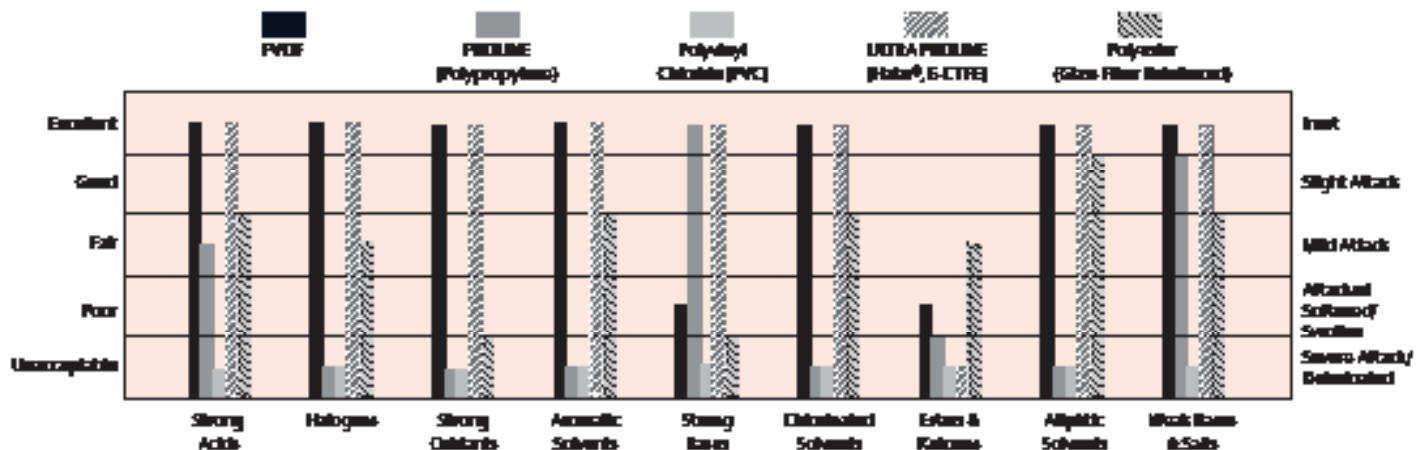

Figure B-1. General comparison of chemical performance of various plastic piping materials

General Nature of Corrosion and Plastics

Chemical resistance varies greatly between any two particular families of plastics. Within a given family, there are also differences between any two particular plastics. To compound the matter further, chemical resistance will vary slightly between different grades of a particular plastic or between resins made by different manufacturers. A specific plastic will vary slightly with respect to molecular weight, distribution, degree of crystallinity, amount of internal plasticization that may be present (copolymerization), and other properties. Therefore, it is not suggested that general chemical resistance tables be used for determining the chemical resistance of a given manufacturer's resin. In addition, it is strongly recommended to avoid extrapolating a plastic under the notion that it is chemically similar to another in its family. It is recommended that a specific manufacturer's chemical resistance table be consulted for the particular product, such as the Asahi/America tables for Asahi/America products.

The manner in which a type of chemical might affect a plastic also varies because differing chemicals produce differing reaction mechanisms when interacting with a plastic material. Depending on the reaction mechanism, an effected plastic may become brittle, softened, charred, crazed, delaminated, discolored, dissolved, blistered, or swelled. The reaction mechanisms that produce these types of effects can be grouped into major categories: chemical reaction, solvation, absorption, plasticization, and environmental stress cracking. Combinations of these reaction mechanisms do occur, and when they do, the detection is more complex. Chemical reaction is a very general heading and can be broken down into many distinct categories. Some of these include: oxidation (where chemical bonds are attacked), hydrolysis (not possible for PP, PE, PVDF, and E-CTFE), dehydration (mostly caused by heat), alkylation, halogenation, radiation, and others. Certain reactions are predictable due to the resin's chemical structure. However, attack usually occurs in a complex manner with respect to polymers, which suggests that testing be performed under actual conditions in order to make a decision on performance.

Criteria for Material Selection

There are several conditions that bear particular importance on the individual chemical attack mechanisms, and therefore have a great effect on the selection process. The conditions of direct importance

include: temperature, type of corrosive reagent to be handled, the particular reagent's concentration, and the system's operating pressure.

The Effect of Temperature

Temperature has a significant effect on all of the attack mechanisms. The attack will almost always be directly related to temperature; increased temperature results in an increased attack on the plastic material. Not only does a temperature increase result in a lowering of the activation energy required for a reaction to proceed, but it also causes a polymer to expand. This results in an increase in permeability, penetrability, and solubility characteristics of the polymer, which aid in a combination of the different mechanisms.

One important point should be noted regarding temperature. As a plastic increases through its temperature profile, there may be a certain transition temperature where the basic stress crack mechanism may be altered appreciably. The significance of this fact is that trying to extrapolate from known performance at a low temperature to a high temperature may lead to erroneous results. A particular danger exists if a data point is presented at ambient temperature only and an attempt is made to make a prediction near the polymer's design temperature limit.

The Effect of Concentration

There are many families and types of reagents, each with different properties concerning solubility, reaction between other chemical groups, etc. Each will present a slightly different concern because of different attack mechanisms that they can trigger, except a given polymer type. The reagent's concentration will also pose a concern and can result in differing reaction rates at differing concentration levels. This is true for a variety of complex reasons. Of particular concern is the mineral acids group. This group can show substantially different effects at various levels on the concentration profile. Again, importance must be given to the concentration effect because temperature causes great concern. A level of concentration can be obtained when suddenly a transition is achieved and the stress cracking mechanism can show substantial change. Extrapolating results caused by known concentrations is a very dangerous practice and is strongly discouraged. The more data points available, the better the prediction. However, testing is always recommended if performance is not known.

Manufacturing Effect

The way a product is manufactured can induce molded-in stresses that produce changes in chemical resistance, particularly environmental stress cracking. Manufacturing can also produce surface irregularities that vary by manufacturer. In general, a smoother surface will show better results. Built-in stress due to poor extrusion methods will decrease a system's overall chemical resistance. Temperature, pressure, and chemical attack all add to a system's stress level. If the amount of stress exceeds the allowable hoop stress, environmental stress cracking will occur. It is, therefore, necessary to carefully review all the parameters of an application.

Chemical Attack Mechanisms

Chemical Reaction Mechanism

Chemical attack by chemical reaction can proceed along the paths of any of the types of reactions described earlier, depending on the given chemical and plastic. If the active sites attacked are along at the ends of the polymer chain, a chain reaction may be initiated leading to a complete "unzipping" of the polymer structure. If the sites are distributed, then the polymer will become scissioned or separated at the distribution sites. This will lead to a chemical breakdown of the polymer. Detecting a chemical reaction occurrence through testing depends on the rates that these reactions can occur. The typical properties include molecular weight, dimensions, and overall appearance, as well as short-term properties, such as tensile strength, elongation, flexural properties, and others.

A rapid reaction can easily be detected through a change in molecular weight, color, appearance, etc. A slower reaction is better detected by the changes in the previously mentioned short-term mechanical properties. Quantifying these results is challenging to the designer. When a plastic's properties change it is no longer suitable for a given application. Pay close attention to the tensile creep rupture tests because this data is the most important aspect in analyzing design strength of a plastic piping system.

Solvation Mechanism

Solvation effect on a thermoplastic usually manifests itself by swelling of the plastic, as well as weight and dimensional changes. Simple tests similar to those described for chemical attack can easily detect these

changes. Asahi/America materials are very stable because of their high molecular weights and stable molecular structures, and therefore are not subject to solvation by many known common solvents.

Plasticization

Plasticization typically occurs as an imperfect solvent and is selectively absorbed into the surface of the product. It incorporates itself into the molecular structure of the molecule through secondary bonding. This typically lowers the mechanical properties and the glass-transition temperature. The plastic might also tend to get heavier or larger, but this should only be used as an indication of the effect. It is more important to measure the mechanical properties and the glass-transition temperature.

Environmental Stress Cracking Mechanism

When a plastic is subjected to stresses, it may experience catastrophic failure due to the initiation and propagation of cracks and crazes. This process is known as environmental stress cracking and is inherently difficult to predict. It is assumed that the surface of the plastic is weakened by the reagent's chemical action. As this localized weakening takes place, it cracks, creating greater surface area while also acting as a stress concentrator. The effect is, therefore, multiplied, and further failure occurs until the inevitable catastrophic failure results.

A crack may appear through selective absorption of the reagent into the polymer chain, selective solvation of polymer by the reagent from localized areas, or complexing along the polymer chain at localized sites. No matter which selective mechanism, the result is always a weakening of the localized area that results in an initial failure, followed by crack propagation. The result of the crack propagation is described above – greater surface area and stress concentration with subsequent catastrophic failure. To test for environmental stress cracking, both exposure and stress must occur at the same time in order to reveal the mechanism. Because this is the most important mechanism in piping performance, the following three tests are used to detect this phenomenon:

- Creep rupture test
- Cantilever beam test
- Stress-relaxation test

**Testing for Environmental Stress Cracking
Creep Rupture Test**

To test for environmental stress cracking, the basic test for tensile creep (ASTM D-2990) is modified to produce the desired results. To conduct tests under ambient temperatures, a set up similar to Figure B-2 can be used. To conduct measurements of creep strain and rupture at a variety of temperatures, a test set-up similar to Figure B-3 might be adapted. In this set-up, the encasing stainless steel outer pipe could be immersed into a constant temperature bath.

The advantage of this test is that stress crack resistance is measured as a direct variable in terms of the plastic's reduction in design strength (stress). In addition, the expected service life could be determined by these results.

Cantilever Beam Test

The cantilever test is simpler than the creep rupture test. It is valid primarily when short exposure times are required and when the material does not show significant creep. It is an excellent test for large numbers of test specimens. A suggested test set-up is shown in Figure B-4.

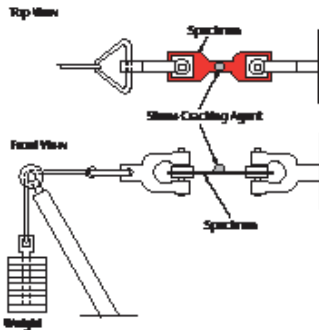

Figure B-2. Detail of creep rupture test (ambient temperatures)

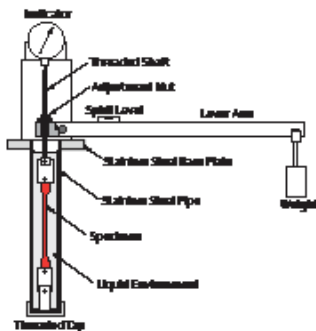

Figure B-3. Detail of creep rupture test (elevated temperatures)

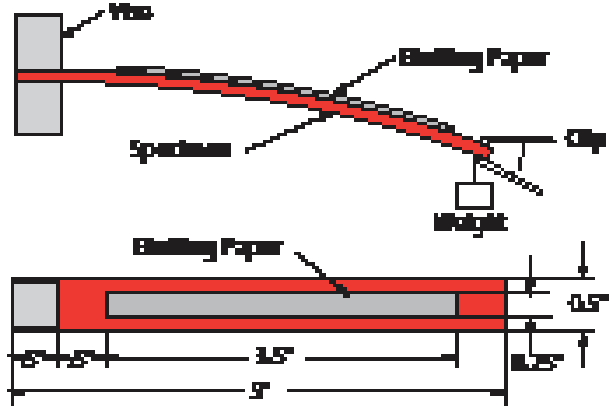

Figure B-4. Detail of cantilever beam test for environmental stress cracking (room temperature)

In the test, the reagent is applied to blotted paper, and the beam is bent by the clip attached to the end. Initially, trial and error is used to determine a weight that will cause cracking near the bar's mid-point. Stress and strain will vary in a cantilevered beam from zero at the free end to the maximum at the clamped end. Cracks will, therefore, appear from the free end until the combination of stress cracking reagent and stress reach the critical stress and strain point. The following formulae can be used to determine critical stress and strain:

$$S_c = \frac{6FL}{bt^2} \tag{B-1}$$

Where:

- S_c = critical stress (psi)
- F = weight (lb)
- L = critical distance (measured from free end (in))
- b = width of the bar (in)
- t = thickness of the bar (in)

$$\epsilon = \frac{S_c}{E} \tag{B-2}$$

Where:

- ϵ_c = critical strain (in/in)
- E = short-term flexural modulus (psi)

Stress-Relaxation Test

A third alternative is to test a specimen under stress by subjecting it to a fixed deflection. This test eliminates the need for weights and takes up little space. A suggested set-up is shown in Figure B-5.

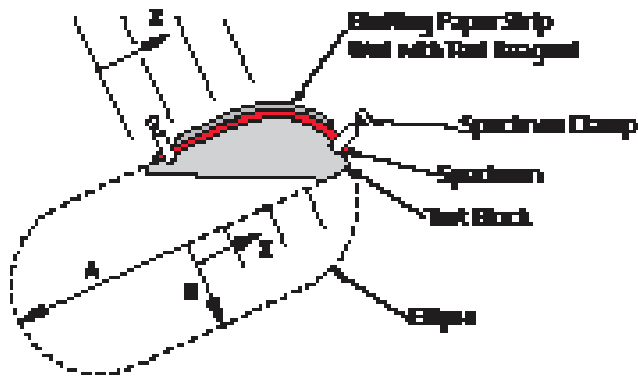

Figure B-5. Detail of stress-relaxation test

The test is limited to more flexible plastics and situations with shorter stress cracking due to stress-relaxation. To calculate critical strain where stress cracking first appears, use the following equation:

$$\epsilon_c = \left[\frac{bt}{2a^2} (1-x^2) \left(\frac{1}{a^2} - \frac{b}{a^4} \right) \right] \quad (B-3)$$

Where:	ϵ_c	=	critical strain (in/in)
	a	=	semi-major axis of ellipse (in)
	b	=	semi-minor axis of ellipse (in)
	x	=	distance along major axis (in)
	t	=	thickness (in)

PE General

General properties of PE (Polyethylene)

As PE molding materials are continually developed, the efficiency of PE pipes and fittings have been improved considerably. This fact is due to the introduction of new international standards (ISO 9080, EN1555, EN12201), which lead to higher permissible operating pressures. Polyethylene (PE) for pressure pipe applications is no longer classified by its density (for example PELD, PE-MD, PE-HD); it is now divided into MRS strength classes.

Compared to other thermoplastics, PE shows an excellent diffusion resistance and has, therefore, been used to safely transport gases for many years. The new classification is based on the minimum required strength

(MRS), which is applied to design long-term loaded PE pipes that operate at a temperature of + 68° F (20°C) for at least 50 years. Therefore, the first-generation pipes are named PE32, PE40, and PE63; the second-generation pipes are labeled PE80; the third generation is named PE100. The figures stand for the MRS values in bar. Expressed in megapascal, the design stresses for PE80 and PE100 pipes will consequently be 8.0 and 10.0 MPa.

Other essential advantages of this material are the UV-stability (if it is black) and the flexibility of the molding material (flexible piping system).

Chemical structure of PE

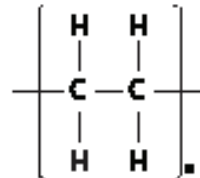

Physiologically non-toxic

Polyethylene's composition complies with relevant food stuff regulations (according to FDA CFR21, ÖNORM B 5014, Part 1, BGA, KTW guidelines). PE pipes and fittings are verified and registered for potable water suitability according to DVGW guideline W270 and NSF 61-G.

Radiation strain

Pipes made of polyethylene may be applied across the range of high-energy radiation. Pipes made from PE are suitable for radioactive sewage water drainage from laboratories and as cooling water piping systems for the nuclear energy industry. Radioactive sewage waters usually contain beta and gamma rays. PE piping systems do not become radioactive, even after many years of use. Also, in a higher radioactivity environment, PE pipes are not damaged if they are not exposed during their complete operation time to a larger, regularly spread radiation dose of < 10⁴ Gray.

Polyethylene type PE100

These materials are also described as third generation (PE-3) polyethylene types and MRS 10 materials. A modified polymerization process and amended mol mass distribution shows this development. Therefore, PE100 types have a higher density, stiffness, and hardness. Also, the creep pressure and resistance against rapid crack propagation are increased.

Consequently, this material is suitable for the production of pressure pipes with larger diameters. In comparison to usual PE pressure pipes with less wall thicknesses, it achieves the corresponding pressure rating.

Modified polyethylene PE-el (Polyethylene, electro-conductible)

Due to electro-conductibility, PE-el is often used to transport easily combustible media or to convey dust. An earthed connection can be performed.

Advantages of PE:

- UV-resistance (black PE)
- Flexibility
- Low specific weight of approximately 0.95g/cm³
- Favorable transportation (e.g., coils)
- Very good chemical resistance
- Weathering resistance
- Radiation resistance
- Good weldability
- Very good abrasion resistance
- No deposits and no overgrowth possible due to less frictional resistance
- Less pressure
- Losses in comparison with metals, etc.
- Freeze resistance
- Rodent resistance
- Microbic corrosion resistance

PP General

Proline® (industrial grey), PP-Pure® (high purity PP grey) and PolyPure® (high purity PP natural) piping systems are made out of specially selected polypropylene material PPR (polypropylene random-copolymer). These are thermoplastic materials that distinguish themselves by a low specific weight and excellent processibility, weldability, and formability. These materials contain additives (e.g., stabilizers) but no plasticizers.

General properties of PP

According to DIN 8078, three different types of polypropylene are recognized:

- Type 1: PPH (homopolymere)
- Type 2: PPB (block-copolymere)
- Type 3: PPR (random-polymere)

Copolymerization with ethylene creates special properties, which results in improved processability (e.g. lower danger of shrinkage cavitation at the injection molding process) and higher product impact strength compared to PPH polypropylene homopolymer. Therefore, PP-Pure® and PolyPure® are especially suitable in the chemical and semiconductor industry for UPW-systems where chemical resistance is imperative.

AGRU pipes, sheets, and round bars have been made of nucleated PPH (Beta (β)-PP) since the mid-1970s. Fittings have also been produced out of PPR (polypropylene random-copolymer) since the end of the 1970s. Both types have been stabilized against high temperatures and are the best suited materials for the production of pressure piping systems. In comparison to other thermoplastics such as PE and PVC, PP shows a thermal stability up to 212°F (100°C) (short-time up to 250°F (120°C) for pressureless systems).

PP also shows good impact strength in comparison to PVC. The impact strength depends on temperature; it increases with rising temperatures and decreases with falling temperatures.

Chemical structure of Polypropylene

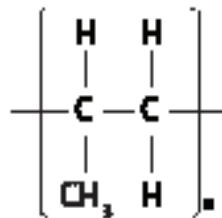

Physiological non-toxicity

Polypropylene's composition complies with the relevant food stuff regulations (according to ÖNORM B 5014 part 1. FDA. BGA. KTW guidelines).

Advantages of Polypropylene:

- Low specific weight of 0.91 g/cm³ (PVC 1.40 g/cm³)
- High creep resistance
- Excellent chemical resistance
- High resistance to aging due to thermal stabilizing
- Good weldability
- Excellent abrasion resistance
- Smooth inside surface

- No deposits and no overgrowth
- Less frictional resistance
- Non-conductive
- Good insulating characteristics
- Energy-rich radiation

Radiation strain

At an absorbed dose of $< 10^4$ Gray, polypropylene piping systems can be applied without decreasing essential resistance. At energy rays above 10^4 Gray, temporary resistance may increase due to the molecular structure cross-linking. But at durable radiation strain, it ruptures the molecular chains and damages the material to a serious resistance decrease.

UV radiation

Polypro piping systems are not UV-stable, so they must be adequately protected. A protection layer or insulation is possible to protect against direct solar radiation. For pigmented systems, it is possible to compensate the surface damage by increasing wall thickness, as the damage only occurs on the surface (according to the DVS 2210-1). The wall thickness addition cannot be less than 2 mm with a 10 year maximum expected operating period. Because polypropylene is not normally equipped with light-stable color pigments, it may change colors (fade) due to weathering.

As an alternative, a high temperature resistant, black PP material can be used. The black PP material is stabilized against UV radiation for 10 years. The conditions for application should be clarified with the technical engineering department.

Discoloration of PolyPure®

At higher temperatures, a discoloration of the material appears, but this has no influence on the product's performance with regard to its mechanical, thermal, purity, or electrical properties.

PPR and copper

Direct contact with copper, especially at higher temperatures, deteriorates the physical properties of PPR. Due to the accelerated thermal oxidation, heat aging is faster.

General properties of modified PP

Flame retardant (PP-s) and electro-conductive (PP-el) have been developed because of an increase in new specific requirements for the construction of piping

systems for the chemical industry and apparatus engineering. For example, static charging caused by the flow of fluids or dust can arise during the operation of thermoplastic piping systems. Electro-conductive polypropylene types have been developed in order to enable an earth connection. These modified properties are achieved with the supplement of additives, but this results in alterations to the mechanical, thermal, and chemical properties in comparison to the standard type. Therefore, it is necessary to clarify all projects with our technical engineering department.

Physiological properties

Modified PP types (flame retardant and electro-conductive PP) correspond in composition because of the supplement of additives and not because of the relevant food stuff regulations. Therefore, they may not be used for potable water pipes and in contact with food stuff.

PVDF General

General properties of PVDF (Polyvinylidene fluoride)

PVDF is an extremely pure polymer and contains no UV stabilizers, thermostabilizers, softeners, lubricants, or flame retardant additives. It is particularly suitable for ultra pure water constructions and for the transport of clear chemical liquids in the semiconductor industry.

Due to its chemical inertness, reaction against most media is nearly impossible. Pipes and components made out of suitable standard types fulfill the high demands of the semiconductor industry; for example, they are in the position to maintain the specific resistance of deionized ultra pure water over $18 \text{ M}\Omega\text{cm}$. PVDF offers an ideal compromise with its properties, in connection with very easy processing and an advantageous price-performance ratio.

PVDF is distinguished by its high mechanical strength and very good chemical resistance, even for applications in the presence of critical chemical media in the high temperature range.

Chemical structure of PVDF

PVDF is obtained by the polymerization of vinylidene fluoride, and it corresponds to the following chemical structure:

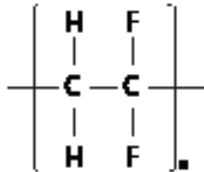

The two main processes to produce PVDF are:

- The emulsion polymerization process
PVDF type I according ASTM D 3222
- The suspension polymerization process
PVDF type II according ASTM D 3222

PVDF material that is produced through the suspension polymerization process offers fewer structural defects, resulting in higher crystallinity as well as better mechanical properties and long-term behavior. Purad® uses only suspension PVDF in order to provide the best possible product quality.

Fire resistance

PVDF UHP is a halogen-containing polymer, which offers excellent fire protection without flame retardant additives. During the combustion of PVDF UHP, only a slight amount of smoke development arises. With an oxygen index of about 44 percent, PVDF UHP received the highest flammability classification V0, according to UL-94.

Physiological properties

PVDF-UHP is physiologically harmless, non-toxic, and conforms to FDA regulations as outlined in Title 21. Chapter 1. Part 177-2510 (contact with food).

Advantages of PVDF:

- Wide application temperature range (-4°F to 248°F)
- High heat deflection temperature
- Very good chemical resistance, even at high temperatures
- Good resistance against UV and γ -radiation
- Pure material without additives
- Very good surface quality
- High aging resistance and good thermal stability

- Excellent abrasion resistance
- Very good anti-friction properties
- Good mechanical properties
- Excellent insulation characteristics
- Flame retardant
- Physiologically non-toxic
- Good and simple processability
- Energy-rich radiation

The effects of gamma (γ) rays on PVDF UHP are significantly lower than in many other halogen polymers (e.g., PFA, PTFE, PVC). PVDF is resistant to highly energetic radiation. This fact makes PVDF suitable for use in the nuclear industry. The cross-linking of the polymer begins with 100 kilogray.

UV radiation

Suspension grade PVDF contains a high percentage of fluorine. The bond between the highly electronegative fluoride and carbon atom is extremely strong, with a dissociation energy of 460 kJ/mol. Therefore, PVDF UHP is resistant to ambient UV radiation (>232 nm).

Solubility

The PVDF-homopolymere swells in high polar solvents, such as acetone and ethylacetat, and is soluble in polar solvents, such as dimethylformamide and dimethylacetamide.

Fluoropolymers**General properties of E-CTFE (Ethylenechlorotrifluorethylene)**

E-CTFE (known as Halar®) has a unique combination of properties as a result of its chemical structure, which is a copolymer with a changing constitution of ethylene and chlorotrifluorethylene.

E-CTFE provides excellent chemical resistance and high mechanical strength, even at high temperatures. These characteristics enable the use of E-CTFE as a cost-effective solution for many applications with ultra pure media.

Furthermore, E-CTFE has an inherent resistance to many aggressive chemicals, even corrosive acids, alkalis, and solvents, and it is also resistant in contact with chlorine. It can withstand pH values from 0 to 14. There are only a few chemicals that affect E-CTFE, such as hot amines, sodium, and potassium.

Chemical structure of E-CTFE

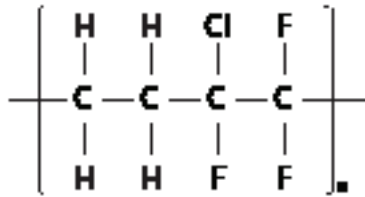

Physiological properties

E-CTFE is suitable for the safe application of products in continuous contact with food stuff, according to the FDA & "BGA Deutschland". For avoiding every influence of smell and taste, it is recommended to use water to clean the food that has direct contact with E-CTFE parts.

Advantages of E-CTFE:

- Wide temperature application range (thermal resistance from -105°F to 340°F (-105°C to 171°C))
- Good resistance to UV and γ -radiation, therefore, favorable aging resistance
- Flame retardant (UL 94-V0 material) - oxygen index 52 percent
- Extremely good chemical resistance to most technical acids, alkalis, and solvents as well as in contact with chlorine
- Excellent insulating properties in connection with very good electrical values
- Physiologically non-toxic
- Exceptional surface smoothness
- Excellent impact strength
- Excellent tensile strength
- Highest creep modulus
- Extremely low permeability
- Excellent abrasion resistance
- Energy-rich radiation

E-CTFE has an extraordinary inherent resistance to gamma (γ) rays. Therefore, E-CTFE is not influenced by the radiation of Cobalt-60 up to 2 MGy.

Fire resistance

E-CTFE has the best flammability resistance (UL 94-V0) and a very low smoke generation of LOI >52 percent.

Surface quality

E-CTFE is distinguished from all other fluoropolymers by its exceptional surface smoothness, which precludes the shedding of particles and avoids particle trapping. The surface of E-CTFE exhibits a low incidence of microbial bio-fouling, making it ideal for use in UPW applications.

UV radiation

E-CTFE shows only a slight change of the properties or appearance weathering in the sunlight. Reaped weathering tests showed a remarkable stability of the polymers, particularly the elongation at break, which is a good indicator for the polymer decomposition. Even after 1,000 hours in a "Weather-Ometer" with xenon light, the important properties are hardly influenced.

Thermal properties

E-CTFE has a remarkable resistance against decomposition through heat, intensive radiation, and weathering. It is resistant against temperatures up to 303°F (150°C) for an extensive length of time, and it is one of the best plastics with a good resistance against radiation.

Radiation resistance

E-CTFE shows an excellent resistance against different radiations. It even has good values after irradiation with 200 megarad Cobalt-60.

Mechanical properties

E-CTFE is a solid, highly impact-resistant plastic that hardly changes its properties over a wide range of temperatures. In addition to the good impact strength, E-CTFE has a good breaking strain and good abrasion behavior. It is also important to emphasize the good behavior at low temperatures, especially the high impact strength.

Reproduction of microorganisms on E-CTFE

The surface of an E-CTFE product is unfavorable to the proliferation of microorganisms. This conclusion is the result of an examination that was executed within the framework of a test of the HP-suitability of E-CTFE. Due to these properties, E-CTFE is applied in the food and drug industry and for ultra pure water ranges.

SPECIFIC PROPERTIES

Specific material properties PE, PP, PVDF, ECTFE

Please see product specifications on www.asahi-america.com

Applications

The table below gives a survey of the different application possibilities of our molding materials.

Range of applications	PP-H	PP-R	PP-s	PP-s-el	PE100	PE-el	PVDF	E-CTFE
Industrial applications								
Piping systems for conveying of chemicals	■	■	■	■	■	■	■	■
Pipes for cooling water systems	■	■	■		■	■		
Pipes for the transport of solids	■	■			■	■	■	■
Piping systems in explosion-proof rooms				■				
High purity water piping systems		■					■	■
Water extraction and water preparation					■			
Pipes for swimming pools	■	■			■			
Protective pipes for district heating systems								
Protective pipes for cables								
Apparatus engineering and vessel construction	■	■	■		■	■	■	■
Ventilation and degassing piping systems	■	■	■	■		■		
Distribution of compressed air					■ *			
Applications for environmental protection								
Pipes for drainage systems	■	■			■			
Dual pipes	■	■			■		■	■
Piping systems for sewage treatment plants and lining	■	■			■			■
Degassing pipes for waste disposal facilities					■	■		
Drainage pipes for landfill sites	■				■			■
Discharge piping systems					■			
Applications for supply systems								
Pipes for irrigation systems					■			
Pipes for potable water systems	■	■			■		■	■
Gas pipes					■			

* Air-Pro System Only

Table B-6. Application Recommendations

BASIC CALCULATIONS

Contents

SDR - Standard Dimension Ratio	C-2
Operating Pressure	C-2
Dangerous Media Operating Pressure	C-3
Permissible Wall Thickness	C-4
External Pressure Calculations	C-5

The following calculations are shown using metric units for simplicity. Asahi/America engineering staff is happy to assist with any questions you may have.

Unit conversion: 1 bar = 14.5psi
25.4 mm = 1 inch

SDR-STANDARD DIMENSION RATIO

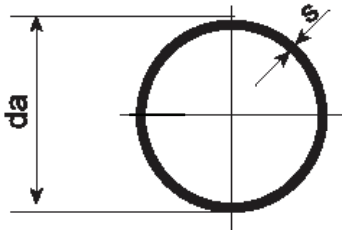

$$\text{SDR} = \frac{da}{s} \quad (\text{C-1})$$

Where:
SDR = Diameter - wall thickness relation
da = outside diameter [mm]
s = wall thickness

Material	Temperature		
	10 to 40°C	40 to 60°C	over 60°C
PE80	1.25		
PE100	1.25		
PPH	1.6	1.4	1.25
PPR	1.25		
PVDF	1.6		
E-CTFE	2.0		

Table C-1. Safety Factor

Example:
da = 110 mm
s = 10 mm

$$\text{SDR} = \frac{da}{s} = \frac{110}{10} = 11 \quad (\text{C-1 Example})$$

S - series

$$s = \frac{\text{SDR} - 1}{2} \quad (\text{C-2})$$

Where: SDR = Diameter - wall thickness relation

Example:
SDR = 11

$$s = \frac{\text{SDR} - 1}{2} = \frac{11 - 1}{2} = 5 \quad (\text{C-2 Example})$$

OPERATING PRESSURE

$$P_B = \frac{20 \cdot \sigma_v}{(\text{SDR} - 1) \cdot C_{\min}} \quad (\text{C-3})$$

Where:
P_B = Component operating pressure [bar]
σ_v = Reference strength [N/mm²]
(see the pressure curve for each material in Section D)
SDR = Standard Dimension Ratio
C_{min} = Minimum safety factor
(see table c-1)

Example:
PE100, 20°C, 50 years, water (σ_v = 10)
SDR = 11
C_{min} = 1.25

$$P_B = \frac{20 \cdot \sigma_v}{(\text{SDR} - 1) \cdot C_{\min}} = \frac{20 \cdot 10}{(11 - 1) \cdot 1.25} = 16 \quad (\text{C-3 Example})$$

DANGEROUS MEDIA OPERATING PRESSURE

Operating pressure for dangerous media

In order to calculate the respective permissible highest operating pressure for conveying dangerous fluids, the operating pressure value can be looked up for the corresponding parameter in the relevant table for permissible system operating pressures (valid for water).

Then, this operating pressure has to be reduced by the relevant reducing coefficients. The total safety coefficient is 2.0 at a minimum. Higher safety coefficients are applied for impact-sensitive modified materials (at HDPE 2.4, PP-s and PP-R-s-el 3.0).

Example:

PE100, 20°C, 50 years, water (d.h. $\sigma_v = 10$)
 SDR = 11
 $C_{min} = 1.25$
 Chemicals: H²SO₄ (sulfuric acid), Concentration 53%
 $f_{CR} = 2.0$ (acc. DVS 2205, part 1)

$$P_B = \frac{20 \cdot \sigma_v}{(SDR - 1) \cdot C_{min}} = \frac{20 \cdot 10}{(11 - 1) \cdot 1.25} = 16 \quad (C-8)$$

$$P_a = \frac{P_B}{f_{AP} \cdot f_{CR} \cdot A_Z} = \frac{16}{1.6 \cdot 2.0 \cdot 1} = 5$$

$$P_a = \frac{P_B}{f_{AP} \cdot f_{CR} \cdot A_Z} \quad (C-7)$$

- Where:
- P_a = Operating pressure of the relevant application [bar]
 - P_B = Component operating pressure, valid for water [bar] (Formula C-3)
 - f_{AP} = Application factor is an additional reducing factor which results in a total safety coefficient of 2.0 at a minimum by multiplication with the C-factors according to DIN. (Table C-2)
 - f_{CR} = Chemical resistance factor according to DVS
 - A_Z = Reducing factor for the specific tenacity (Table C-3)

Reducing factor A_Z for the specific tenacity by low temperatures

Material	Reducing Factor	
	-10°C	+20°C
PE80	1.2	1.0
PE100	1.2	1.0
PE-el	1.6	1.4
PPH	1.8	1.3
PPR	1.5	1.1
PP-s	*	1.7
PPR-s-el	*	1.7
PVDF	1.6	1.4

Table C-3. Reducing Factor

*Not applicable

Application factors f_{AP} for water-dangerous media:

Material	Application factor f_{AP}	C - factor (acc. ISO 12162)	Total safety factor by 20°C ($f_{AP} \times C$)
PE80	1.6	1.3	2.0
PE100	1.6	1.3	2.0
PE-el	1.9	1.3	2.4
PPH	1.3	1.6	2.0
PPR	1.6	1.3	2.0
PPR-el	2.4	1.3	3.0
PPR-s-el	2.4	1.3	3.0
PVDF	1.3	1.6	2.0
E-CTFE	1.0	2.0	2.0

Table C-2. Application Factors

PERMISSIBLE WALL THICKNESS

Calculation of the permissible wall thickness s_{min}

In general, strength calculations of thermoplastic piping systems are based on long-term values. The strength values, depending on temperature, are given in the pressure curves (see Section D). After calculation of the theoretical wall thickness, the construction wall thickness has to be determined under consideration of the nominal pressure and SDR class. Additional wall thickness sometimes has to be considered (e.g., application of PP piping systems outdoor without UV protection for the transport of abrasive media).

$$s_{min} = \frac{p \cdot da}{20 \cdot \sigma_{zul} + p} \quad (C-9)$$

When:

$$\sigma_{zul} = \frac{\sigma_v}{C_{min}}$$

Where:

s_{min}	=	Minimum wall thickness [mm]
p	=	Operating pressure [bar]
da	=	Pipe outside diameter [mm]
σ_{zul}	=	Maximum permitted stress (see pressure curves sec D. [N/mm ²])
σ_v	=	Reference stress [N/mm ²]
C_{min}	=	Minimum safety factor (See Table C-1)

Example:
PE100, 20°C, 50 years, water (d.h. $\sigma_v = 10$)
Operating pressure 16bar
Outside diameter $da = 110$ mm

$$\sigma_{zul} = \frac{\sigma_v}{C_{min}} = \frac{10}{1.25} = 8 \quad (C-10)$$

$$s_{min} = \frac{p \cdot da}{20 \cdot \sigma_{zul} + p} = \frac{16 \cdot 110}{20 \cdot 8 + 16} = 10$$

If necessary, the reference stress (σ_v) and the operating pressure (p) can also be calculated from this formula.

$$\sigma_{zul} = \frac{p \cdot (da - s_{min})}{20 \cdot s_{min}} \quad (C-11)$$

And

$$p = \frac{20 \cdot \sigma_{zul} \cdot s_{min}}{da - s_{min}}$$

$$\sigma_{zul} = \frac{p \cdot (da - s_{min})}{20 \cdot s_{min}} = \frac{16 \cdot (110 - 10)}{20 \cdot 10} = 8 \quad (C-12)$$

EXTERNAL PRESSURE CALCULATIONS

In certain cases, piping systems are exposed to external pressure:

- Installation in water or buried below groundwater table
- Systems for vacuum e.g., suction pipes

$$P_k = \frac{10 \cdot E_C}{4 \cdot (1 - \mu^2)} \cdot \left(\frac{s}{r_m} \right)^3 \quad (C-13)$$

Where:	P_k	= Critical buckling pressure [bar]
	E_C	= Creep modulus [N/mm ²] for t = 25a
	μ	= Transversal contraction factor (for thermoplastics, generally 0.38)
	s	= Wall thickness [mm]
	r_m	= Medium pipe radius [mm]

The buckling tension can then be calculated directly:

Example:

PPR pipe SDR33

40°C, 25 years

$E_C = 220 \text{ N/mm}^2$ (creep modulus curve - page x)

Outside diameter $d_a = 110 \text{ mm}$

Wall thickness = 3.4 mm

Additional safety factor 2.0 (minimum security factor for stability calculation)

$$P_k = \frac{10 \cdot E_C}{4 \cdot (1 - \mu^2)} \cdot \left(\frac{s}{r_m} \right)^3 = \quad (C-14)$$

$$= \frac{10 \cdot 220}{4 \cdot (1 - 0.4^2)} \cdot \left(\frac{3.4}{53.3} \right)^3 = 0.17$$

$$P_k = \frac{0.17}{2.0} = 0.085$$

$$\sigma_k = P_k \cdot \frac{r_m}{s} = 0.085 \cdot \frac{53.3}{3.4} = 1.33 \quad (C-16)$$

SYSTEM CHARTS

Contents

Pressure Curve Graphs	D-2
Creep Curves	D-12
Vacuum Pressure Charts	D-17
Abrasion Resistance	D-18
General Chemical Resistance	D-19
Surface Roughness	D-22
Production and Packaging	D-23
Storage and Transportation	D-24
Installation	D-27

D

Pressure curve for pipes out of PE100
(acc. to EN ISO 15494, supplement B)

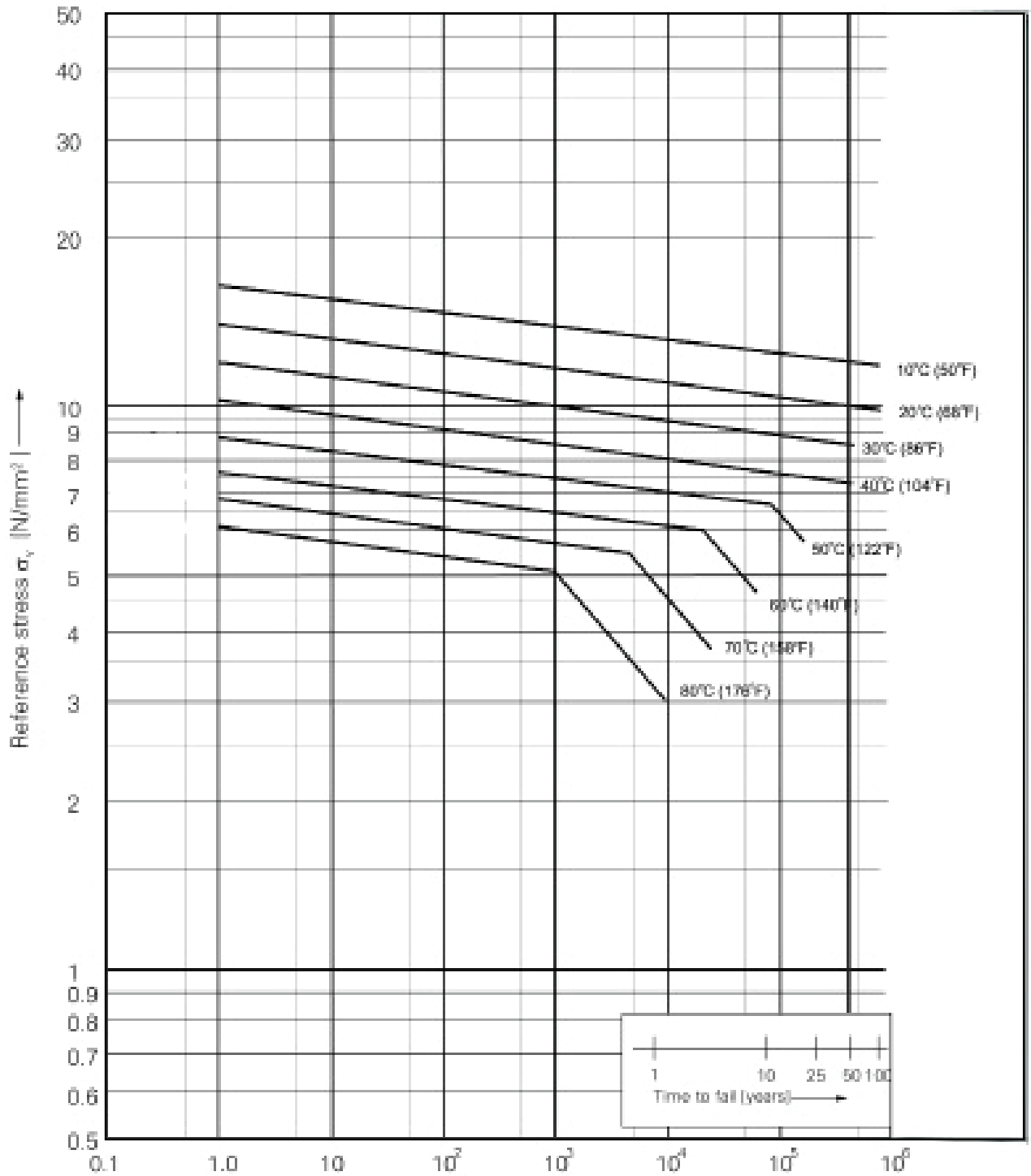

Table D-2. Pressure Curve PE100

Permissible component operating pressures p_B for PE100, depending on temperature and operation period.

In the table below, the data applies to water. They were determined from the creep curve, taking into account a safety coefficient of $C=1.25$.

Temperature °F (°C)	Operating period (years)	Diameter-wall thickness relation SDR										
		41	33	26	17	11	7.4	6				
		Pipe series S										
		20	16	12	8	5	3	2				
PN												
4							5	6.3	10	16	25	32
permissible component operating pressure (psi)												
50 (10)	5	73	91	115	183	293	457	586				
	10	71	90	113	180	287	449	576				
	25	70	87	110	175	280	438	561				
	50	68	85	109	173	275	431	551				
	100	67	84	106	168	271	423	542				
68 (20)	5	61	77	96	154	245	384	492				
	10	59	75	94	151	241	377	483				
	25	58	72	93	146	235	368	471				
	50	58	72	91	145	232	362	464				
	100	57	71	88	142	228	355	455				
86 (30)	5	52	65	81	130	209	326	418				
	10	51	64	80	128	204	320	410				
	25	49	62	78	125	200	313	400				
	50	48	61	77	122	196	307	393				
	104 (40)	5	43	55	70	112	178	280	358			
10		43	55	68	110	175	275	352				
25		42	54	67	107	171	268	344				
50		42	52	65	104	168	264	338				
122 (50)		5	38	48	61	97	155	242	354			
	10	38	46	58	94	151	235	294				
	15	33	42	54	86	138	215	275				
	140 (60)	5	28	35	43	70	112	175	225			
158 (70)		2	22	28	35	57	90	142	181			

Table D-3. Permissible Component Operating Pressure PE100

1. For calculation of the operating pressure in installed piping systems, we recommend multiplying the operating pressure contained within the table by a system reduction coefficient $k_s = 0.8$ (this value contains installation technical influences such as welding joint, flange, or bending loads.)
2. The operating pressure has to be reduced by the corresponding reducing coefficients for every application.

D

Pressure curve for pipes out of PPH
(acc. to EN ISO 15494, supplement C)

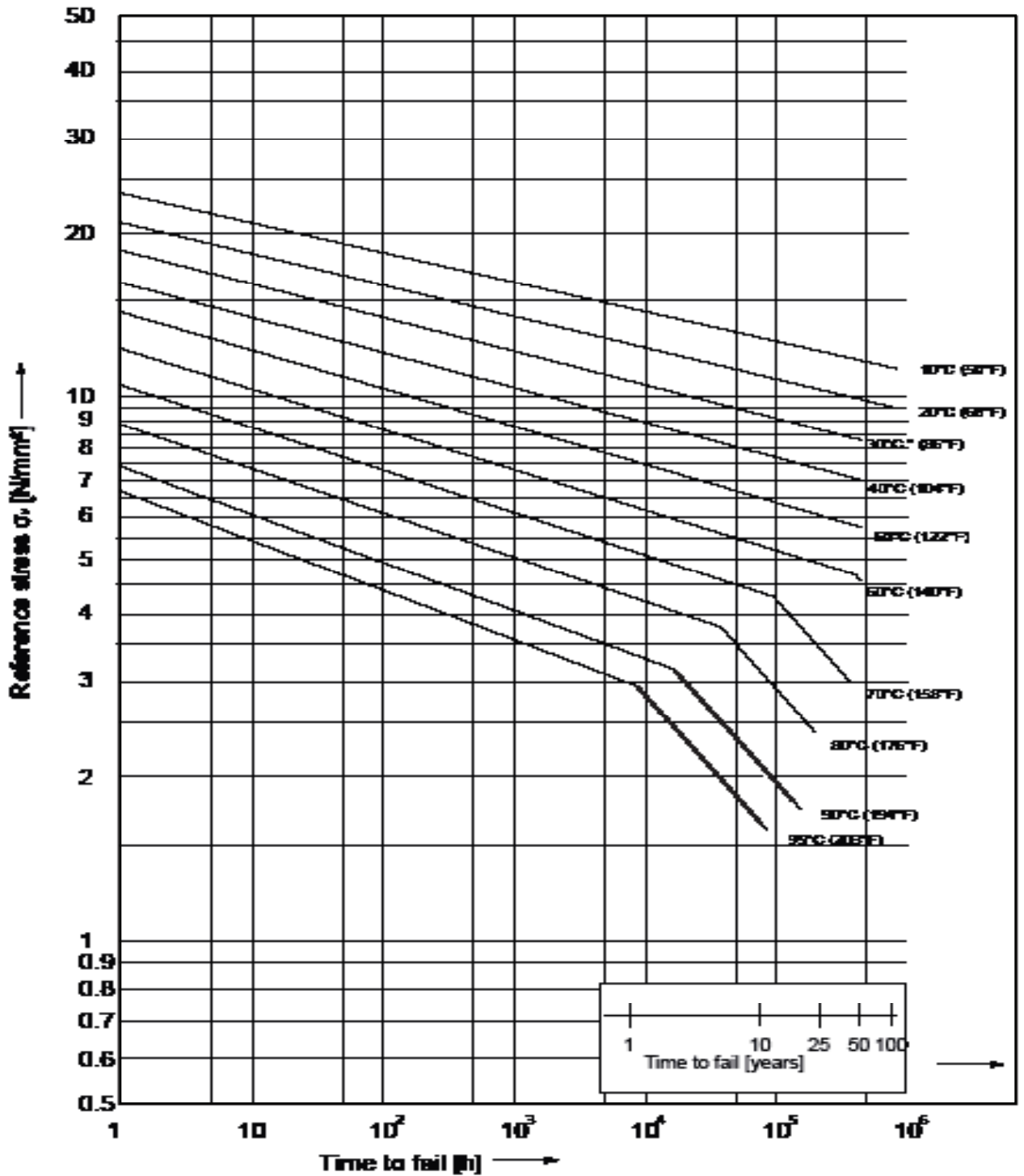

Table D-4. Pressure Curve PPH

Permissible component operating pressures p_B for PPH, depending on temperature and operation period.

In the table below, the data applies to water. They were determined from the creep curve, taking into account a safety coefficient of C (C=1.6 from 10-under 40°C, C=1.4 from 40-under 60°C, C=1.25 from 60°C).

Temperature °F (°C)	Operating period (years)	Diameter-wall thickness relation SDR						
		41	33	26	18	11	7	6
		Pipe series S						
		20	16	12	8	5	3	2
		PN						
		2	3	4	6	10	16	20
permissible component operating pressure psi								
50 (10)	1	65	81	104	138	262	409	525
	3	59	74	96	143	241	376	481
	10	58	72	93	139	232	362	464
	25	55	68	88	132	220	345	441
	50	52	63	84	128	212	332	425
	100	51	64	81	123	204	320	409
68 (20)	1	57	70	90	136	226	354	452
	3	51	64	83	125	206	322	413
	10	49	61	78	119	199	310	397
	25	46	58	75	113	188	294	377
	50	45	57	72	109	181	283	362
	100	43	54	70	104	174	271	348
86 (30)	1	48	59	77	116	193	303	387
	3	43	53	70	106	175	274	351
	10	42	52	67	101	168	262	336
	25	39	49	64	96	159	249	319
	50	38	48	61	91	152	238	306
	100	37	47	60	89	149	234	299
104 (40)	1	46	58	74	113	187	293	376
	3	42	52	67	101	168	264	338
	10	39	49	64	97	161	252	323
	25	38	46	61	91	152	238	304
	50	36	45	58	87	145	228	291
	100	35	44	57	85	142	224	286
122 (50)	1	39	49	67	94	157	246	315
	3	35	43	57	84	141	220	281
	10	33	42	54	80	133	210	268
	25	30	39	49	75	126	197	252
	50	29	38	48	72	120	187	241
	100	28	37	47	70	117	183	236
140 (60)	1	36	45	58	87	146	228	293
	3	32	41	51	78	129	203	260
	10	30	38	49	74	123	193	246
	25	28	35	45	70	115	180	231
	50	26	33	42	64	107	168	216
	100	25	32	41	62	104	164	211
158 (70)	1	29	36	48	71	119	187	239
	3	26	32	42	62	104	164	210
	10	25	30	39	59	100	155	200
	25	20	25	32	49	81	129	164
	50	17	22	28	42	70	109	139
	100	16	21	27	40	68	106	136
176 (80)	1	23	29	38	58	96	151	193
	3	20	25	32	48	80	126	161
	10	16	20	26	41	68	106	136
	25	13	16	22	32	54	84	109
194 (90)	1	19	23	30	45	75	119	152
	3	13	16	22	32	54	86	109
	10	12	14	17	28	45	71	91
203 (95)	1	16	20	26	39	67	104	133
	3	10	13	17	26	45	70	90
	(10) ⁴	9	12	14	22	38	59	75

Table D-5. Permissible Component Operating Pressure PPH

- For calculation of the operating pressure in line installed piping systems, we recommend multiplying the operating pressure contained within the table by a system reduction coefficient $k_s = 0.8$ (this value contains installation technical influences such as welding joint, flange, or bending loads).
- The operating pressure has to be reduced by the corresponding reducing coefficients for every application.
- Operating pressures do not apply to pipes exposed to UV radiation. Within 33 years of operation, this influence may be compensated or essentially reduced by corresponding additives (e.g., carbon black) to the molting material.
- The values in brackets are valid at proof of longer testing periods than 1 year at the 110°C test.

D

Pressure curve for pipes out of PPR
(acc. to EN ISO 15494, supplement C)

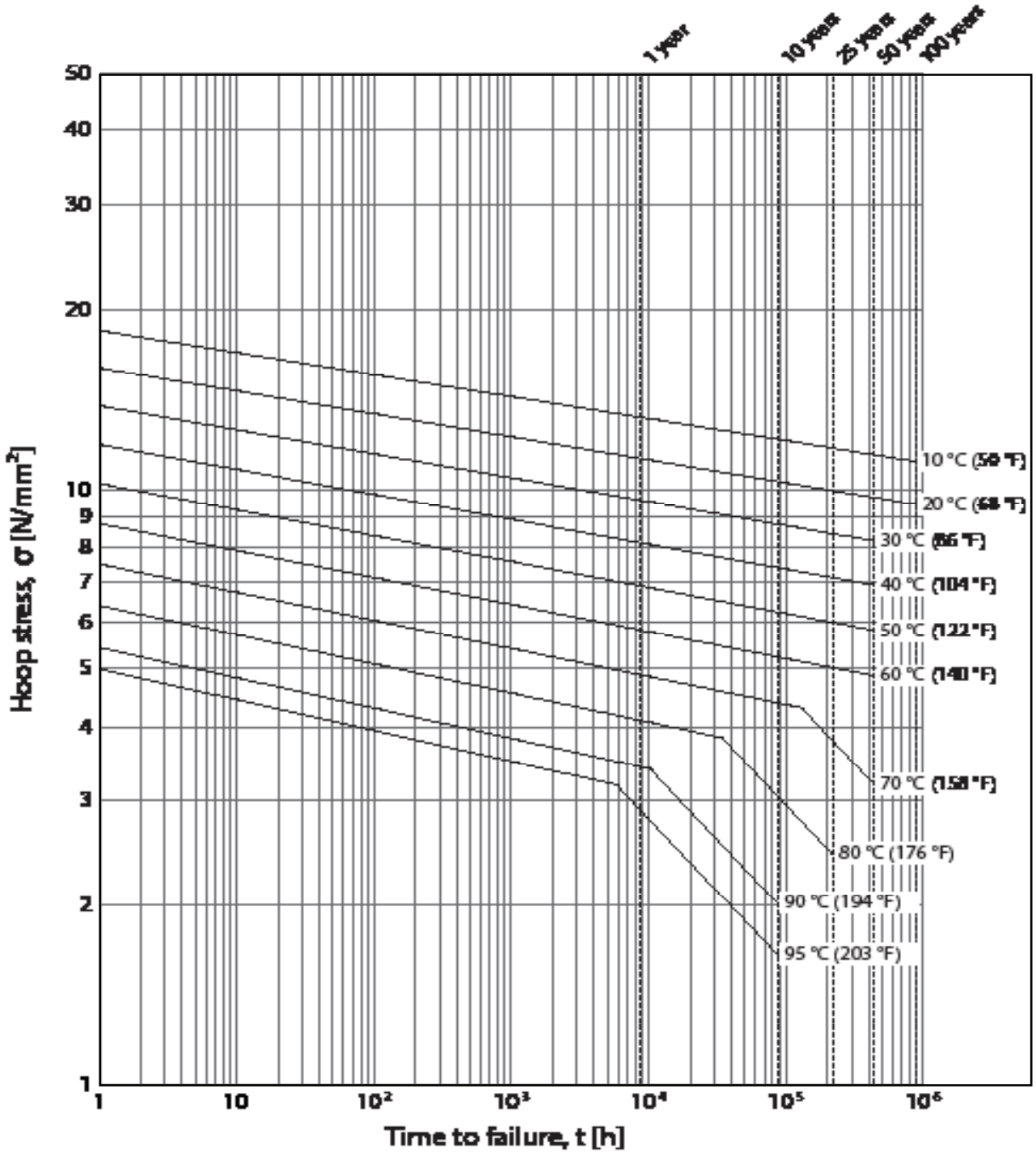

Table D-6. Pressure Curve PPR

Permissible component operating pressures p_B for PPR, depending on temperature and operation period.

In the table below, the data applies to water. They were determined from the creep curve, taking into account a safety coefficient of $C=1.25$. Due to the different mechanical properties of the specific material PP-s-el, the maximum operating pressure has to be reduced to 50 percent.

Temperature °F (°C)	Operating period (years)	Diameter-wall thickness relation SDR												
		41	33	26	17	17	11	7.4	6					
		Pipe series S												
		20	16	12	8	8	5	3	2					
PN														
2								3	4	6	6	10	16	20
permissible component operating pressure (psi)														
30 (10)	1	77	97	122	184	193	306	484	609					
	5	72	91	115	174	181	290	458	577					
	10	71	88	112	168	177	280	444	558					
	25	68	86	107	162	171	271	429	541					
	50	67	84	104	158	167	264	418	526					
68 (20)	1	65	83	104	157	164	261	415	522					
	5	61	78	97	148	154	245	389	490					
	10	59	75	94	144	151	238	378	476					
	25	58	72	93	139	145	232	367	461					
	50	57	71	90	135	141	225	355	448					
86 (30)	1	55	70	88	133	139	222	352	444					
	5	52	65	83	125	130	209	331	416					
	10	51	64	80	122	128	202	319	402					
	25	49	61	77	117	122	194	309	389					
	50	48	59	75	115	119	190	300	383					
104 (40)	1	46	59	74	113	119	187	297	374					
	5	43	55	70	106	110	175	278	351					
	10	43	54	68	103	107	171	271	342					
	25	41	52	65	99	103	164	261	328					
	50	41	51	64	96	100	159	254	319					
133 (50)	1	41	51	64	96	100	159	254	319					
	5	38	46	59	88	93	148	235	296					
	10	36	45	57	87	90	144	228	286					
	25	35	43	55	84	87	139	220	277					
	50	33	42	54	81	84	135	213	268					
140 (60)	1	33	42	54	81	84	135	213	268					
	5	32	39	49	75	78	125	199	249					
	10	30	38	48	72	75	120	191	241					
	25	29	36	46	70	72	116	183	231					
	50	28	35	45	67	71	112	175	222					
158 (70)	1	29	36	45	68	71	113	180	226					
	5	26	33	42	62	65	104	165	207					
	10	26	32	41	61	64	101	161	203					
	25	22	28	35	52	55	88	139	175					
	50	19	23	29	45	46	74	117	148					
176 (80)	1	23	30	38	57	59	94	151	190					
	5	20	26	33	51	52	83	132	167					
	10	17	22	28	42	43	70	110	139					
	25	14	17	22	33	35	55	88	110					
	203 (93)	1	17	22	26	41	42	67	106	133				
5		-	14	17	26	28	43	70	88					
(10) ⁴		-	-	14	22	23	38	58	74					

Table D-7. Permissible Component Operating Pressure PPR

- For calculation of the operating pressure in free installed piping systems, we recommend multiplying the operating pressure contained within the table by a system reduction coefficient $k_s = 0.8$ (this value contains installation technical influences such as welding joint, flange, or bending loads).
- The operating pressure has to be reduced by the corresponding reducing coefficients for every application.
- Operating pressures do not apply to pipes exposed to UV radiation. Within 20 years of operation, this influence may be compensated or essentially reduced by corresponding additives (e.g., carbon black) to the molding material.
- The values in brackets are valid at proof or longer testing periods than 1 year at the 110°C.

D

Pressure curve for pipes out of PVDF
(acc. to EN ISO 10931, supplement A)

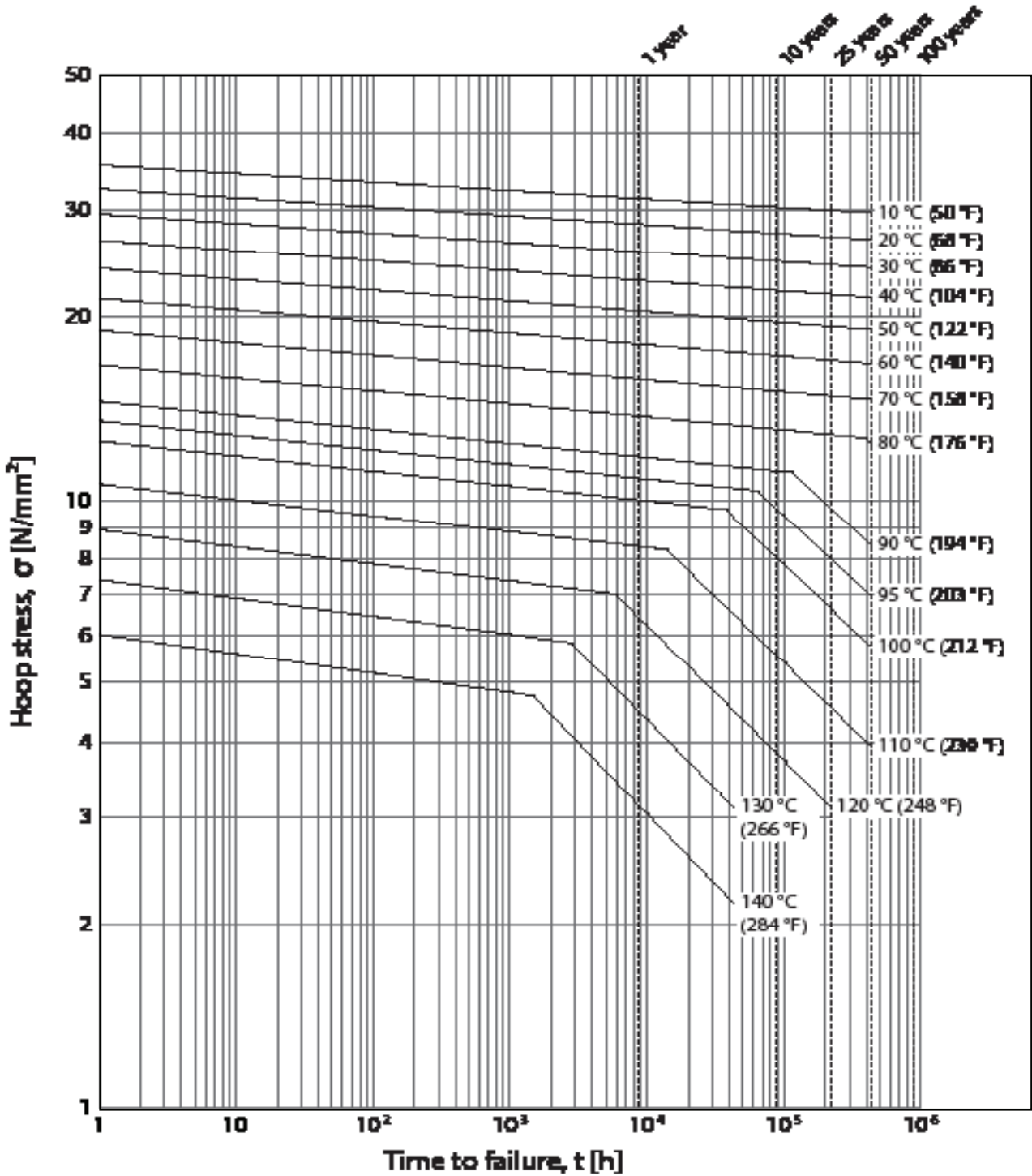

Table D-8. Pressure Curve PVDF

Permissible component operating pressures p_B for PVDF, depending on temperature and operation period.

In the table below, the data applies to water. They were determined from the creep curve, taking into account a safety coefficient of $C=1.6$.

Temperature °F (°C)	Operating period (years)	Diameter-wall thickness relation SDR	
		33	21
		Pipe series S	
		16	10
		PN	
		10	16
Permissible component operating pressure (psi)			
68 (20)	1	167	261
	10	159	251
	25	158	248
	50	157	246
86 (30)	1	148	232
	10	145	229
	25	145	228
	50	141	222
104 (40)	1	133	210
	10	132	207
	25	130	204
	50	128	202
122 (50)	1	120	190
	10	116	183
	25	112	177
	50	110	173
140 (60)	1	107	168
	10	103	161
	25	101	159
	50	100	157
158 (70)	1	96	149
	10	91	144
	25	90	142
	50	88	141
176 (80)	1	81	129
	10	78	122
	25	77	120
	50	75	119
203 (95)	1	64	100
	10	59	93
	25	48	77
	50	42	65
230 (110)	1	46	72
	10	32	51
	25	26	42
	50	23	36
248 (120)	1	36	58
	10	22	35
	25	19	29

Table D-9. Permissible Component Operating Pressure PVDF

1. For calculation of the operating pressure in free installed piping systems, we recommend multiplying the operating pressure contained within the table by a system reduction coefficient $k_s = 0.8$ (this value contains installation technical influences such as welding joint, flange, or bending loads).

2. The operating pressure has to be reduced by the corresponding reducing coefficients for every application.

D

Pressure curve for pipes out of E-CTFE
(acc. to DVS 2205-1, supplement 18)

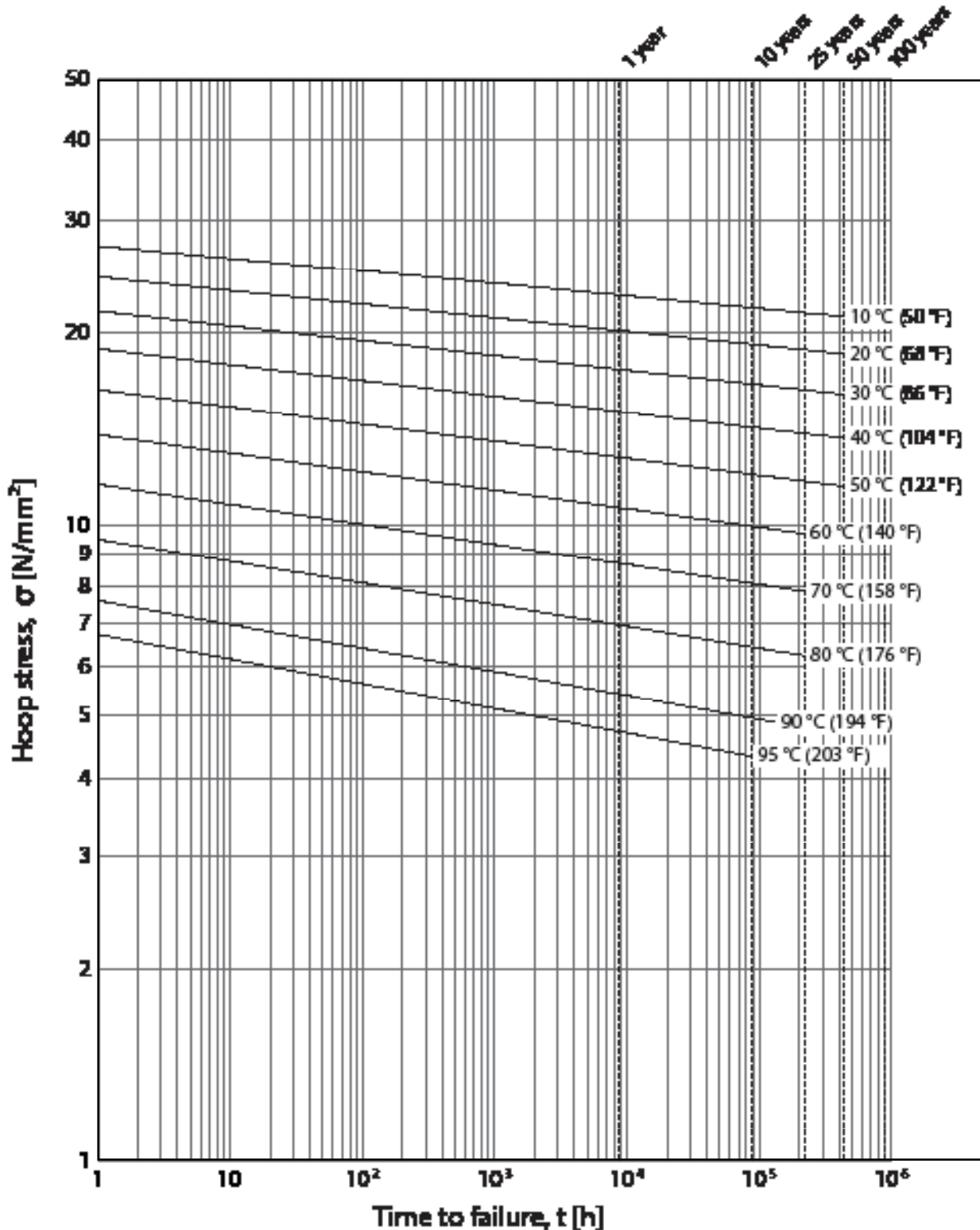

Table D-10. Pressure Curve E-CTFE

Permissible component operating pressures p_B for E-CTFE, depending on temperature and operation period.

In the table below, the data applies to water. They were determined from the creep curve, taking into account a safety coefficient of $C=1.6$.

Temperature °F (°C)	Operating period (years)	Diameter-wall thickness relation SDR	
		33	21
		Pipe series S	
		16	10
Permissible component operating pressure (psi)			
50 (10)	1	129	207
	3	125	200
	10	123	197
	25	122	194
	50	119	191
68 (20)	1	115	183
	3	110	175
	10	107	173
	25	106	170
	50	104	167
86 (30)	1	99	158
	3	96	152
	10	94	152
	25	91	146
	50	90	145
104 (40)	1	84	136
	3	81	130
	10	80	129
	25	78	126
	50	77	123
122 (50)	1	71	115
	3	68	110
	10	67	109
	25	65	106
	50	64	103
140 (60)	1	59	96
	3	57	91
	10	55	90
	25	54	87
	50	53	86
158 (70)	1	48	78
	3	46	74
	10	45	72
	25	43	71
	50	42	70
176 (80)	1	39	62
	3	36	59
	10	36	58
	25	35	55
	50	34	54
194 (90)	1	30	48
	3	28	45
	10	28	45
	25	28	43
	50	27	42
203 (95)	1	26	42
	3	25	39
	10	23	39

Table D-11. Permissible Component Operating Pressure E-CTFE

1. For calculation of the operating pressure in free installed piping systems, we recommend multiplying the operating pressure contained within the table by a system reduction coefficient $k_s = 0.8$ (this value contains installation technical influences such as welding joint, flange, or bending loads).

2. The operating pressure has to be reduced by the corresponding reducing coefficients for every application.

D

Creep modulus curves for PE100 (acc. to DVS 2205, part 1)

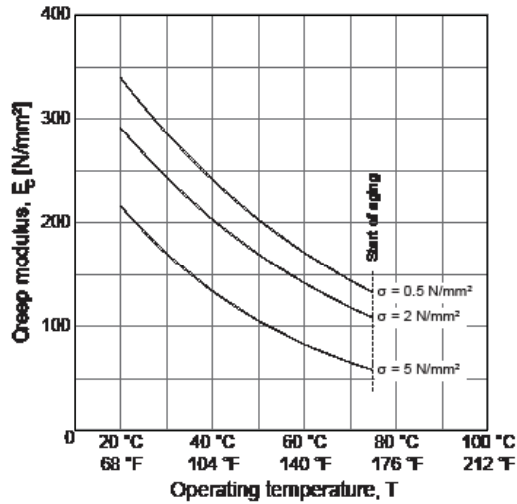

Figure D-1. Creep modulus curve for PE100 at 1 year

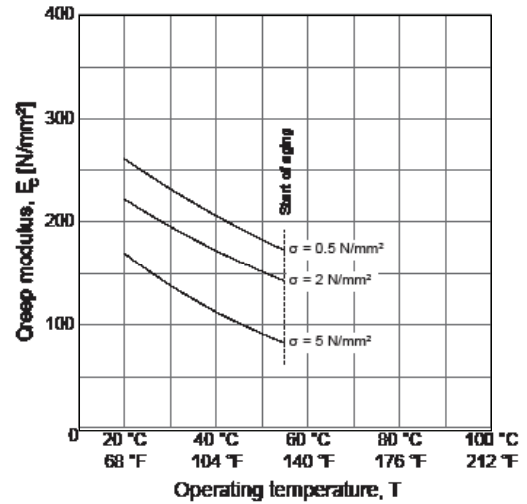

Figure D-2. Creep modulus curve for PE100 at 10 years

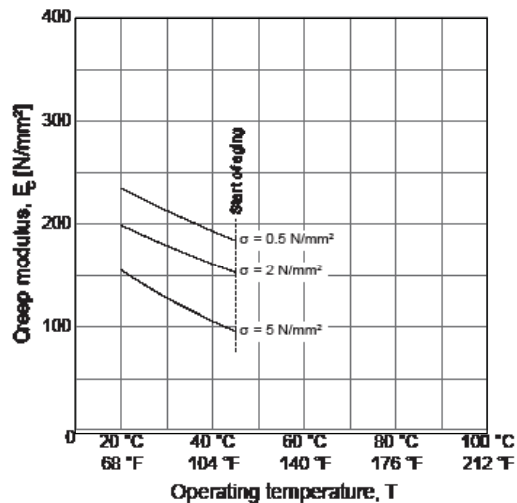

Figure D-3. Creep modulus curve for PE100 at 25 years

Reducing the creep modulus

In the above diagrams, the calculated creep modulus still has to be reduced by a safety coefficient of ≥ 2 for stability calculations.

Influences by chemical attack or by eccentricity and unroundness must be taken into account separately.

Creep modulus curves for PPH
(acc. to DVS 2205, part 1)

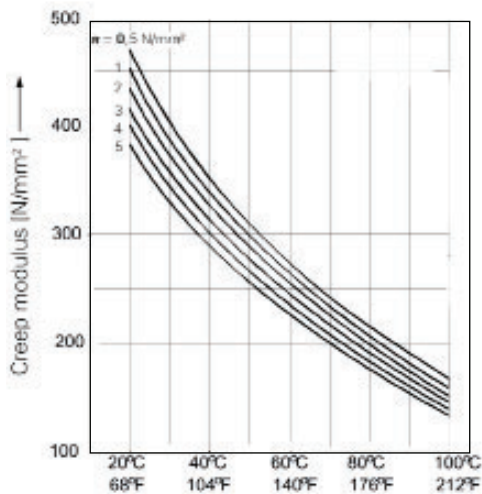

Figure D-4. Creep modulus curve for PPH at 1 year

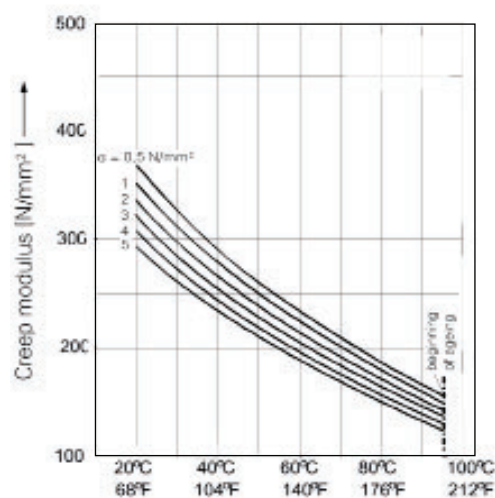

Figure D-5. Creep modulus curve for PPH at 10 years

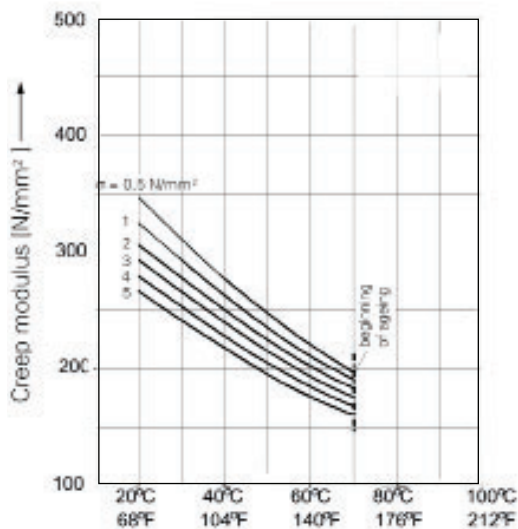

Figure D-6. Creep modulus curve for PPH at 25 years

Reducing the creep modulus

In the above diagrams, the calculated creep modulus still has to be reduced by a safety coefficient of ≥ 2 for stability calculations.

Influences by chemical attack or by eccentricity and unroundness must be taken into account separately.

Creep modulus curves for PPR/PPB (acc. to DVS 2205, part 1)

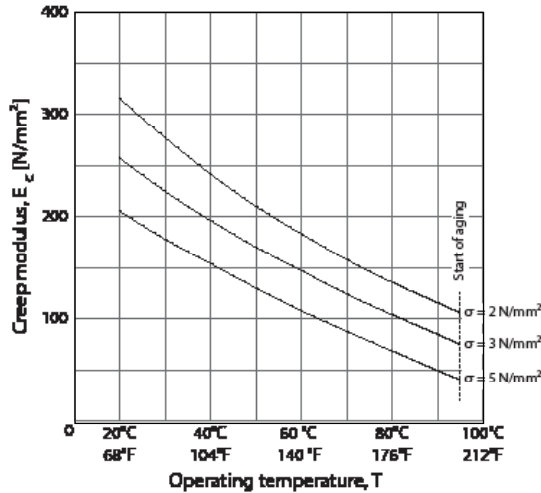

Figure D-7. Creep modulus curve for PPR/PPB at 1 year

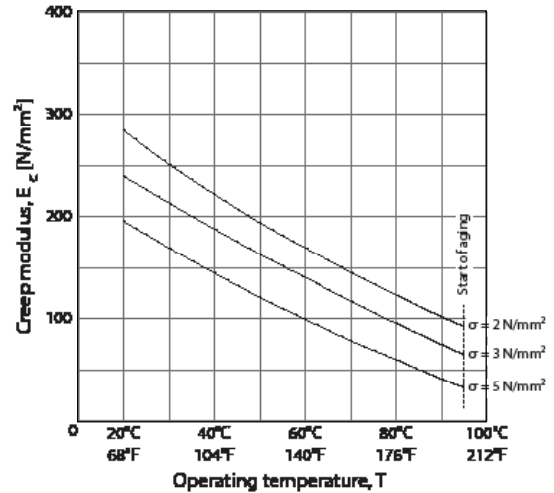

Figure D-8. Creep modulus curve for PPR/PPB at 10 years

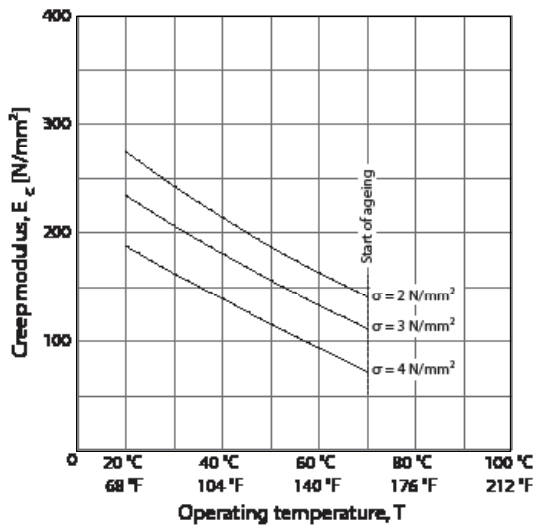

Figure D-9. Creep modulus curve for PPR/PPB at 25 years

Reducing the creep modulus

In the above diagrams, the calculated creep modulus still has to be reduced by a safety coefficient of ≥ 2 for stability calculations.

Influences by chemical attack or by eccentricity and unroundness must be taken into account separately.

Creep modulus curves for PVDF
(acc. to DVS 2205, part 1)

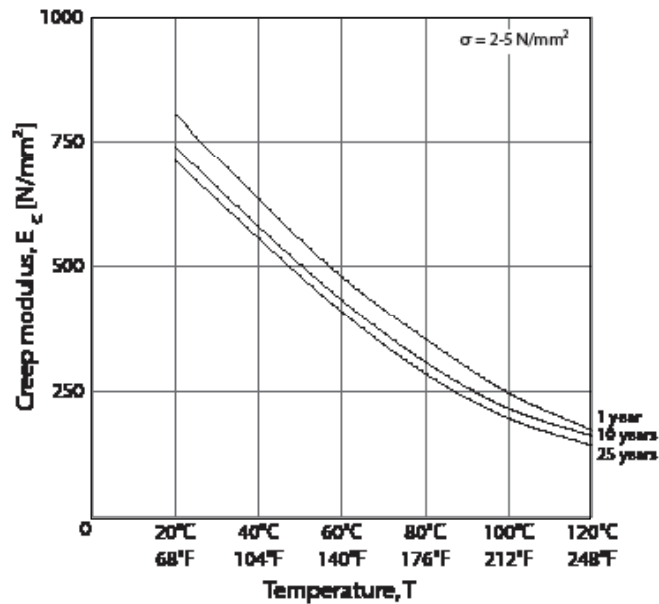

Figure D-10. Creep modulus curves for PVDF at 1, 10, and 25 years

Reducing the creep modulus

In the above diagrams, the calculated creep modulus still has to be reduced by a safety coefficient of ≥ 2 for stability calculations.

Influences by chemical attack or by eccentricity and unroundness must be taken into account separately.

D

Creep modulus curves for E-CTFE
(acc. to DVS 2205, part 1)

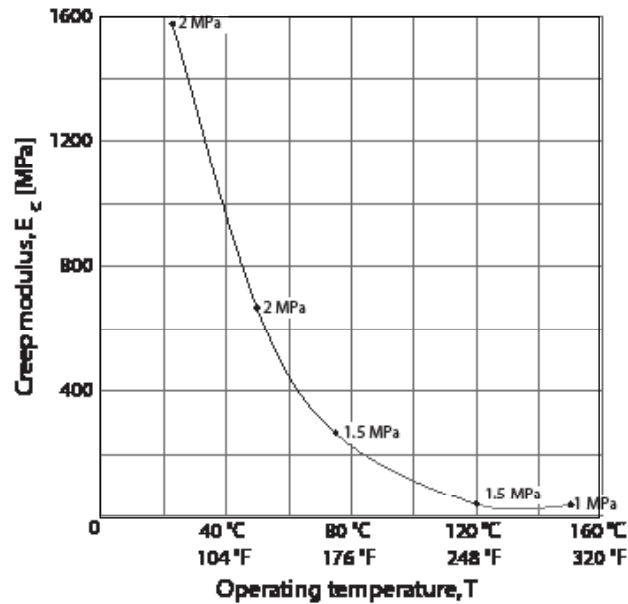

Figure D-11. Creep modulus curves for E-CTFE

Reducing the creep modulus

In the above diagrams, the calculated creep modulus still has to be reduced by a safety coefficient of ≥ 2 for stability calculations.

Influences by chemical attack or by eccentricity and unroundness must be taken into account separately.

VACUUM PRESSURE CHARTS

Permissible vacuum pressures for PE100, PPH and PPR, PVDF, Ventilation Pipes - our of PPH and PE, PVDF - vent

Please see product specifications on www.asahi-america.com

ABRASION RESISTANCE

Behavior with Abrasive Fluids

In principle, thermoplastic pipes are better suited for the conveying of fluid-solid mixtures than, for instance, concrete pipes or steel pipes. We have already had positive experiences for different applications.

In the Technische Hochschule Darmstadt developed method, a 1 m long half-pipe is tilted with a frequency of 0.18 Hz. The local deduction of the wall thickness after a certain loading time is regarded as a measure of the abrasion.

The advantage of thermoplastic pipes for the transportation of solids in open channels can clearly be seen from the test result.

Medium: silica sand-gravel-water mixture
Silica-gravel 46% volume, grain size up to 30 mm

For conveying of dry, abrasive-acting fluids, polypropylene can only be applied conditionally. Only electroconductive materials should be used (i.e., PE-el, PPR-s-el, PPR-el) due to a possible static load.

The use of each single application has to be clarified with our technical engineering department.

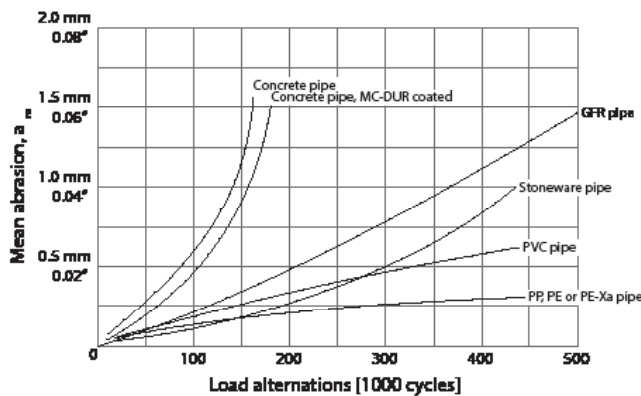

Figure D-12. Abrasion behavior according to Darmstadt method

In a more practical test, the medium is pumped through pipe samples which are built into a piping system. One reason to check the abrasion behavior of such a system is to determine the amount of time until the formation of a hole. As can be seen from the above diagram, thermoplastic pipes (in this case, PE pipes have been applied; PP pipes will achieve the same or slightly better results) have an essential advantage compared to steel pipes.

GENERAL CHEMICAL RESISTANCE

General Chemical Properties of PE & PP

In comparison to metals, where an attack of chemicals leads to an irreversible chemical change in the material, it's largely physical processes of plastics which reduce their utility value. Such physical changes include swelling and solution processes, which can change the composition of the plastics, thereby affecting their mechanical properties. Reducing factors have to be taken into consideration in the design of facilities and selection of parts in these cases.

PE and PP are resistant against diluted solutions of salts, acids, and alkalis if these are not strong oxidizing agents. Good resistance is also given against many solvents, including alcohols, esters, and ketones.

When contact is made with aliphatic and aromatic compounds, such as chlorinated hydrocarbon, a strong swelling will occur, especially at high temperatures; however, destruction is rare.

The resistance can be strongly reduced by stress cracking corrosion due to ampholytics such as chromic acid or concentrated sulfuric acid.

Lyes

Alkalis

Diluted alkali solutions, such as caustic lye, do not react with PP and PE, even at higher temperatures and with higher concentrations, and can, therefore, be applied without problems. This is not the case for PVDF or other fluoroplastics.

Bleaching lye

As these lyes contain active chlorine, only a conditional resistance is given at room temperature.

At higher temperatures and concentrations of the active chlorine, PP and PE are only suitable for pressureless piping systems and tanks.

Hydrocarbons

PP is only conditionally resistant against hydrocarbons (benzine, as well as other fuels) already at ambient temperature (swelling > 3%). PE, however, can be used for the conveying of this media up to temperatures of 104°F (40°C) and for the storage of these media up to temperatures of 140°F (60°C). Only at temperatures

> 140°F (60°C) is PE conditionally resistant, as the swelling is > 3%.

Acids

Sulfuric acid

Concentrations up to approximately 70 percent change the properties of PP and PE only slightly. Concentrations higher than 80 percent cause at-room temperature oxidation. At higher temperatures, this oxidation can result in carbonization of the surface of the PP semi-finished products.

Hydrochloric acid, hydrofluoric acid

Against concentrated hydrochloric acid and hydrofluoric acid, PP and PE are chemically resistant. In PP, however, there is a diffusion of HCl (at concentrations > 20%) and of HF (at concentrations > 40%), which does not damage the material but causes secondary damages to the surrounding steel constructions. Double containment piping systems have proven successful for such applications.

Nitric acid

At higher concentrations, nitric acid has an oxidizing effect on the materials. Additionally, the mechanical strength properties are reduced at higher concentrations.

Phosphoric acid

Against this medium, PP and PE are resistant at higher concentrations and at raised temperatures.

For more detailed information regarding the chemical resistance of our products, our application engineering department will be at your disposal at any time.

Actual lists of chemical properties are available at www.asahi-america.com

Chemical Resistance PVDF

PVDF is resistant to a wide range of chemicals.

It has an outstanding resistance to most organic and inorganic acids, oxidizing media, aliphatic and aromatic hydrocarbons, alcohols, and halogenated solvents.

PVDF is also resistant to halogens (i.e., chlorine, bromine, and iodine), but is not resistant to fluorine.

Generally, PVDF is unsuitable for the following media, because they can lead to decomposition:

- Amine, basic media with an index of $\text{pH} \geq 12$
- Joints, which can produce free radicals under certain circumstances
- Smoking sulfuric acid
- High polar solvents (acetone, ethyl acetate, dimethylformamide, dimethylsulfoxide, etc.); here, PVDF can solve or swell
- Melted alkaline metals or amalgam

Please note that there is a possibility of tension crack development (stress cracking). This can happen when PVDF is situated in a milieu with a pH factor ≥ 12 , or is in the presence of free radicals (for example, elemental chlorine) and it is exposed to mechanical use at the same time.

Example: sulfuric acid

PVDF is exposed to an attack of concentrated sulfuric acid. Through free SO_3 in the sulfuric acid, tension crack development (stress cracking) can happen if it is also exposed to a mechanical use. In high temperatures, the concentration of free SO_3 , even in strongly diluted sulfuric acid solution, can lead to tension crack development.

To determine the permissible pressure with the presence of sulfuric acid, and taking into account temperature, we have analyzed the behavior of PVDF pipes at various pressures and temperatures in the DECHEMA-bracket (see graph below).

The following essential parameters should be considered in every case:

Properties of the finished piece of PVDF

- Chemical structure and physical state of the joint(s) which come into contact with the PVDF fitting
- Concentration
- Temperature
- Time
- Possible diffusion or solubility

Actual lists of chemical properties are available at www.asahi-america.com

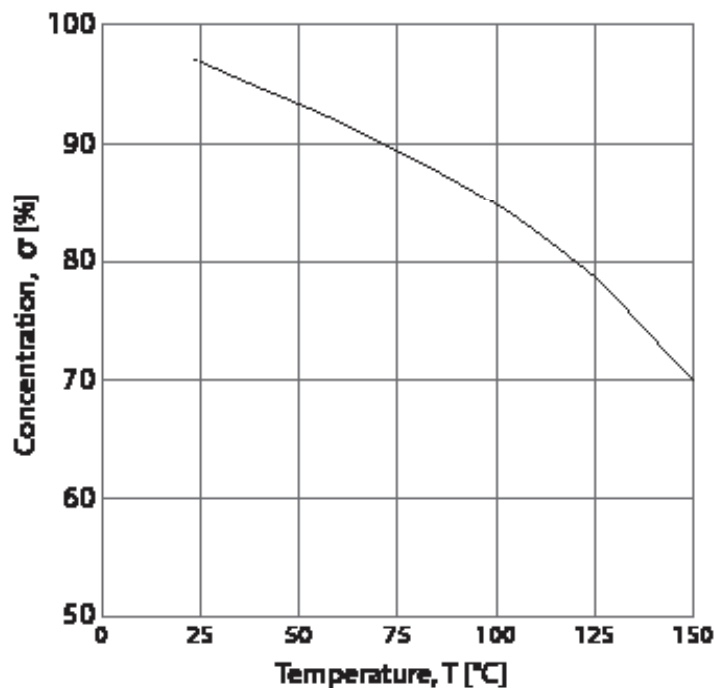

Figure D-13. Maximum permissible H_2SO_4 concentration for PVDF pipes, depending on temperature (based on tests with the Dechema Console).

Chemical Resistance E-CTFE

E-CTFE has an outstanding chemical resistance and a remarkable barrier property. It resists attack from most industrial-used corrodible chemicals, including strong mineral and oxidized acids, alkaline, metal-etching products, liquid oxygen, and all organic solvents, except hot amines (e.g., aniline, dimethylamine).

Undiluted solvents were used in the testing of the constancy data for solvents in the following table. A chemical attack depends on the concentration; therefore, for a lower concentration of the listed media, a smaller effect than is shown in the table would be expected.

Like other fluorine plastics, E-CTFE will be attacked by sodium and potassium. The attack depends on the induction period and the temperature. E-CTFE and other fluorine polymers can be in contact with special halogenated solvents; this effect typically has no influence on the usability. If the solvent is taken away and the surface is dried, the mechanical properties come back to their origin values, which shows that no chemical attack has taken place.

Actual lists of chemical properties are available at www.asahi-america.com

Chemical	Temperature (°C)	Temperature (°F)	Weight gain (%)	Influence on tensile modulus	Influence on elongation at break
Mineral acid					
Sulfuric acid 78%	23	73.4	< 0.1	N	N
	121	249.8	< 0.1	N	N
Hydrochloric acid 37%	23	73.4	< 0.1	N	N
	75-105	167-221	0.1	N	N
Hydrochloric acid 60%	23	73.4	< 0.1	N	N
Chlorosulfonic acid 60%	23	73.4	0.1	N	N
Oxidizing acid					
Nitric acid 70%	23	73.4	< 0.1	N	N
	121	249.8	0.8	A	C
Chromic acid 50%	23	73.4	< 0.1	N	N
	111	231.8	0.4	N	N
Aqua regia	23	73.4	0.1	N	N
	75-105	167-221	0.5	N	N
Solvents					
Aliphates					
Hexane	23	73.4	0.1	N	N
	54	129.2	1.4	A	N
Isooctane	23	73.4	< 0.1	N	N
	116	240.8	3.3	A	N
Aromates					
Benzene	23	73.4	0.6	N	N
	74	165.2	7.0	C	N
Toluene	23	73.4	0.6	N	N
	110	230	8.5	C	N
Alcohols					
Methanol	23	73.4	0.1	N	N
	60	140	0.4	A	N
Butanol	23	73.4	< 0.1	N	N
	118	244.4	2.0	A	N
Classical plastic solvents					
Dimethyl formamide	73	163.4	2.0	A	N
	250	482	7.5	C	N
Dimethyl sulfoxide	73	163.4	0.1	N	N
	250	482	3.0	N	N

Table D-17. Chemical Resistance E-CTFE

N = No Change
 A = Reduction by 25-50%
 B = Reduction by 50-75%
 C = Reduction by > 75%

SURFACE ROUGHNESS

Surface roughness can have a significant influence upon the quality of the conveyed media.

The smooth surface of AGRU UHP components is achieved by applying specially designed and designated manufacturing equipment and tooling. The use of mirror-finished tools made of special material for injection molding and extrusion has a significant influence upon the surface quality of final products. AGRU constantly monitors the surface quality during production of UHP components, whereby the surface roughness (R_a values) and micropores are measured. These tests, which are performed on a statistical basis, provide an excellent indication of the quality of the manufacturing process.

The surface quality has been significantly improved for the Purad® material grade.

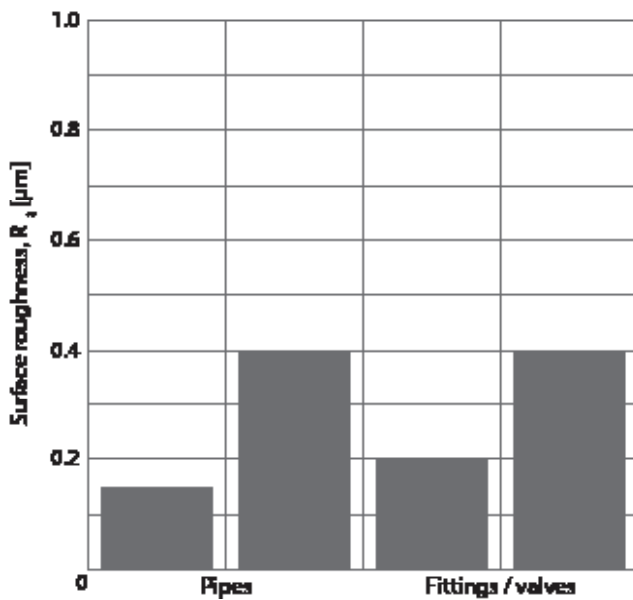

OD 20-225mm OD 250mm OD 20-225mm OD 250mm
 OD 1/2" - 9" OD 10" OD 1/2" - 9" OD 10"

Figure D-14. Surface specification for Purad® pipes

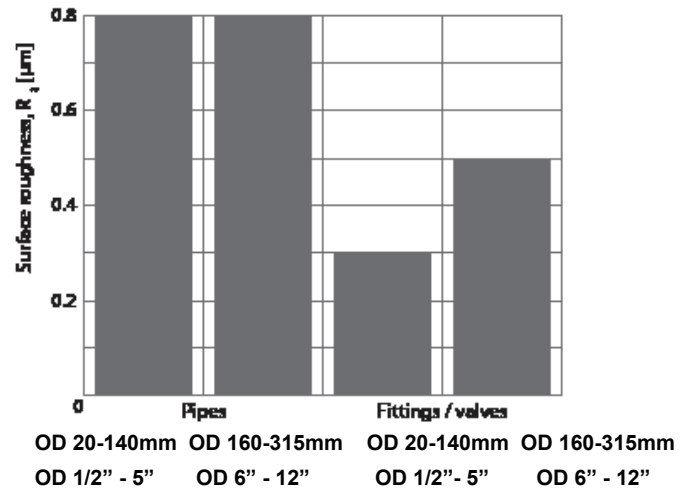

Figure D-15. Surface specification for PP-Pure® pipes

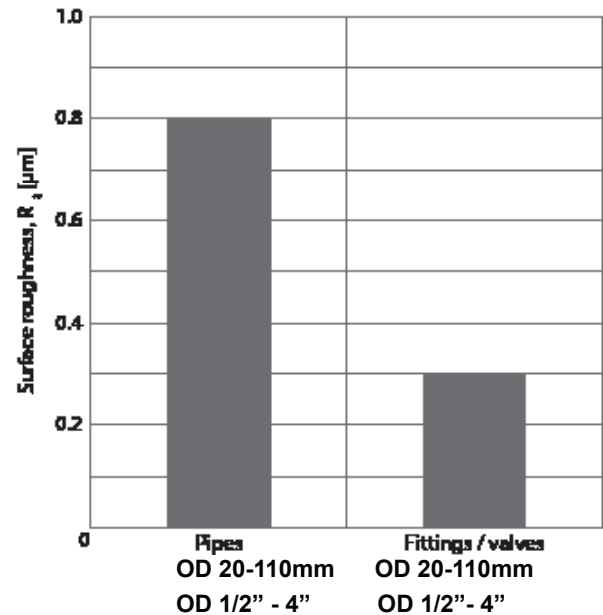

Figure D-16. Surface specification for PolyPure® pipes

In addition this consistent control, surface analyses in accordance with SEMATECH 92010952B-STD and interferential microscopy are performed by Jenoptik L.O.S. GmbH Germany.

	Purad® OD 63 (2") SDR21	PP-Pure® OD 63 (2") SDR11
Surface Analysis		
Zmax (nm)	818	1134
RMS (nm)	100	183
Ra (nm)	79	79
SA-Index	17	22

Table D-18. Surface roughness values

PRODUCTION AND PACKAGING

Pipe Production

Purad® (UHP PVDF)

Asahi’s Purad® UHP PVDF piping is produced from ultrapure virgin PVDF raw material. The dimensionals range from 20mm to 315mm (1/2” to 12”) are manufactured in a cleanroom class ISO 5, on dedicated extrusion equipment. Pressure range: SDR21 and SDR33. The extrusion lines are specially equipped and adapted for the production of UHP components in a cleanroom area.

PolyPure® (PPn) and PP-Pure® (PPp)

Asahi’s PP-Pure® and PolyPure® pipes are made out of virgin PP-R raw material on specifically designated production lines. The manufacturing for the dimensionals range 20mm to 315mm (1/2” to 12”) in SDR11 is performed under cleanroom environment, whereby a laminar flow box class ISO 6 is integrated in the production line.

Ultra Proline® (E-CTFE)

Asahi’s Ultra Proline® E-CTFE pipes are produced from virgin E-CTFE raw material. The pipes are available in two pressure classes. The pressure pipes SDR21 from 20mm to 110mm (1/2” to 4”) and the ventilation pipes are available in the dimensions 110mm and 160mm (4” and 6”).

Fitting and Valve Production

Fitting and valve production techniques and facilities are dependent on the materials to be molded. Purad® and Ultra Proline® fittings and valves are produced on dedicated molding machines using virgin material in a cleanroom class ISO 5 environment. The material-specific molds are utilized to provide the required surface quality.

PP-Pure® and PolyPure® fittings and valves are manufactured out of PP-R raw material in a clean environment on designated molding equipment.

Machining of injection molded components is necessary to remove sprues and finish the sealing surfaces on items such as unions or stub ends.

After machining, all Purad® fittings and valves are cleaned. The cleaning process is performed in a cleanroom class ISO 5 environment. The process is fully

automated.

In the cleaning facility, the fittings and valves are rinsed for a minimum of 60 minutes with UPW (quality: TOC <10 ppb, conductivity >18 MOhm at an elevated temperature > 158°F (70°C)). After drying with hot clean-air and a 100 percent inspection, the valves are assembled and all fittings and valves are double packed under a cleanroom environment class ISO 5.



Figure D-17. Pipe production

Packaging

Packaging of pipes

All Purad® pipes are immediately packaged after production in a cleanroom environment class ISO 5. Pipes are sealed on both ends with a PE film and closed with PE caps. The pipe is then sleeved into a PE bag and heat sealed on both ends. Finally, the packed pipes are put into rigid PE tubes, which are non-particle generating and resistant to moisture and impacts of transport and shipment.

PP-Pure® pipes are packaged immediately after production under laminar flow box class ISO 5 environment. The pipe ends are capped, sleeved into a transparent PE bag, and heat sealed on both ends. Additionally, the pipes are sleeved in a second PE bag (double packaging), and the bag is heat sealed again on both sides.

PolyPure® pipes are packaged immediately after production under laminar flow box class ISO 5 environment. The pipe ends are capped and sleeved into a transparent PE bag and heat sealed on both ends.

Ultra Proline® pipes are packaged in a clean environment immediately after production. The pipe ends are capped and sleeved in transparent PE bags and heat sealed on both sides. The dimensions, 110mm (4”) or bigger, are put into a rigid PE protection tube.

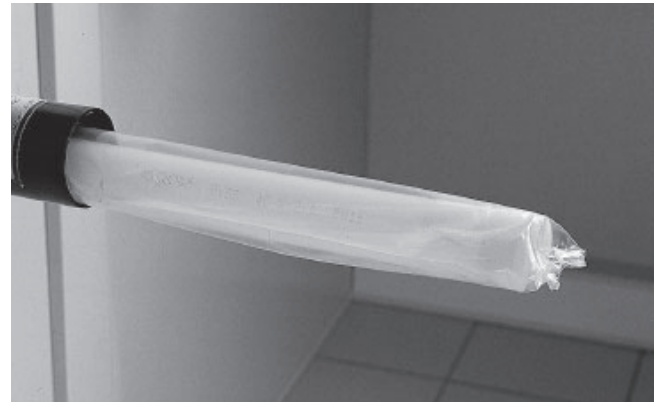

Figure D-18. Pipe packaging

Packaging of fittings/valves

Purad®: After production, machining, 100 percent inspection, and cleaning/rinsing with UPW water, all fittings/valves are packed in a class ISO 5 cleanroom area. Fittings are double packed in PE composite bags. The first bag is purged with nitrogen. Bags are silicone free and anti-static. Finally, the packed fittings are put in cardboard boxes for transport.

PP-Pure®: After production and machining of the injection gates, the fittings/valves are 100 percent inspected and cleaned/rinsed with UPW water. In a class ISO 5 cleanroom area, all fittings and valves are purged with nitrogen and double bagged in PE composite bags. Bags are silicon free and anti-static.

PolyPure®: After production and machining of the injection gates, the fittings/valves are 100 percent inspected and cleaned/rinsed with UPW water. In a class ISO 5 cleanroom area, all fittings and valves are single packed in PE composite bags. Bags are silicon free and anti-static.

The Purad®, PolyPure® and PP-Pure® valves are cleaned and assembled in a cleanroom class ISO 5 environment as well. To guarantee a 100 percent leakproof valve, they will be assembled according to the internal procedures and torque values and kept in the cleanroom for a minimum of 24 hours. The valves will be checked again, the bonnet bolts will be retorqued, and then they will finally be double packaged and put in cardboard boxes for transport.

Ultra Proline® E-CTFE fittings and valves are single packed in PE bags only. Fittings and valves are then put in cardboard boxes for transport purposes.

Dimension		Quantity
(mm)	(inch)	
20	1/2	5
25	3/4	4
32	1	3
40-315	1-1/4 - 12	1

Table D-19. Packaging units for PP-Pure® and PolyPure®

Marking

All Purad® High Purity components are marked according to ISO 10931. Furthermore, the quality classification is noted. Protection tubes for high purity pipes and cardboard boxes for high purity fittings and valves are also marked with labels containing the appropriate information.

High Purity PVDF Resin Production

Purad® is exclusively produced from Solvay Solef 1000 Series high purity resin. Solef 1000 series resins use a suspension production process according to ASTM D 3222, Type II PVDF UHP resin.

The suspension process, as opposed to emulsion or Type I PVDF, allows the manufacture of polymers with fewer structural defects in the molecular chain. In other words, the Purad® polymers are more crystalline. Thus, the melting temperature and the mechanical characteristics are higher than homopolymers with the same average molecular weights obtained by emulsion polymerization.

The Purad® raw material is packed in specially chosen packaging material and shipped to AGRU.

The virgin Purad® raw material is manufactured under clean conditions on specially designated equipment. Pelletizing and packaging of the materials are performed under controlled air quality. The raw material provider is regularly audited and certified Acc. ISO 9001 as well as ISO 14001.

The importance of exclusively using Solef PVDF ultra high purity resin is three-fold:

- It provides a consistently clean, mechanically superior system
- It provides superior welding/joining capabilities as nature and melt flow indices of all components are as close as possible
- Identical color index



Figure D-20.



Figure D-21. Fitting packaging



Figure D-22. Fitting production

STORAGE AND TRANSPORTATION

Transport and Handling

At the transport and handling of pipes and fittings, the following guidelines have to be observed in order to avoid damages:

- Transport and support pipes on the full length; that means do not bend or deform them. Take pipes/ fittings carefully from the transport vehicle. Do not throw items.
- Protect from damage through nails, rivets, etc. that may occur on the loading area.
- Impact and bending stresses at temperatures < 32°F (0°C) have to be avoided.
- Damages to the surface (scratches, marks, etc.), will occur from the dragging of pipes. This must be avoided.

Storage

At the storage of pipes and fittings, the following regulations have to be observed in order to avoid any quality decrease:

- The storage area has to be even and free from waste, stones, screws, nails, moisture, and any other conditions that may damage the pipe/fitting/ valve.
- For the piling of pipes, storage heights of 1m (3 ft) may not be exceeded. In order to avoid the pipes rolling away, wooden wedges have to be situated at the outside pipes. Smaller and lighter pipes should be stored on top of bigger sizes.
- Pipes have to be stored flat, without bending stress, and in a wooden frame if possible. Pipes should be stored inside the protection tube and capped.
- Natural and grey colored products have to be protected against UV radiation at outdoor storage areas. In general, Asahi does not recommend storing Purad® products in outdoor areas.
- Cardboard boxes from fittings and/or valves should be removed prior to processing only.
- Used pipes should be cleaned and completely packed under a clean room condition before taking them to stock for further usage.

- Waste disposal of protection tube, cardboard boxes, and protection foil must be done in a proper manner and/or according to national guidelines.

Additionally, the special types of PPR-s-ep and PE-el suffer the danger of absorption of humidity at a storage period above 12 months. It is recommended to check the usability of the material by means of a welding test.



INSTALLATION

General Installation Guidelines

Due to the lower stiffness and rigidity as well as the potential length expansions (caused by changes in temperature) of thermoplastics in comparison with metallic materials, the requirements for the fixing of piping elements should be met.

Onlaying of pipes above ground expansion and contractions of pipes in both radial and axial directions must not be hindered; this means installation with radial clearance, position of compensation facilities, and control of changes in length by reasonable arrangement of fixed points.

Attachments have to be calculated to avoid pinpoint stresses, meaning the bearing areas have to be as wide as possible and adapted to the outside diameter if possible, the enclosing angle has to be chosen $> 90^\circ$.

The surface qualities of the attachments should help to avoid mechanical damage to the pipe surface.

Valves, and, in certain cases, tees, should essentially be installed on a piping system as fixed points. Valve constructions with the attachment devices integrated within the valve body are most advantageous.

Installation by Means of Pipe Clips

Attachments made of either steel or thermoplastics are available for plastic pipes. Steel clips have to be lined with tapes made of PE or elastomers, otherwise the surface of the plastics pipe may be damaged. AGRU plastics pipe clips as well as pipe holders are suitable for installation. These may be commonly applied and have especially been adjusted to the tolerances of the plastics pipes.

Therefore, they serve as sliding bearing at horizontally installed piping systems in order to take up vertical stresses. A further application range of the AGRU pipe clip is the function as guiding bearing which should hinder a lateral buckling of the piping system as it can also absorb transversal stresses.

It is recommended, for smaller pipe diameters ($< OD63mm$), to use steel half-rounded pipes as support of the piping system in order to enlarge the support distances.

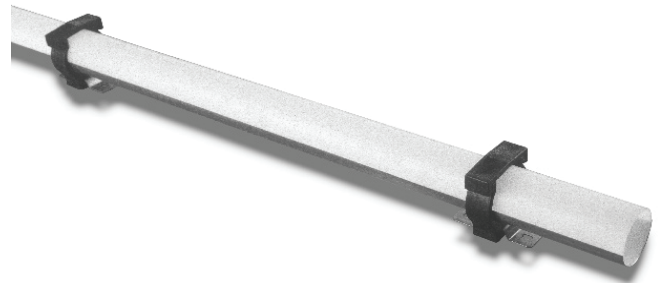

Figure D-23. Pipe support with steel half shell

Pipe sizes OD63-315mm should be supported by means of pipe clips, which do not fix the pipe in an axial direction.



Figure D-24. Pipe clip support

For fixed points (anchors) in the piping system, restraint fittings should be utilized together with suitable pipe clips.

The restrained fittings will prevent movement in the axial direction, but will provide the required flexibility in the radial direction and provide a stress-free application.

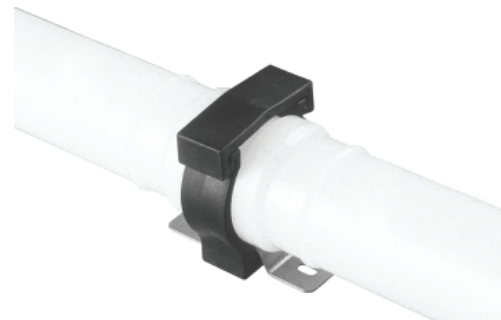

Figure D-25. Anchor and restraint fitting support

Hanger Types

When selecting hangers for a system, it is important to avoid using a hanger that will place a pinpoint load on

D

the pipe when tightened. For example, a U-bolt hanger is not recommended for thermoplastic piping.

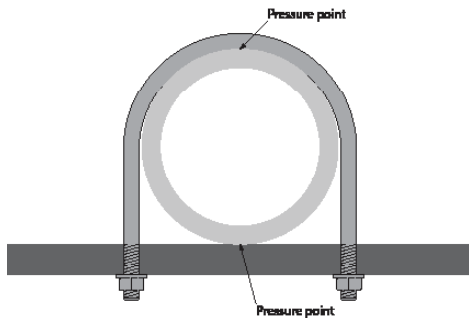

Figure D-26. Effects of U-bolt on pipe

Hangers that secure the pipe 360° around the pipe are preferred. Thermoplastic clamps are also recommended over metal clamps, as they are less likely to scratch the pipe in the event of movement. If metal clamps are specified for the project, they should be inspected for rough edges that could damage the pipe. Ideally, if a metal clamp is being used, an elastomeric material should be used in between the pipe and the clamp. This is a must for PVDF and E-CTFE systems, which are less tolerant to scratching. The figure below illustrates a recommended hanger type.

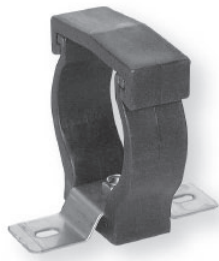

Figure D-27. Recommended clamp

GENERAL INSTALLATION PRACTICES

Contents

Bending	E-2
Socket	E-2
Butt/IR.....	E-5
Electrofusion	E-14
Hot Air	E-15
Extrusion	E-18
Mechanical Connections	E-20

BENDING

Pipe Bending

Many thermoplastic piping systems can be bent to reduce the usage of fittings. Pipe bending procedures are dependent on the intended radius, material, and size and wall thickness of the pipe. Consult with Asahi/America for procedural recommendations.

Polypropylene and HDPE can be bent in the field, but bending PVDF is not recommended.

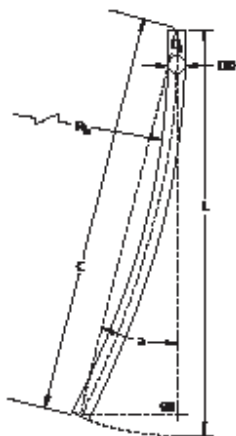

Figure E-1. Asahi/America pipe allowable bend

SOCKET

Socket Fusion

In socket welding, the pipe end and socket fittings are heated to welding temperature by means of a socket and spigot heater inserts. Socket welding may be manually performed on pipe diameters up to 2" (63 mm). Sizes above that require a bench socket tool due to the required joining forces. In sizes greater than 1", a bench style machine may be preferred for ease of operation.

Welding Temperature

The recommended welding temperature for PPH, PPR, PE-HD, and PVDF is between 482°F and 518°F (250°C and 270°C).

Welding Parameters

Table E-1 below can be used as a reference when socket welding PP and PE-HD pipes and fittings at an outside temperature of about 68°F (20°C) with low air-speed rates.

Pipe Size (inches)	A Heat Soak Time (sec)	B Adjusting Time (sec)	C Cooling Time (min)
1/2	5	4	2
3/4	7	4	2
1	8	6	4
1-1/4	12	6	4
1-1/2	18	6	4
2	24	8	6
2-1/2	30	8	6
3	40	8	6
4	50	10	8

Table E-1. Welding Parameters

**Welding Process
Hand-Held Socket Fusion**

Once the heating element is warmed to the proper temperature, welding proceeds as follows:

1. Follow the welding parameters provided with Asahi/America’s socket welding equipment.
2. Follow these steps:
 - a. Cut the pipe faces at right angles, and remove burrs using a deburring tool.
 - b. PE & PP pipe require scraping according to DUS guidelines using Asahi P.R.E.P. tools to remove oxidation
 - c. Clean the pipe and fittings with lint free paper and cleansing agents (isopropyl alcohol or similar).
 - d. Mark the socket depth with a scraper knife or marker on the pipe to ensure proper insertion depth of the pipe during welding.
 - e. Thoroughly clean heater inserts before each weld.
3. Quickly push pipe and fittings in an axial direction into heater inserts until the pipe bottoms (or meets the marking). Avoid twisting while heating. Hold in place for the heat soak time (column A).
4. After the heat soak time, remove the fitting and pipe from the heating element and immediately push them together within the changeover time (column B), without twisting them, until both welding beads meet. The changeover time is the maximum period of time between the removal from the heating element and the final settings of the components.
5. Components should be held together and allowed to cool, per the specified cool-down time, prior to stressing the joint.

Visual Inspection

During the final joining step, it is important that the bead formed on the pipe meets the bead on the fitting. If the beads do not meet, a small gap will be present. Welds that have a gap between the fusion beads should be cut and rewelded (see Figure E-3). The bead on the pipe should be uniform around 360° of the pipe. Beads that vary in size or disappear altogether are a sign of improper heating and/or joining.

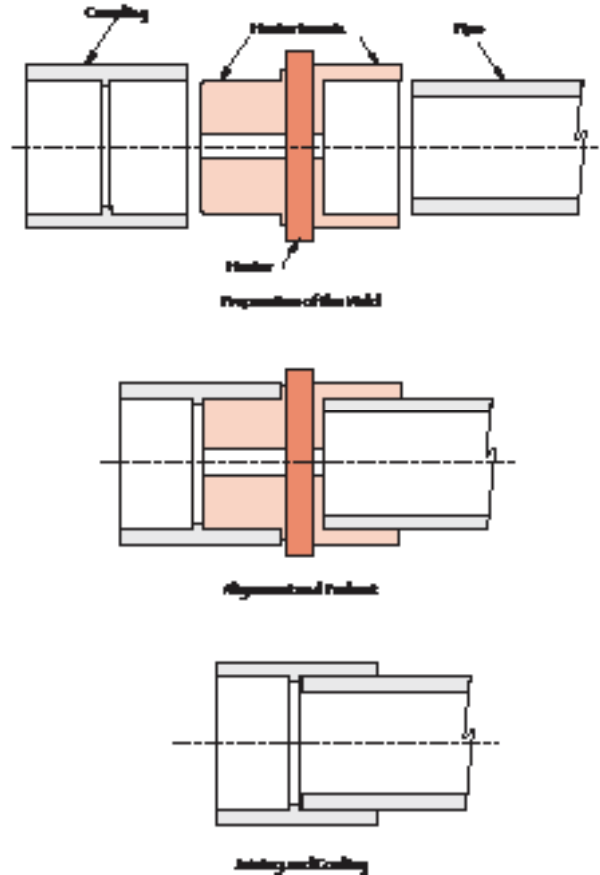

Figure E-2. Socket Fusion Welding Process

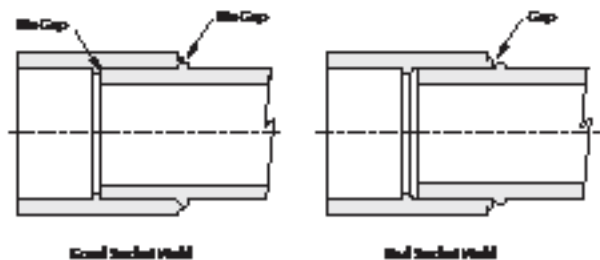

Figure E-3. Socket fusion welding samples

Pipe Size (Inches)	A	B	C
	Heat Soak Time	Change Over Time	Cooling Time
1" Pro 150	8	6	240

Table E-2. Sample Welding Data (time-sec)

Performing of Pressure Test

Before pressure testing, all welding joints have to be completely cooled down (as a rule, one hour after the last welding process). The pressure test has to be performed according to the relevant standard regulations. The piping system has to be protected against changes of the ambient temperature (UV radiation).

Devices for heating element socket welding are used in workshops as well as at building sites. As single-purpose machines, they should allow for a maximum degree of mechanization of the welding process.

Clamping Devices

Marks on work piece surfaces that are caused by special clamping devices for pipe components must not affect the mechanical properties of the finished connection.

Guide Elements

E Together with clamping devices and a heating element, the guide elements have to ensure that the joining parts are guided centrally to the heating element and to each other. If necessary, an adjusting mechanism can be provided.

Machine Design and Safety in Use

In addition to meeting the above requirements for construction and design, the following points should be considered for the machine design:

- Stable construction
- Universal basic construction (swivelling or retractable auxiliary tools and clamps)
- Quick clamping device
- Maximum degree of mechanization (reproducible welding process)

BUTT/IR

Butt Fusion (for single wall piping systems)

The butt fusion of PP, HDPE, PVDF, and E-CTFE is accomplished with Asahi/America’s recommended butt fusion welding equipment. Asahi/America provides welding equipment to handle all diameter sizes offered and has an extensive line of equipment available to buy or rent for every application.

The principle of butt fusion is to heat two surfaces at the melt temperature, make contact between the two surfaces, and then allow the two surfaces to fuse together by application of force. The force causes the flow of the melted materials to join. Upon cooling, the two parts are united. Nothing is added or changed chemically between the two components being joined. Butt fusion does not require solvents or glue to join material.

Butt fusion is recognized as the industry standard, providing high integrity and reliability. It does not require couplings or added material. The procedure, recommended by Asahi/America, conforms to ASTM D-2857 for Joining Practices of Polyolefin Materials and the recommended practices of the ASME B 31.3 Code.

Welding Process

Once the pipes or fittings have been secured in the proper welding equipment, as well as aligned and planed with the facing tool (planer), and the heating element is warmed to the proper temperature, welding proceeds as follows:

1. Follow the welding parameters (temperature, time, and force) provided with Asahi/America’s butt fusion equipment (see sample welding data in Table E-4).
2. Insert the heating element between secured pipes or fittings, making sure full contact is made around surfaces.
3. Apply full welding pressure, as shown in (Column A), until a maximum 1/64” ridge of melted material is present around the outside circumference of both pipes or fittings. This indicates that proper melt flow has been accomplished and further guarantees two parallel surfaces.
4. Reduce the pressure to the recommended melt pressure (Column B), and begin timing for recommended heat soak time (Column C).

5. At the end of the heat soak time, in a quick and smooth motion, separate the pipe fitting from the heating element, and then apply weld pressure (Column E). It is important to gradually increase pressure to achieve welding pressure. The weld must be performed within the allowable changeover time (Column D). Changeover time is the maximum period of time when either the pipes or fittings can be separated from the heating element, yet still retain sufficient heat for fusion. Bring the melted end together to its welding pressure.
6. The heat soak time may need to be increased in cold or windy environments. Several practice welds should be conducted at the installation site to ensure that welding can be performed, as a test of conditions. Consult Asahi/America for any modification of weld parameters.
7. A visual inspection must be performed as well. After joining, a bead surrounding the whole circumference will have been created. A good weld will have two symmetrical beads on both the pipe and fittings that are almost equally sized and have a smooth surface.
8. Allow components to cool to the touch or until a fingernail cannot penetrate the bead. This is recommended in ASTM D-2857, Section 9. The pipes or fittings may be removed from the welding equipment at the completion of the specified cooling time.
9. Do not put components under stress or conduct a pressure test until complete cooling time (Column F) has been achieved.



Pipe Size (Inches)	A	B	C
	Initial Melt Pressure	Melt Pressure	Heat Soak Time
2" Pro 150	23	2	60
Pipe Size (Inches)	D	E	F
	Change Overtime	Welding Pressure	Cooling Time
2" Pro 150	5	23	420

Table E-4. Sample Welding Data (time-sec, pressure-psi)

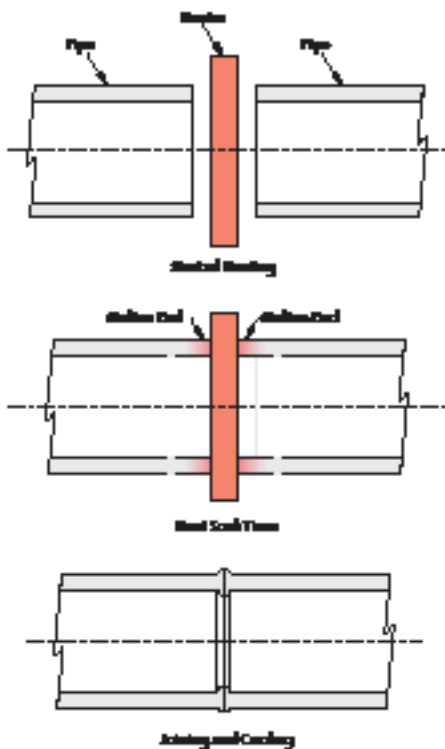

Figure E-4. Butt fusion welding process

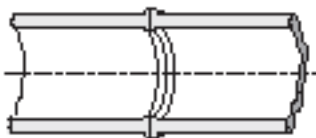

Figure E-5. Butt fusion welding example

Butt Fusion (for double wall piping systems)

Installation of Duo-Pro®, Chem Prolok™, Fluid-Lok®, and Poly-Flo® piping systems involves the use of thermal butt fusion for both the carrier and containment piping. Depending on the system design, the size, material, and layout will determine the required equipment. Asahi/America offers all of the necessary sizes and styles of equipment for any installation type.

Systems that are fully restrained and consist of the same carrier and containment materials can take advantage of the simultaneous butt fusion method. Simultaneous fusion allows for the quickest and easiest installation by conducting the inner and outer weld at once. For Duo-Pro® designs that consist of dissimilar materials or require the inner (carrier) piping to be loose for thermal expansion, use the staggered welding procedure.

Staggered welding consists of welding the inner carrier pipe first and the containment piping second. Finally, if a leak detection cable system is required, special heating elements or procedures are provided to accommodate for pull ropes.

The basic installation techniques for double containment piping systems follow the principles that apply to ordinary plastic piping applications.

Simultaneous Butt Fusion Method

The object of simultaneous fusion is to prepare both the carrier and containment pipe so that both pipes are fixed to each other and therefore can be welded at the same time. In some systems, such as Asahi/America's Fluid-Lok® and Poly-Flo®, only simultaneous fusion can be performed due to their design. The net result of the simultaneous method is a substantial reduction of labor and equipment requirements.

As previously discussed, simultaneous fusion is only applicable for welding installations that have the same carrier and containment material. In addition, simultaneous fusion is used for systems that are completely restrained. Prior to using the simultaneous method, an analysis based on operating conditions is required in order to determine the suitability of a restrained design. Contact Asahi/America's Engineering Department for assistance.

Equipment

For simultaneous welding, standard butt fusion equipment used for single wall systems is used. No special heating elements are required. For Duo-Pro® and Fluid-Lok® systems, hot air or extrusion welding equipment is necessary to weld the support discs and spider clips to the pipes. Hot air welding is not used for any pressure rated components.

Fittings

Fittings used for simultaneous fusion are either molded or prefabricated at the factory with the necessary support discs. Prefabricated fittings greatly reduce the amount of hot air welding required in the field and, in turn, reduce labor time. If an installation is pipe-intensive, labor costs may be reduced by ordering prefabricated pipe spools in longer dimensions.

Welding Procedure

The welding theory for double containment is the same as for single wall pipe. Asahi/America has developed welding tables for the appropriate heating times and forces for simultaneous fusion. The following procedure outlines the necessary steps for simultaneous fusion.

Double Wall Pipe Assembly

Pipes and fittings in a simultaneous double wall system from Asahi/America are always prefabricated at the factory and supplied to a job-site ready for butt fusion. However, when varying lengths are required, in-the-field assembly is necessary. In staggered welding systems, pipe and fitting assembly is common. The basic procedure for properly assembling Duo-Pro® and Fluid-Lok® components is outlined below.

In double containment piping assembly, proficiency in hand and extrusion welding procedures is necessary.

1. A good weld requires proper preparation of the material. The pipe should be free of any impurities, such as dirt, oil, etc. Additionally, some thermoplastics develop a thin layer of oxidized molecules on the surface that require scraping or grinding of the material. Another effect, especially with HDPE, is the migration of unchained lower density molecules to the surface caused by internal pressure of the material. This gives the usually “waxy” surface appearance of HDPE. Grinding or scraping is required. Wipe off any dust with a clean cloth. Do not use solvents or cleaners; they introduce chemicals with unknown and likely negative effects.

2. Using Table E-5, place the molded or fabricated support spider clips, with tops aligned, on the carrier pipe, and then hot gas (PP) or extrusion weld (HDPE) the clips into place, as shown in Figure F-6. Use the required amount of clips on the full lengths of the carrier pipe.

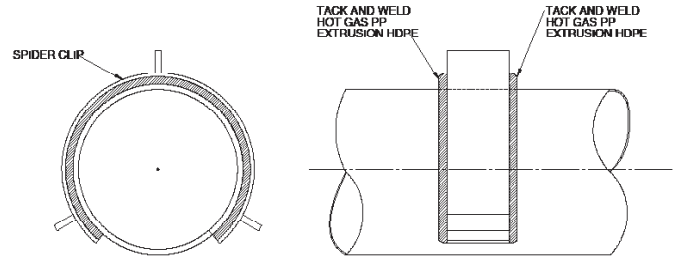

Figure E-6. Spider clip attached to carrier pipe

3. Insert carrier pipe into containment pipe. Be sure the two pipes have been stored in the same environment for equal expansion or contraction to occur before welding end centralizers into place.

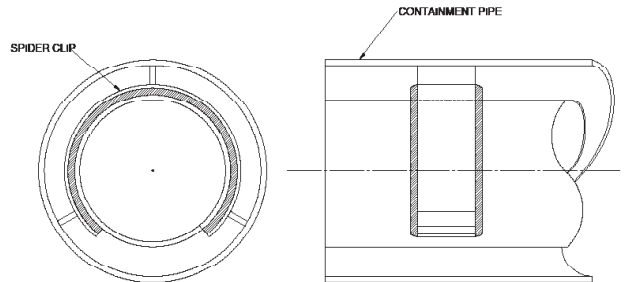

Figure E-7. Carrier pipe and spider clips inserted into containment pipe

4. For simultaneous welding, end centralizers, known as support discs, are hot air or extrusion welded to the carrier and containment pipes. This prevents any movement of the carrier pipe during the butt fusion process. The alignment must match that of the spider supports for the installation of leak detection cables, as well as for leak flow. In fitting assemblies, install end centralizers only. All centralizers are installed approximately 1” from the ends using a 4mm welding rod.

Carrier	Pro 150	Pro 45	PVDF	Halar	HDPE 11	HDPE 17	HDPE 32
1"	42	NA	42	44	30	NA	NA
2"	54	NA	54	59	42	36	NA
3"	66	NA	66	69	48	42	36
4"	72	42	72	72	54	48	42
6"	84	48	84	NA	66	60	54
8"	90	48	90	NA	78	72	60
10"	102	54	102	NA	84	78	66
12"	114	60	114	NA	96	84	72
14"	120	66	NA	NA	102	90	78
16"	126	72	NA	NA	108	96	84
18"	138	78	NA	NA	114	102	90
20"	NA	78	NA	NA	120	108	96

NOTE: At 68°F (See Appendix A for temperature adjustments.)

Table E-5. Double Containment Internal Support Spacing (inches)

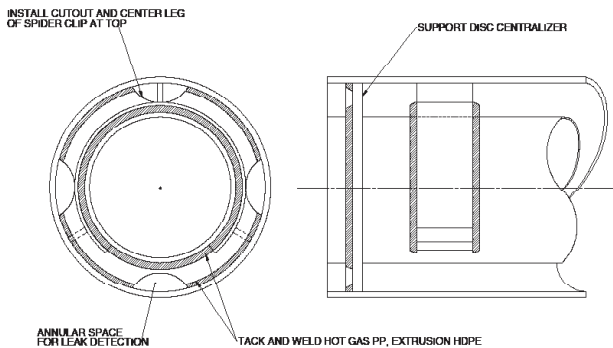

Figure E-8. Support disc attached to carrier and containment pipes

- The pipe and fitting with support discs are now ready for simultaneous butt fusion using the recommended ASTM D-2857 joining practices.

Butt Fusion Procedure for Double Wall Pipe Without Leak Detection Cable Systems

Simultaneous fusion as outlined below is ideal for:

- Duo-Pro® systems made of similar carrier and containment material
- Fluid-Lok® HDPE systems
- Restrained double wall systems only
- All Poly-Flo® systems

Fusing Duo-Pro® and Fluid-Lok® is accomplished with Asahi/America's recommended butt fusion welding equipment. Asahi/America provides welding equipment to handle all diameters and system configurations. Equipment is available for rental or purchase.

The principle of butt fusion is to heat two surfaces at a fusion temperature, make contact between the two surfaces, and then allow the two surfaces to fuse together by application of force. After cooling, the original interfaces are gone and the two parts are united. Nothing is added or changed chemically between the two pieces being joined.

Butt fusion is recognized in the industry as a cost-effective joining method of very high integrity and reliability. The procedure, recommended by Asahi/America, conforms to ASTM D-2857 for Joining Practices of Polyolefin Materials and the recommended practices of the ASME B 31.3 Code (Chemical Plant and Petroleum Refinery Piping).

The procedure is outlined as follows: Once the pipes or fittings have been secured in the proper welding equipment with the tops and annular space aligned, and the heating element is warmed to the proper temperature, welding should proceed as follows:

1. Follow the welding parameters provided with Asahi/America butt fusion equipment (see sample welding data in Table E-6).

Pipe Size (Inches)	A	B	C
	Initial Melt Pressure	Melt Pressure	Heat Soak Time
2" x 4"	40	5	60
Pipe Size (Inches)	D	E	F
	Change Over Time	Welding Pressure	Cooling Time
2" x 4"	4	40	420

Table E-6. Sample Welding Data (time-sec, pressure-psi)

2. To ensure that the carrier pipe is planed and flush with the containment pipe, put four marks on the end of the carrier pipe at three, six, nine, and twelve o'clock prior to planing. If the outer pipe is completely planed and the marks on the carrier have been removed, planing is complete. With experience, visual inspection can determine that the planing process is complete. Remove all shavings, and recheck alignment. For Poly-Flo®, the pipes should be installed in the machines so that the ribs do not align, thereby allowing any fluid to flow to the low point of the annular space in the event of a leak.

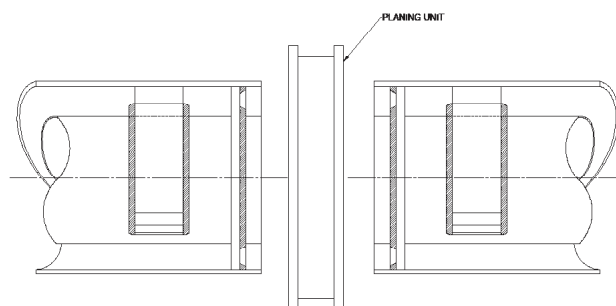

Figure E-9. Plane carrier pipe flush with containment pipe

3. Insert a heating element between secured pipes or fittings, making sure full contact is made around surfaces.

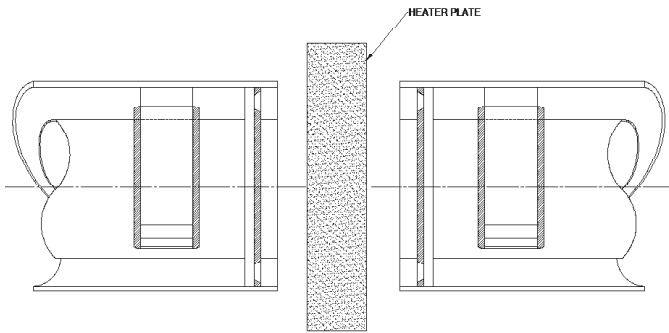

Figure E-10. Insert heating element between pipe ends

4. Apply full welding pressure (as shown in Table E-6, Column E) until a maximum 1/64" ridge of melted material is noticed around the outside circumference of the components. This indicates that proper melt flow has been accomplished and further guarantees two parallel surfaces.

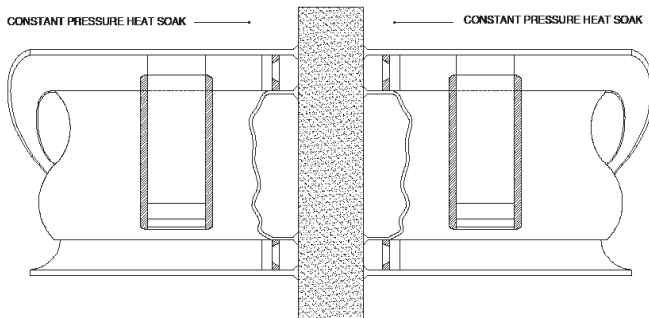

Figure E-11. Apply welding pressure to the heating element

5. Reduce the pressure to the recommended melt pressure (Column B), and begin timing for the recommended heat soak time (Column C).
6. At the end of the heat soak time, in a quick and smooth motion, separate either the pipes or fittings, remove the heating element, and then apply weld pressure (Column E). It is important to gradually increase pressure to achieve welding pressure in Column E. The weld must be performed within the allowable changeover time (Column D). Changeover time is the maximum period of time when either the pipes or fittings can be separated from the heating element, yet still retain sufficient heat for fusion. Bring the melted ends together to its welding pressure.

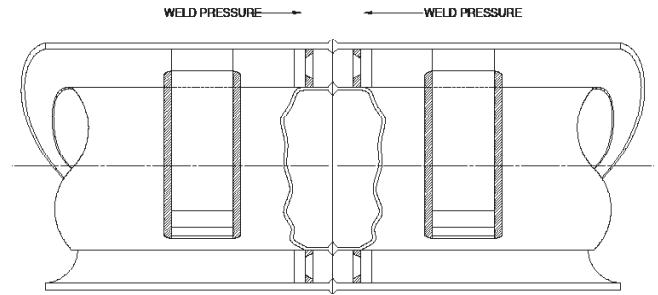

Figure E-12. Bring pipe ends together, and apply welding pressure

7. The heat soak time should be increased if the environment is cold or windy or if either the pipes or fittings are cold. As a test of environmental conditions, several practice welds should be done at the installation site to ensure that welding can be performed. Consult with Asahi/America for recommendations on cold weather welding.

8. A visual inspection must be performed as well. After joining, a bead surrounding the whole circumference will have been created. A good weld will have a symmetrical bead on both pipes or fittings and a smooth surface.

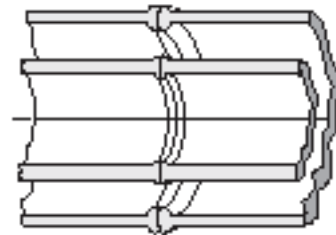

Figure E-13. Visual inspection of welds

9. Allow components to cool to the touch or until a fingernail cannot penetrate the bead. This is recommended in ASTM D-2857, Section 9. The pipes or fittings may be removed from the welding equipment at this time.
10. Do not put pipe or fittings under any type of stress or conduct a pressure test until the complete cooling time (Column F) has been achieved.



Butt Fusion Procedure for Double Wall Pipe With Leak Detection Cable Systems

This method is available for the following systems:

- Duo-Pro® made of similar material on the carrier and containment
- Fluid-Lok® HDPE system
- Restrained systems only

Asahi/America split-leak detection heating elements allow both the carrier and containment pipes to be welded simultaneously, with a pull cable in place. The mirror design, as shown in Figure E-14, is capable of splitting apart and wrapping around a wire. The small hole centered at the bottom of the heater allows a pull wire to be in place during the fusion process. Once the pipe is heated, the heating element is split apart and removed, leaving the wire in place for the final pipe joining.

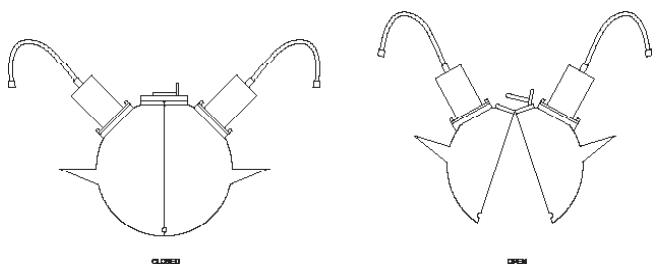

Figure E-14. Split heating elements for leak detection systems

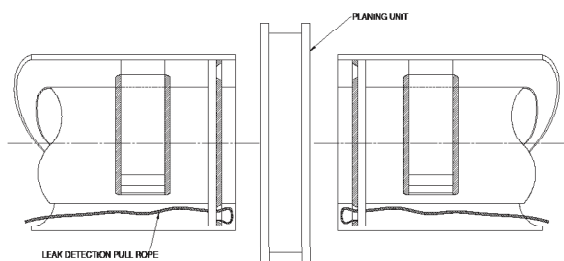

Figure E-15. Planing ends with pull rope installed

A short piece of wire is attached to the pull rope on both ends after planing. The wire runs through the heater during welding in order to prevent the damaging or melting of the pull rope (see Figures E-15 to E-18). After each section is complete, the wire is pulled down to the next joint to be welded. The installation of the pull rope is at the six o'clock position. A continuous pull rope, free from knots and splices, should be pulled through as the system is assembled.

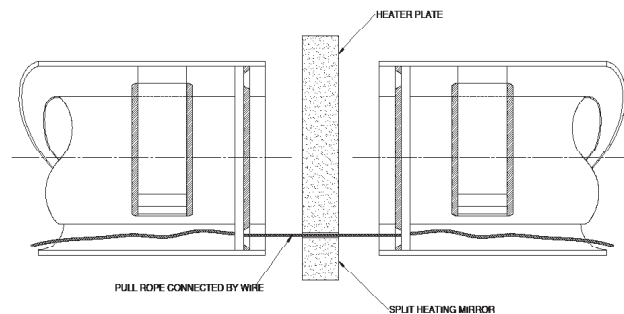

Figure E-16. Pull rope connected by wire through heating element

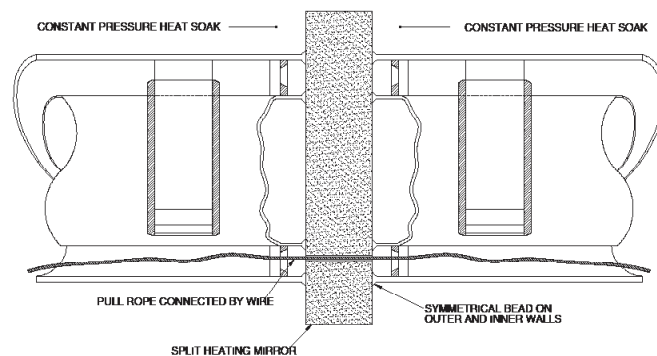

Figure E-17. Pipe ends heated with pull rope installed

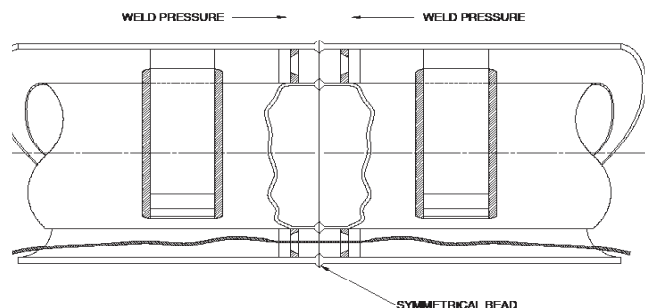

Figure E-18. Welding complete with pull rope installed

Follow the standard butt fusion procedure for welding. Other methods for welding with a solid heating element are available that will accommodate a leak detection cable system.

Staggered Butt Fusion Method

Using the staggered fusion procedure to assemble a Duo-Pro® system is more complicated and labor-intensive than simultaneous fusion. However, it offers the ability to install a double containment system with a flexible inner pipe or with different carrier and containment materials. Asahi/America provides all of the necessary equipment for this welding method.

In staggered welding, the carrier pipe is welded first, followed by the containment pipe. In a staggered system, there are no end support discs. This allows for the movement of the carrier components. It is important to plan which welds will be made and in what order. Enough flexibility is required to move the inner pipe out from the outer pipe to perform a carrier weld.

In long, straight runs, the procedure is simple, due to significant carrier pipe movement. In systems that are fitting-intensive, the procedure becomes more difficult because the pipe movement is limited to the amount of annular space between the carrier and containment fittings (see Figure E-19).

Welding Procedure

1. Begin by attaching spider clips to the carrier pipe (follow steps in double wall pipe assemblies).
2. Insert carrier pipe or fittings into the appropriate containment line. At the start of a system, it may be easier to weld the carrier first and then slide the containment pipe over the carrier pipe. However, as the installation moves along, this will not be possible.
Note: If containment piping has been roughly cut, make sure to plane it prior to welding the carrier pipe. Once the carrier is welded, the containment pipe cannot be planed.
3. In the machine, use the two innermost clamps to hold the carrier pipe for welding. Use the outer clamps to hold the containment pipe in place. In cases where movement is limited, fitting clamps will be necessary to hold the carrier pipe.
4. Once all of the pieces are locked in place, weld the carrier pipe using standard butt fusion techniques (see Figures E-19 A and E-19 B).
5. Once the carrier weld is complete, remove the inner clamps and pull the containment pipe together for welding (see Figures E-19 C and E-19 D). At this point, switch all clamps to containment sizing. It may be preferable to use two machines to eliminate the constant changing of clamps. Also, in some designs, two machines may be required to weld the two different diameter pipes.
6. To weld the containment pipe, a split annular mirror is required (see Figure E-19 F). The mirror is hinged to let it wrap around the carrier pipe while welding the containment pipe.
7. It is important to ensure that the mirror is properly centered so it does not rest on and melt the carrier pipe.
8. Once the mirror is in place, the welding procedure is the same as standard single wall butt fusion.

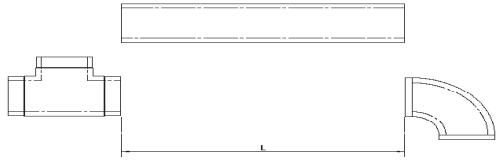

A. Cut carrier and containment pipes to length L

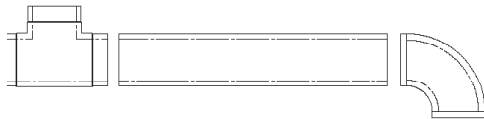

B. Pull carrier elbow out of containment elbow and weld to carrier pipe



E C. Weld containment elbow to containment pipe



D. Flex carrier elbow and pipe toward tee and weld to carrier tee pipe

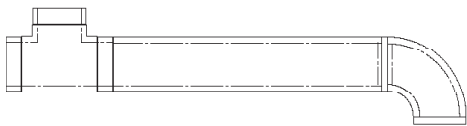

E. Weld containment pipe to containment tee

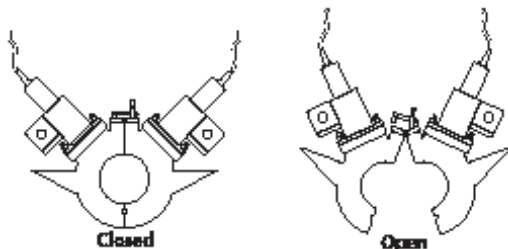

F. Annular heating element

Figure E-19. Staggered butt fusion

Helpful Hints

- When welding PVDF and Halar[®], move swiftly while removing the mirror and joining the pipes. Delayed reaction will cause the material to cool and a “cold weld” to form. PVDF and Halar[®] cool off more quickly than polypropylene.
- Always plan welding so the longest and heaviest section of pipe is positioned on the stationary side of the welding machine.
- Start at one end, and work to the other end of the pipe system. Do not start on two different ends and meet in the middle. Moving the pipe for welding will be extremely difficult or impossible.
- When planing, long strips indicate that you are flush all the way around.
- Consult the factory for a proper equipment recommendation for the system being installed.
- Machines are extremely adaptable and can be positioned in many ways to accommodate difficult welds.

IR Fusion

Improving upon conventional butt fusion, IR welding uses a non-contact method. IR welding uses the critical welding parameters of heat soak time, changeover time, and joining force as found with butt fusion. However, by avoiding direct contact with the heating element, IR fusion produces a cleaner weld with more repeatable and smaller bead sizes. The end result is a superior weld for high purity applications.

The graph in Figure E-21 outlines the forces applied during the non-contact joining process. Notice that the ramp-up force to full joining pressure is a smooth curve where force is gradually ascending over time. Even force build-up is critical to join material without creating a cold joint.

Welding Process

Material is prepared for IR fusion by creating smooth, arid, and level surfaces among the ends to be joined. Butting the material against an internal planer acts as a centering and leveling device. The planer is then used to cut a clean and smooth surface. The material should then be checked for vertical and horizontal alignment. Welding machines should allow for minor adjustments to the vertical and horizontal orientation of the material.

Once alignment has been verified, the material is heated by close proximity to the heating source. Through radiant heat and proper heat soak time, the material becomes molten to allow physical bonding between the two pieces. After the heating source has been removed, the material should be joined together in a steady manner, slowly ramping up the force until the desired joining force has been achieved.

Ramping up and monitoring the force is critical for repeatable and successful IR welding. This ensures that the molten material has joined at the right force and prevents against cold welds, which are caused by the molten material being overly pushed to the inside and outside of the weld zone.

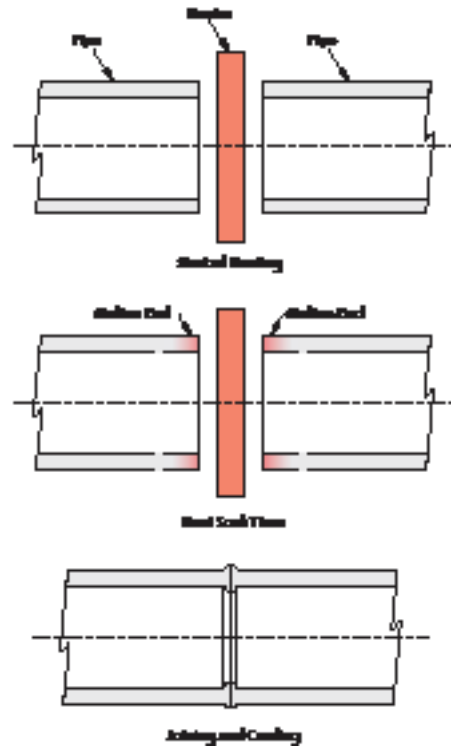

Figure E-20. IR fusion welding process

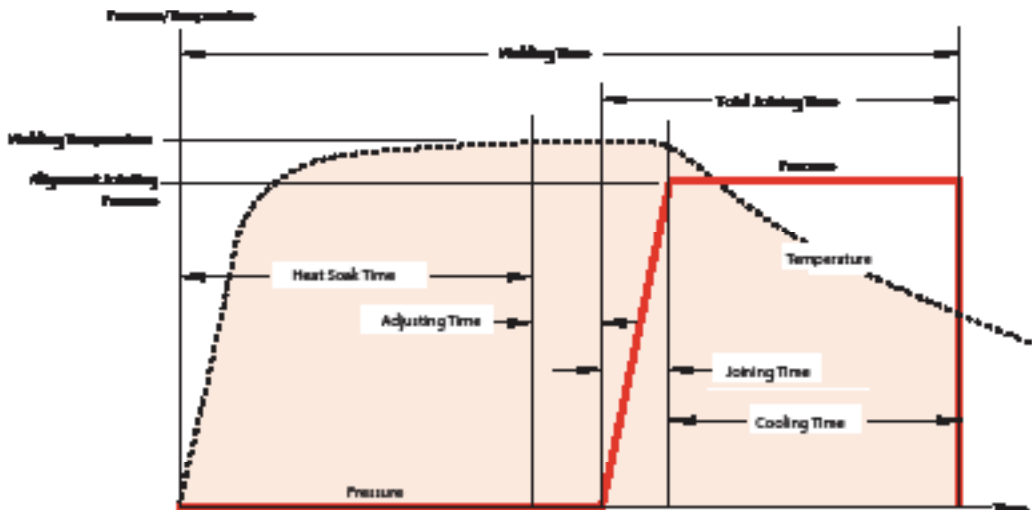

Figure E-21. IR fusion timing diagram

ELECTROFUSION

Electrofusion Welding

Electrofusion is a simplified and safe method of joining pipe and/or fittings based on melting the outer surface of the pipe and the inner surface of the electrofusion coupling by using an integral electric wire. Electrofusion is a cost-effective method for joining polypropylene and HDPE pipe. As an alternative to butt fusion, electrofusion can be used for repairs, double containment assembly, and difficult connections in tight quarters.

Welding Equipment

The Asahi electrofusion equipment performs the welding for all of Asahi/America's electro fittings. The control box has a computerized command system for fully automatic control and energy supply monitoring. Each fitting has a bar code label, which contains the information needed for correct fusion. The welding time is preprogrammed at the factory and set by the use of the bar code. Simply scan the bar code to set up the machine for material to be joined.

Preparation Before Welding

Cut pipe at right angles, and mark the insert length (insert length = socket length/2). For successful welding, it is essential to clean and scrape the surface of the parts to be joined. In addition, cuts must be straight to ensure proper insertion into the coupling. Scraping must be done using a proper hand-operated or mechanical scraper. Do not use tools such as rasp, emery paper, or sand paper.

Slide the socket on the prepared end of pipe right to its center stop until it reaches the marking. Insert the second pipe end (or fitting) into the socket, and clamp both pipes into the holding device. The clamping device protects the components from being pushed out during fusion.

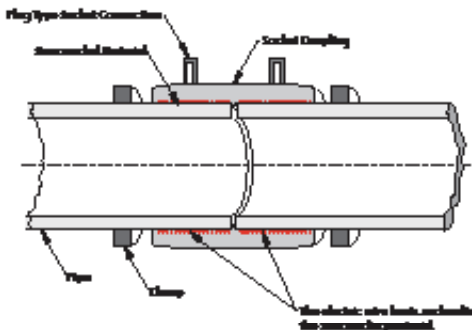

Figure E-22. Electrofusion welding setup

Welding Procedure

Observe the operating instructions for the welding device, as individual tools may vary. Plug-type socket connections should be turned upward and then connected with the cable.

After the welding equipment has been properly connected, the welding parameters are input by means of the bar code reader. An audio signal will acknowledge the data input.

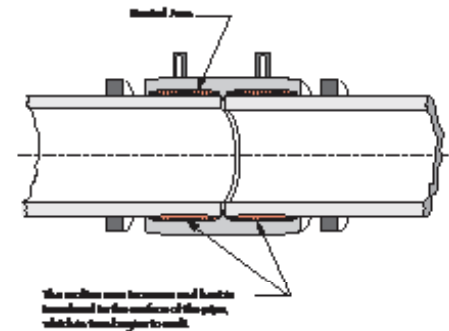

Figure E-23. Initial heating occurs in coupling

Pressing the start key initiates the welding process. The time on the display is also programmed into the machine and allows the correct heating time for various pipe sizes.

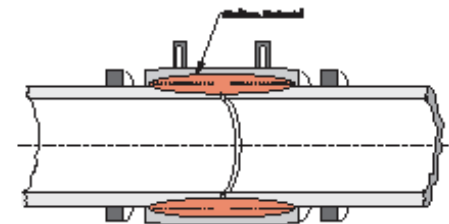

Figure E-24. Molten material from both coupling and pipes form weld

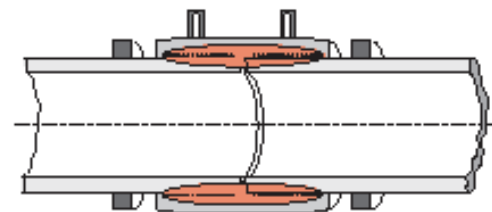

Figure E-25. Completed electrofusion weld

During the welding process (including the cooling time), the clamping device should remain in place. The end of the welding process is indicated by an audio signal.

The welding indicator on the socket performs visual control.

Before pressure testing, all welded joints must have completely cooled down based on the welding parameters provided with the equipment. The pressure test must be performed according to recommended procedures.

HOT AIR

Welding Method

Hot air (gas) welding is the process of fusing a bead of material against a like material. This welding is common with sheet fabrication and applications not requiring pressure resistance. Asahi/America uses hot air (gas) welding to locate support discs for pipe centering in its Duo-Pro® system.

In hot air (gas) welding, the heat transfer medium is a heated gas, either nitrogen or clean air. Originally, the use of nitrogen proved most successful, preventing material contamination and oxidation. With today's material quality and equipment technology, nitrogen is becoming less common, except with critical materials. The combination of clean, oil and moisture-free air with the controlled temperature proves equally successful, eliminating the continuous expense of the inert gas. The temperature of the hot air ranges between 572°F and 662°F (300°C and 350°C) for HDPE and 536°F to 626°F (280°C to 330°C) for PP, when outside welding conditions are about 68°F (20°C). The temperature range will vary with changing ambient conditions.

To accomplish high-quality welds, it is important that the fillers (welding rod) are of the same material and type. The most common welding fillers are 3mm and 4mm round. There are also special profiles, such as oval and triangular rods. The welding tip used must also match the cross section of the welding rod.

Qualification of Welder and Requirements on Welding Devices

The plastics welder must have obtained the knowledge and skill required for the performance of welding processes. As a rule, this would mean that he is a qualified plastics worker and welder who continuously

practices or displays long-time experience. Hot gas welding machines have to comply with the requirements, according to guideline DVS 2208, part 2.

Welding of E-CTFE

The choice of gas is a very important factor in E-CTFE welding. It is not necessary to use nitrogen in E-CTFE welding; good quality E-CTFE welds can be obtained when a clean and dry source of air is used. Welding in nitrogen is recommended only when the welding facility lacks a clean and dry source of air.

Safety Precautions for E-CTFE

When welding E-CTFE, melt temperatures of > 572°F (300°C) release hydrogen chloride and hydrofluorics. They could be toxic at higher concentrations and should not be breathed in. The recommended load limit, according to TWA, is 5ppm for HCl and 3ppm for HF. If E-CTFE vapors are inhaled, the person should be brought out into fresh air, and medical aid should be requested immediately, as there is a danger of polymer fever. The following safety measures should be considered:

- Have good ventilation in the workplace (or use breathing protection)
- Use eye protection
- Use hand protection

Air Supply

For hot gas welding, air is normally supplied by a compressed air network, compressor, pressure gas bottle, or ventilator. The air supplied has to be clean and free of water and oil to avoid decreases in the quality of the welding seam and the lifetime of the welding devices. Therefore, adequate oil and water separators have to be used. The air volume supplied to the device has to be adjustable and maintained constantly, as it is a main factor influencing the temperature control of the device.

Welding Devices (with built-in ventilator)

The devices are comprised of a handle, a built-in ventilator, heating, a nozzle, and an electrical connecting cable. Due to their construction features, they can be used at sites where an external air supply is not available. On account of their dimensions and weight, they are less suitable for longer lasting welding processes.



Requirements for Design

The ventilator has to supply the quantity of air required for welding various types of plastics to all nozzles (see DIN 16 960, part 1). The electrical circuit has to ensure that the heating is only turned on when the ventilator is operating. The noise level of the ventilator has to comply with the relevant stipulations.

Safety Requirements

The nozzles used for the particular devices have to be securely fastened and easily exchangeable, even when heated. The material must be corrosion-proof and of low scaling. In order to prevent heat from dissipating, the surface of the nozzle has to be as smooth as possible, (e.g. polished). For reducing friction, the inner surface of the slide rail of the drawing nozzle has to be polished. The same applies to the sliding surfaces of tacking nozzles. In order to avoid strong air vortex at the outlet of the nozzle, the round nozzles have to be straight for at least $5 \times d$ (d = outlet diameter of the nozzle) in front of the outlet.

E

Preparations for Welding

Before starting the welding process, check the heated air temperature adjusted on the welding machine. Measurement is performed by means of a control thermocouple, inserted approximately 5 mm into the nozzle, and with rod-drawing nozzles in the opening of the main nozzle. The diameter of the thermocouple must not exceed 1 mm. Air quantity is measured by means of a flow control instrument before the air stream enters into the welding machine.

Processing Guidelines

Install welding tent or equivalent if weather conditions suggest. A good weld requires proper preparation of the material. The part should be free of any impurities such as dirt, oil, etc. Additionally, some thermoplastics develop a thin layer of oxidized molecules on the surface that require scraping or grinding of the material. Another effect, especially with HDPE, is the migration of unchained lower density molecules to the surface caused by internal pressure of the material. This gives the usually “waxy” surface appearance of HDPE. Grinding or scraping of the surface is required. Wipe off any dust with a clean cloth. Do not use solvents or cleaners; they introduce chemicals with unknown and likely negative effects.

The forms of the welding seams on plastic components generally correspond with the welding seams on metal

parts. Parts 3 and 5 of the guideline DVS 2205 are valid with respect to the choice of welding seam forms on containers and apparatus. In particular, pay attention to the general principles for the formation of welding seams. The most important welding seam forms are: V-weld, Double V-weld, T-weld, and Double T-weld.

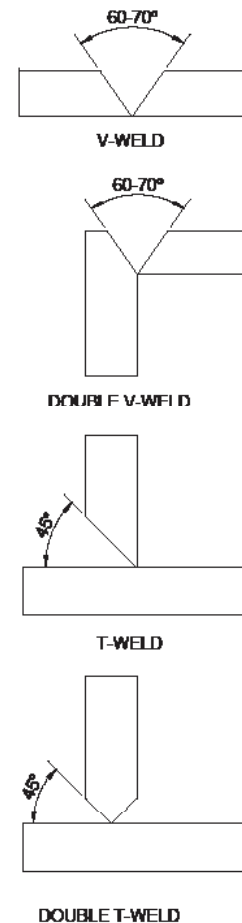

Figure E-26. Typical welding seam forms

Tack Welding

The initial step in the welding process is the “tack weld.” The objective is to put the parts into place, align them, and prevent any slippage of the material during the structural welding process. Welders should use their own discretion when applying an intermittent or continuous tack. Larger structures and thick gauged materials may require addition clamping.

High-Speed Welding

In this process, a filler material, the welding rod, is introduced into the seam to give supportive strength. Standard rod profiles are round or triangular. A triangular rod is a single supportive weld and does not allow for the kind of surface penetration achieved with a round welding rod.

A round welding rod is used where heavy-duty welds are required. It allows the fabricator to lay several beads of welding rod on top of each other. This way, a relatively thin welding rod can be used to produce a strong weld.

By performing a few practice welds, the welder should develop the speed and force necessary to complete a successful weld. Heat the welding rod within the rod-drawing nozzle, and push it into the welding groove. The force applied on the rod controls the speed of the welding. The operator should look for a small bead of melted rod on both sides. Apply additional welds to fill the groove.

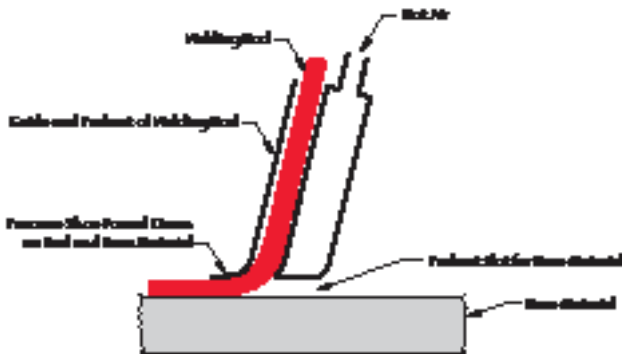

Figure E-27. High-speed welding process

Freehand

The oldest method of welding filler rod is freehand. This process is much slower than high-speed welding, but it must be used where very small parts are being welded or where the available space prohibits the use of high-speed welding tips. The only nozzle used in this process is a small jet pipe with an opening of 1/8" or 5/32" to concentrate the heat. The welder performs a waving action of the nozzle at the base material and the welding rod with an "up and down" and "side to side" motion to bring the rod and material to melting form. Hand apply pressure vertically at 90° to begin. After reaching the correct amount of pressure and heat for the

rod and base material, a small wave of molten material forms in front of the welding rod. If bent backward, the welding rod will stretch and thin out; if bent forward, no wave will occur in front, resulting in insufficient pressure. Freehand welding requires a highly skilled operator and should be avoided if a simpler method can be used.

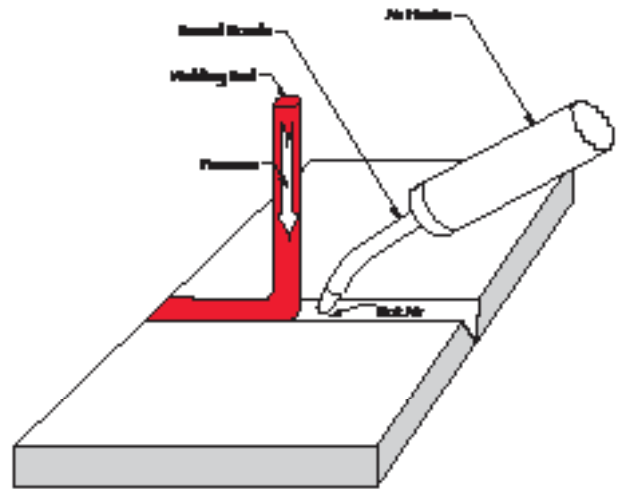

Figure E-28. Freehand welding

Structure of Welding Seam

The first layer of the welding seam is welded with filler rod, diameter 3 mm (except for material thickness of 2 mm). Afterward, the welding seam may be built up with welding rods of larger diameters until it is completely filled. Before welding with the next welding rod, the welding seam, which has been formed with the preceding welding rod, has to be adequately scrapped.

Additional Machining of Welding Seam

Usually, welding seams do not need reworking; however, pay attention to the fact that the thickness of the base material must be maintained.

General Requirements

- Safe functionality at a temperature application range between 23 and 140°F (-5 and 60°C)
- Safe storage within a temperature range of 23 and 140°F (-5 and +60°C)
- Adequate corrosion protection against moisture entering from the outside
- As light as possible

- Favorable position of the gravity center
- Functionally formed handle
- No preferred direction in relation to the supply lines
- Nozzle that can be fixed in any position
- Easily accessible functional elements
- Feed hoses and cables can be extended by the welder with minimal effort and do not kink or twist in proper operation
- Safe storage of equipment when the welding work is finished or during interruptions
- Used nozzles are easy to remove and to fix in heated state
- Indefinitely variable power consumption
- If possible, handle with built-in control system
- Operating elements arranged in a way that prevents unintentional changes
- Material of handle: break-proof, thermo-resistant, thermo-insulating, and non-conducting
- Corrosion-proof hot gas supply pipes of low scaling
- Constant welding temperature achieved after a maximum of 15 minutes

Safety Requirements:

The devices have to be safe with consideration for all personal injuries. In particular, the following requirements apply:

- Parts next to hands should not be heated to temperatures above 104°F (40°C), even after longer use
- Protection against overheating (e.g., due to lack of air) of the device has to be present
- Equipment surfaces presenting a burn hazard are to be kept as small as possible, or isolated and labeled as required

- Sharp edges on equipment and accessories are to be avoided

EXTRUSION

Extrusion Welding

Extrusion welding is an alternative to multiple pass hand welding and can be used whenever physically possible to operate the extruder. Extrusion welding is used for joining low pressure piping systems, constructing tanks and containers, joining liners (for buildings, linings for ground work sites), as well as completing special tasks.

This welding technique is characterized as follows:

1. The welding process is performed with welding filler being pressed out of a compound unit
2. The welding filler is homogenous with the material being joined
3. The joining surfaces have been heated to welding temperature
4. The joining is performed under pressure

Qualification of Welder and Requirements of Welding Devices

The plastics welder must have obtained the knowledge and skill required to perform the welding processes. As a rule, this would mean that he is a qualified plastics worker and welder who is continuously practicing or who displays long-time experience. For extrusion welding, several kinds of devices may be used. The most common device is a portable welding device consisting of a small extruder and a device for generating hot air. The welding pressure is applied onto the Teflon® nozzle, directly fastened at the extruder, which corresponds to the welding seam form. Depending on the type of device, the maximum capacity of the welding fillers is about 4.5 kg/h.

Preparation of Welding Seam

The adjusting surfaces and the adjacent areas have to be prepared adequately before welding (e.g., by scraping). Parts that have been damaged by influences of weather conditions or chemicals have to be machined until an undamaged area appears. This process must be adhered to, especially when performing repair work.

Do not use solvents or cleaners; they introduce chemicals with unknown and likely negative effects, which cause them to swell. In order to equalize higher differences in temperature between the different work pieces, the work pieces have to be stored long enough at the workplace under the same conditions.

Welding Seams

When choosing welding seam forms for containers and apparatus, consider the general technical principles for welding seam formations. Generally speaking, single-layer seams are welded on extrusion welding. If it is not possible to make DV welds on welding of thicker semi-finished products, multi-layer seams can also be performed. The welding seam should laterally extend by about 3 mm beyond the prepared welding groove.

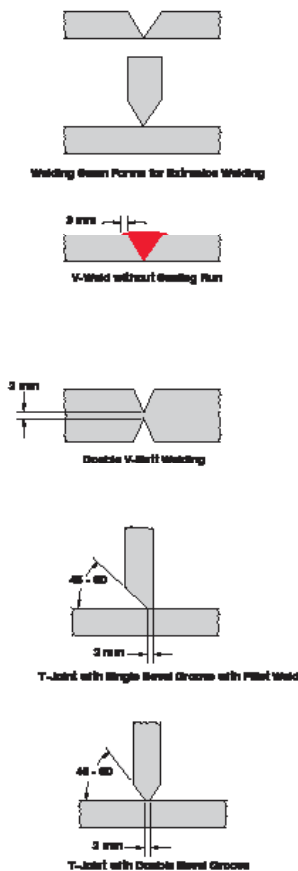

Figure E-29. Welding seam forms for extrusion welding

Equipment and Procedure

For extrusion welding, a portable welding device consisting of a small extruder and a device for

generating hot air are the most common devices.

An extruder uses either pellets or welding rods as a filler material. Do not use pellets or rods of unknown origin, uncontrolled composition, or regenerated material for welding. Make sure the filler is dry and clean before beginning the welding process. The extrusion welder includes a melting chamber with an extrusion screw, driven by an electric motor.

With the pellet extruder, the pellets are gravity fed from a hopper into the melting chamber. A rod extruder has a feed mechanism attached to the rear of the extrusion screw that pulls the welding rod into the melting chamber. The adjusting surfaces of the parts to be welded are heated up to the welding temperature by means of hot air passing out of the PTFE nozzle on the welding device. The welding filler, continuously flowing out of the extruder device, is pressed into the welding groove. The welding pressure is applied onto the PTFE nozzle, directly fastened at the extruder end, which corresponds to the welding seam. The discharged material pushes the welder ahead, determining the welding speed.



Lap Joint

In order to accomplish sufficient heating and thorough welding, it is necessary to provide an air gap depending on wall thickness (width of air gap should be 1mm minimum).

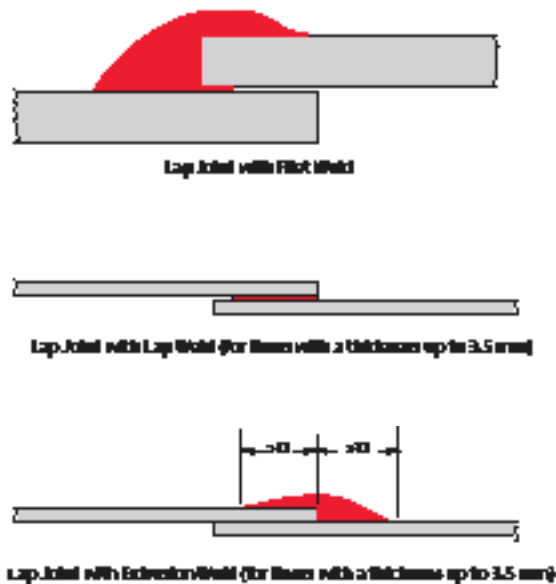
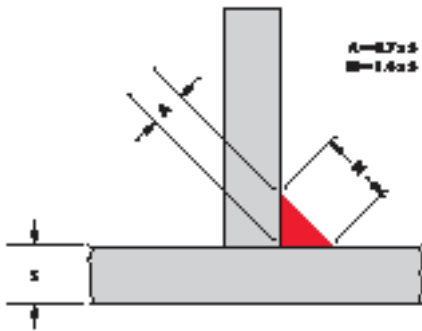

Figure E-30. Lap joints



NOTE: If material thickness does not match, use the “s” value from the thicker material to calculate bead size.

Figure E-31. Guideline for calculation of extrusion bead size

Visual Inspection

The primary function of the operator is to ensure that sufficient pressure is applied while also maintaining proper speed. Too little pressure will result in the molten mass not being formed into the final bead, and too much speed will cause the bead to thin. Both of these mistakes are easy to spot on the finished product.

Testing

The means for non-destructive testing are limited. Therefore, visual checking of the weld appearance becomes important. A good weld on thermoplastic material will show a slight distortion along the edge of the welding rod, indicating proper heat and pressure. Changes of the surface appearance of the base material right next to the weld indicate proper preheat temperature. A uniform appearance of this area indicates constant welding speed.

If the bead shows no distortion, the bead lacked proper pressure. Combine no distortion with a shiny appearance, and the bead lacks proper pressure and too much speed. On the other end of the scale, a welding temperature that is too high or a welding speed that is too slow will overheat the base material and/or welding rod. Overheating PP or PE will result in the bead looking extremely shiny and small splashes of material will seem to spray away from the bead.

In pipe seams, the best method for testing is to conduct a hydrostatic pressure test according to Asahi/America procedures.

MECHANICAL CONNECTIONS

Connection Technology

Connection systems have to be designed to avoid any kind of stresses. Stresses, which may arise from differences in temperature between installation and operation conditions, must be kept as low as possible by taking appropriate measures as described in the section design and calculation guide.

Depending on the pipe dimension, the following connection systems are applicable:

Dimension OD	IR fusion	Butt fusion	Beadless fusion	Flange connection	Union connection	Sanitary joint connection
20 mm-63 mm (1/2" to 2")						
75 mm-90 mm (2-1/2" to 3")						
75 mm-315 mm (2-1/2" to 12")						
355 mm-400 mm (12" to 16")						

Figure E-32. Applicable connection systems



Welding Personnel

The quality of the welded joints depends on the qualification of the welder, the suitability of the machines and appliances, as well as the compliance of the welding guidelines. The welding joint can be tested and inspected by destructive and/or visual methods.

The welding work must be supervised. The type and scope of supervision must be agreed on by the parties. It is recommended to record the procedure data in welding protocols or on data carriers.

Within the scope of the quality assurance, it is recommended to produce and test samples of joints before beginning and during the welding works.

Every welder has to be trained and must have valid proof of qualification. The intended application range may be decisive for the kind of qualification. The welding exam certificate, according to DVS 2212-1 in the groups I-4 res. I-8, in conjunction with the complementing training certificate issued by an authorized training institute or by the particular machine manufacturer, is valid as qualification proof.

Welding Machines

Utilize proven welding techniques for the joining of components; only approved welding machines should be used. The application of non-approved welding techniques can result in reduced joint quality in both strength and purity. In addition, welding parameters should be recorded for every performed welding. A print-out label with significant welding information is required to identify and evaluate every welding joint.

The utilized welding machines and appliances must correspond to the guidelines of the DVS 2208.

In general, the following facts should be considered for welding high purity thermoplastic piping systems:

- Application of suitable and approved welding machines
- Application of trained and certified personnel

- Consideration of the prescribed welding guidelines (parameters)
- Performance of the welding process in the cleanroom area
- Complete control and documentation of the performed welding operations

The design of a system should consider installation conditions, such as space and environment conditions. Based on the above criteria, the choice of welding technique is crucial for a successful installation. The installation should be planned to fabricate assemblies and subassemblies to reduce the amount of welds conducted in restricted (confined) locations.

Measures Before the Welding Operation

The welding zone must be protected against bad weather influences (e.g., moisture, wind, UV-radiation, and temperatures below 41°F (5°C) or higher than 104°F (40°C)). If it is ensured by suitable measures (e.g., preheating, tent, or heating) that a component temperature sufficient for welding can be kept, as far as the welder is not hindered in his handling, work may be carried out at any outside temperature. If necessary, an additional proof must be provided by carrying out sample welds under the mentioned conditions.

If the welding products are heated up unevenly under the influence of sunshine, a temperature compensation in the area of the welding joint can be reached by covering.

The pipe ends should be closed during the welding process.

The joining areas of the parts to be welded must be clean (free from dirt, oil, shavings, or other residues) and in a straight-cut, planed surface condition before start the welding process.

On applying any of these methods, keep the welding area clear of flexural stresses (e.g., careful storage, use of pipe supports, etc.).

Welding Joint Evaluation

The control of the welding joint quality on site should be performed only by certified personnel with proper knowledge of the welding technique. Different tests, according to DVS guidelines, may be performed:

- Visual test of the welding joint (DVS 2202-1)
- Tensile test for the determination of the short-term welding factor (DVS 2203, part 1)
- Bending test for the determination of the bending angle (DVS 2203, part 5)
- Pressure test on the installed pipeline, according to DVS 2210, part 1, supplement 2 (DIN 4279)

Flange

Flanging and AV Gaskets

When bolting a flange connection, it is required to tighten the bolts in a specified pattern and to a required specification. Asahi/America offers a line of low-torque AV gaskets in sizes 1/2"–12" for single wall pipe connections. These gaskets offer a unique double-convex ring design that gives optimum sealing with one-third the torque of a common flat gasket seal. The gaskets are available in the following materials:

- EPDM
- PVDF bonded over EPDM
- Teflon® over EPDM

They are available in both standard and high-purity grade. PTFE and PVDF bonded gaskets are produced in a proprietary laminating process for bonding to EPDM. The use of the rubber backing provides greater elasticity for lower bonding torques.

Detail of Gasket

When tightening a flange, the torque rating is dependent on the gasket used. For the AV gasket, see Table E-8 for the recommended tightness. In addition, follow the star pattern shown Figure E-33 when tightening. Conduct two or three passes, tightening the flange uniformly. Finish by doing a circular pass to check the torque values. Always use a torque wrench when tightening a flange. A common mistake when tightening a flange is to squeeze it as tightly as possible; however, this action will damage the gasket and eventually lead to reduced elasticity and leakage. Do not tighten beyond the rating.

E

See product data sheet.

Table E-8. Recommended Bolt Torque for AV Gaskets (lbs.)

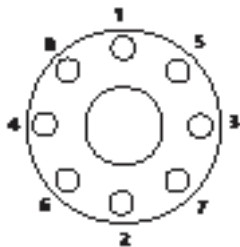

Figure E-33. Torque pattern

Butterfly Valves

Most Asahi/America piping systems are produced to metric dimensions according to ISO standards. However, Asahi/America butterfly valves are produced according to iron pipe size dimensions. The outcome is that in certain sizes, the disk of the butterfly valve can meet interference with the inside pipe wall when opening. The interference is typical in SDR11 polypropylene systems in 6" or larger and SDR32.5 polypropylene in 8" or larger. In PVDF systems, the effect is 8"–12" in SDR33 and 6" or larger in SDR 21 systems. Polypropylene stubs in the interfering dimensions are always beveled at the factory to avoid this issue. PVDF stub ends mounted for butterfly valve installation must be ordered special from Asahi/America. PVDF stubs are not automatically supplied with a beveled end for other reasons. Contact Asahi/America for special part numbers on PVDF beveled stub ends.

Flange Connections of Piping Systems

If pipe joints are connected by means of flanges, the following guidelines must be adhered to:

- Aligning of parts

Before applying initial stress on the screw, the sealing faces have to be on an aligned plane, parallel to each other, and fit tight to the sealing. Under any circumstances, the flange connection should not draw near to the occurring tensile stress.

- Tightening of screws

The length of the screws has to be chosen so that the screw thread possibly flushes with the nut. Washers have to be placed at the screw head and also at the nut. The connecting screws have to be screwed in with a torque key (for torque values see www.agru.at).

Generally, it is recommend to brush over the thread, (e.g., with molybdenum sulfide) so that the thread runs easily for a longer operation time. For the selection of sealing material, the chemical and thermal resistance has to be considered.

Adhesive Joints

Adhesive joints with polyolefines are not applicable. The achieved strength values range extremely below the minimum requirements for adhesive joints in practice.

Tri clamp

Tri clamps, otherwise known as sanitary fittings are a common form of mechanical joining of pipes in high purity applications. A typical tri clamp connection consists of two ferrules, a gasket with raised groove, and one of several types of clamps. The combined flange and gasket do not impede the flow of fluids though the pipe. The clamping system can be easily removed when using a fold-over hinged clamp. Plastic tri clamps are designed to allow connection to existing stainless steel, and sanitary systems. Please consult Asahi/America for additional information about thermoplastics for use in pharmaceutical.

Thread

In general, threaded connections are not recommended for high pressure thermoplastic piping systems. If thermoplastic pipe is threaded, the pressure rating is derated significantly. In certain instances, an installer may choose to thread the system. Recommendations for threading plastic piping have been developed by the

Plastic Piping Institute. It should be noted that certain Asahi/America systems with thinner walls simply cannot be threaded. In addition, metric pipe systems, even with thick pipe walls, cannot be threaded because the outside diameters are not the same as IPS pipe, making the threads too short in height.

Only pipe that has a wall thickness greater than Schedule 80 should be threaded. Only pipe dies that are clean, sharp, and specifically designed for plastic piping should be used. If a vise is used to restrain the pipe during the cutting, exercise caution to avoid scratching or deforming the pipe. Wooden plugs inserted in the pipe ends can reduce this risk.

Before cutting threads, the pipe must be deburred of all sharp edges. A die stock with a proper guide that will start and go on square to the pipe axis should be used. The use of cutting oil should be kept to a minimum. Once the threads are cut, they should be seated with PTFE tape.

E

In most cases, the use of threading pipe can be avoided altogether by the use of molded male and female adapters. These fittings have been designed and produced to provide a full 150 psi pressure rating at 21°C (70° F). The male and female adapters address the need to connect to existing pipe systems or equipment without derating the system. The use of these fittings welded to the pipe is recommended instead of attempting to thread pipe.

Asahi/America does not recommend threading or threaded fittings made of HDPE.

Weatherability/UV

Weather Effects

Polypropylene, HDPE, and PVDF are resistant to nearly every effect of weather. However, they differ on one important characteristic: resistance to ultraviolet light degradation. PVDF is almost completely unaffected by UV light. HDPE, with its black additive, is resistant to UV light, as is Poly-Flo® black polypropylene. Standard polypropylene from Asahi/America is a European gray polypropylene that is affected as the energy from ultraviolet radiation initiates a chemical reaction in the polymer. Natural polypropylene is not UV-resistant.

The reaction between polypropylene (gray) and UV radiation only takes place at the surface to shallow depths measured in minute fractions of an inch. The

molecules at the surface of the plastic are permanently altered to form a complex formation of various chemicals, such as polypropylene-type formations. A noticeable chalky-yellow appearance ensues, which results in a slight reduction in impact strength. This effect will only become noticeable upon prolonged exposure, and it will not continue to progress if the ultraviolet source is removed. The effect can be measured after a prolonged period of time as a slight increase in tensile strength, a slight increase in elastic modulus, and a minor decrease in impact strength. The degradation only occurs to a shallow depth, although in time the chemically altered surface molecules may slightly flake off. Thin-walled polypropylene pipe fittings should be protected against ultraviolet light penetration if placed in an outdoor environment. Some of the various methods include painting, providing a “shield,” or taping/wrapping the pipe. In order to paint the piping, polypropylene must first receive a coating of a suitable primer to allow the acrylic lacquer to be applied. The primer can be applied by brush to small diameter pipes and sprayed onto larger diameter pipes. Then, a suitable paint can be selected and applied in a similar fashion. It is advisable to strictly adhere to the manufacturer’s instructions concerning safe operating practices when applying the selected paint.

A thin-walled insulation-type shield or rigid vapor jacket barrier can eliminate the effects of ultraviolet light. A thin aluminum shield should provide all the protection that is necessary.

A third method includes covering the piping with tape. A recommended type of tape is called “TapeCoat” and is made by TapeCoat, Inc. of Evanston, IL. This tape should be applied with 50 percent overlap, and when properly applied, it will completely protect the piping against ultraviolet attack.

Chlorine and Chlorinated Hydrocarbon Installations

When PVDF is used to transport chlorine or chlorinated hydrocarbons, special precautions should be taken if the possibility of a reaction is suggested by the application. In certain post-chlorination pipe lines, downstream in a bleached paper process (chlorine dioxide reactor, for instance), there exists a small amount of spent reactants that ordinarily would not proceed to completion. However, it has been shown that ultraviolet light from sunlight or fluorescent light fixtures may offer enough energy to initiate this reaction to completion.

In the process, free-radical chlorine is released instantaneously, and there is a tendency for some substitution of chlorine molecules for hydrogen in the polymer chain. As this happens, stress cracks may appear in the pipe wall through a mechanism that is not yet completely understood, and the system may fail. Therefore, it is required to protect any PVDF system from the possibility of ultraviolet light propagation from reactions involving the generation of free-radical chlorine. One method of providing this protection is through the same method of taping described in the previous section for protecting polypropylene piping from ultraviolet attack.

Union

Unions of Piping Systems

If pipe joints made out of thermoplastics are connected by means of unions, the following regulations have to be adhered to:

- For avoiding impermissible loads at installation, unions with round sealing rings should be applied
- The union nut should be screwed manually or by means of a pipe band wrench (common pipe wrenches should not be used)
- Prevent the application of unions at areas with bending stresses in the piping systems

Tip: thread seal only with Teflon® do not use hemp

E

SPECIAL SYSTEM CONSIDERATIONS

Contents

High Purity	F-2
Industrial	F-6
Double Contained	F-9
Ventilation	F-10
Compressed Air	F-12

HIGH PURITY

High Purity System Design

A pure water system comprised of PVDF or polypropylene is similar to most chemical feed systems. The critical factor in a pure system is to design it in a continuous moving loop without dead-legs to avoid the possibility of microorganism growth.

Systems should also be sized to have turbulent flow as part of the method of inhibiting bacteria growth. PVDF and PP systems are ideally suited for pure water as they have extremely smooth inner surfaces that reduce particle generation and inhibit sites for bacteria to adhere to and proliferate. In addition, PVDF and PP systems have low extractables; therefore, the water being transported is not contaminated.

In designing a thermoplastic high purity water system, the following items need to be considered:

- Materials of construction
- Operating parameters
- System sizing
- Thermal expansion
- Minimizing dead-legs
- System monitoring
- Hanging
- Welding methods
- Other considerations

Materials of Construction

PVDF is the premier material for high purity water systems. PVDF has been used in ultrapure water systems for over 25 years because it is superior to materials such as stainless steel or PVC. PVDF combines excellent surface finish with low extractables to provide the highest quality piping material for the application. In addition to its purity attributes, PVDF is also available in a variety of components and welding methods that are well-suited for UPW applications. PVDF is a crystalline material that can withstand high pressures. However, the nature of PVDF requires special planning and handling during the installation. These types of requirements are now commonplace on the market and are accepted as standard operating methods. PVDF is recommended for the service of the strictest applications that require low bacteria counts and virtually undetectable levels of metal ions.

For applications less stringent in water quality level, polypropylene is an excellent alternative. PP offers excellent surface smoothness, as well as low extractable levels as compared to stainless steel. Polypropylene systems are thermally fused together, eliminating the use of glues, which will continue to leach into a water system for extended periods of time. PP is an extremely weldable material, making fusion joints simple and reliable. For more information on PP, consult Section B.

The third alternative is E-CTFE. This material, also known as Halar®, provides superior surface even compared to PVDF. Its extraction levels are also similar to those of PVDF. Halar® is a very ductile material, making its use and welding methods extremely reliable. E-CTFE is normally only available in certain sizes and does have some pressure limitations at higher temperature. Halar® has become the preferred material for tank lining applications.

Operating Parameters

Because thermoplastic systems have varying ratings at different temperatures, it is important to design a system around all of the parameters to which it will be subjected. As a first pass, verify the following operating parameters:

- Continuous operating temperature
- Continuous operating pressure
- Media and concentration

By knowing the above parameters, thermoplastic pipe systems can be selected. Compare the actual conditions to the allowable ratings of the material being selected for the job. It is important to predict elevated temperatures, as thermoplastics have reduced pressure ratings at higher temperatures. Valves should be verified separately from a piping system in terms of temperature and pressure, as certain styles and brands of valves have lower ratings than the pipe system. Finally, if the media is not water, a chemical compatibility check should be conducted with the manufacturer.

After verifying the standard operating conditions, it is necessary to examine other operations that might affect the piping. The following is a sample of items to investigate prior to specifying a material.

- Will there be spikes in temperature or pressure?
- Is there a cleaning operation that the piping will be exposed to?

- If yes, what is the cleaning agent? What temperature will the cleaning be conducted at?
- Will the system be exposed to sunlight or other sources of UV?

Each of the above questions should be answered, and the desired material should be checked for suitability based on the above factors, as well as any others that might be unique to the system in question.

System Sizing

It is well-known that high purity water systems are designed to operate in a continuously flowing loop to prevent stagnant water in the system. Stagnant water can proliferate the growth of bacteria and bio-film. The pattern and design of the loop will vary depending on the facility requirements.

The flow rate in the system is important for determining the pipe diameter size. In a pure water system, elevating flow velocities is recommended to reduce the possibility of bioadhesion to the pipe wall or welded surfaces.

Many specifications will state that the flow should be set at a minimum of five feet per second, which will always be a turbulent flow at this velocity. However, a more sensible approach may be to review the Reynolds Number of the system to ensure that the flow is turbulent. Use of the Reynolds Number may reduce waste caused by the oversizing of pumps to overcome excessive pressure drops due to unnecessarily high velocities.

Because many HP systems are now produced from high-quality Purad® PVDF, high velocities in a continuously flowing system may not be as necessary. High velocities are generally accomplished by undersizing the pipe diameter, which is directly proportional to increased pressure drops. In fact, high minimum velocities are detrimental to the ability of a system to deliver adequate point-of-use pressure during peak demand conditions. Therefore, using cleaner, smoother material such as PVDF is desirable for design and operation.

Sizing Laterals

A pure water system and an ultra pure water system will be made of main loop branches known as laterals. It is important in design to not dead-end laterals and ensure there is always flow movement in the main and in the lateral. Systems are designed with different loop

configurations to accommodate the needs of production. However, all laterals must be designed for continuous flow and should feed unused water back into the return line.

For supply laterals feeding multiple tools, the lateral needs to be sized based on an acceptable pressure drop. A general rule of thumb is two psig per 100 feet. Consideration of point-of-use water consumption, length, and frequency of demand must be factored into the sizing process of the lateral.

Sizing Mains

Main trunk lines are sized using the demand for water by the tools plus the tool and return lateral minimum flows. Tool demand can be calculated by taking the average flow demand and multiplying it by 1.2 to 1.8 to accommodate for peak demand. This should be based on the tool manufacturer's parameters.

The return lines should be sized for minimal pressure drop when the tool demand is at a minimum, which will correspond to maximum bypass at the end of a main pressure control station.

Thermal Expansion

Typically, Purad® and PolyPure® systems are designed for ambient or cold DI water. In these cases, because the systems operate continuously and are normally inside a fairly constant temperature building, the need to compensate for thermal expansion is not required. Although, it is an important factor that should be reviewed on each and every installation design.

Hot DI systems that normally operate at temperatures of 150°F to 248°F (65°C to 120°C), depending on the water usage, require a more complex design. PVDF systems can be used in hot water applications and applications where the temperature is cyclical. These systems require analysis of the thermal expansion effects. In most cases, the use of expansions, offsets, and proper hanging techniques is all that is required to ensure a proper design.

Hot DI systems also reduce the rigidity of thermoplastic piping systems, which, in turn, decreases the support spacing between pipe hangers. In smaller dimensions, it is recommended to use continuous support made of some type of channel or split plastic pipe.

Finally, the use of hangers as guides and anchors becomes important. Certain hangers should be used

as guides to allow the pipe to move back and forth in-line, while other hangers should be anchoring locations used to direct the expansion into the compensating device. The anchors and hangers should be designed to withstand the end load generated by the thermal expansion.

Minimize Dead-Legs

The term dead-leg refers to a stagnant zone of water in the system. Dead-legs are normally formed in the branch of a tee that is closed off with a valve. See Figure F-1.

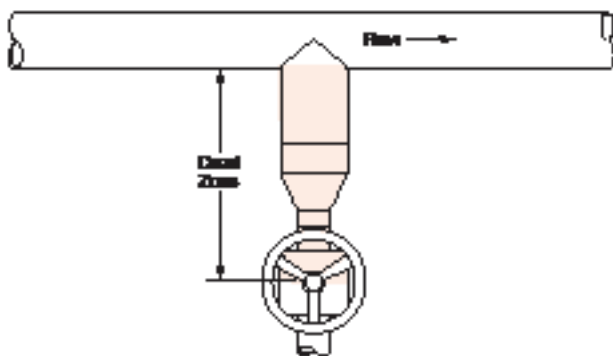

Figure F-1. Dead-legs due to poor design

F A rule of thumb in designing a system is to keep all dead-legs to a maximum of six internal pipe diameters in length. The turbulent flow in the main trunk line will create a significant amount of movement to keep the leg moving and prevent bacteria from adhering to the pipe wall. However, the Purad® system allows designers to avoid dead-legs altogether with the advent of T-diaphragm valves and zero dead-leg fittings.

T-valves (see Figure F-2) take the place of a tee, reducer, and diaphragm valve by combining all three into one component. T-valves reduce the quantity of welds in a system as well. By using a T-valve, branch lines can be shut off at any time without creating a dead leg and turned back on without an extensive flush procedure.

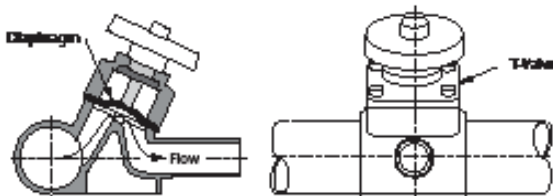

Figure F-2. T-valve eliminates dead-leg

Dead legs in a system can be found in more than

just branch lines. Often, the introduction of a gauge, measurement device, and/or sampling valve can create a dead leg. Because it is not recommended to tap into the side of a PVDF pipe for safety reasons, gauges are installed using tees and caps, as shown in Figure F-3.

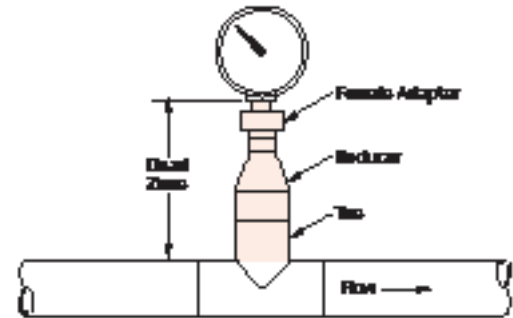

Figure F-3. Dead-leg due to improper instrument installation

Because these tee configurations are narrow in diameter, they create a dead-leg in the branch where microorganism growth can be initiated. The use of instrumentation fittings eliminates dead legs while acting as a safe adapter for gauges or sample valves. See Figure F-4.

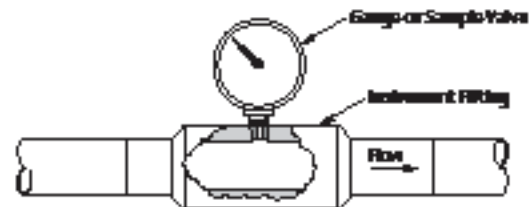

Figure F-4. Proper use of instrument fitting to avoid dead space. Can be used with gauge guard.

The insertion of a resistivity probe can also be a possible source for dead legs. Because most probe manufacturers recommend that fluid flows directly at the probe, they are often situated in the leg of a tee, and the tee acts as a 90° elbow. Because most probes are supplied as a 3/4" NPT fitting or sanitary adapter, there is the necessity to weld reducers onto the tee leg to accommodate the sensor, which will create a dead zone. A simple fitting, the probe adapter conveniently eliminates the need for reducers and shortens the leg of the tee. See Figure D-5. Probe adapters are available in

all sizes and pressure ratings.

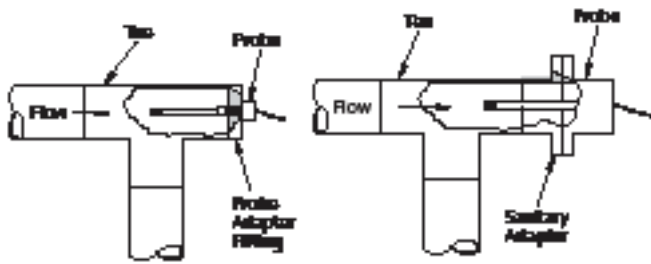

Figure F-5. Proper adapter setups

High Purity Installation

Installing a high purity system properly requires preplanning. The installation is more than the welding of components. It requires the proper environment, material inventory, welding equipment, tools, and thorough training.

General rules on installation

- The quality level of the materials should be maintained from delivery to the finished project.
- No smoking or eating is allowed during working time.
- There should be incoming control of material and marking of quality level according to the user's standards of marking and labeling.
- Do not touch the inner surface of any kind of pipe component, not even in gloves.

Welding environment

Asahi/America does not set requirements for proper welding environments. As the installer, it is necessary to choose the environment based on the installation type, timing, or quality goal. In all cases, the environment for welding should be monitored to ensure that the temperature is in the range of 41°F to 105°F (5°C to 40°C). The humidity should not exceed 70 percent. If using IR fusion, wind must be avoided.

All Purad[®], PP-Pure[®], and PolyPure[®] components are manufactured and packaged in a clean room environment. Great care is taken to ensure that they arrive on the project site in protective packaging to maintain their purity. To be consistent, it is ideal to conduct welds in a clean or clean room environment. Particles, dust, or dirt in the air will adhere to the pipe during the welding process. To reduce contamination in the system, as many welds as possible should be

conducted in a clean environment. A class ISO 5 or ISO 6 room is perfectly suitable. Portable style clean rooms make for an efficient set-up when conducting all of the welds on site.

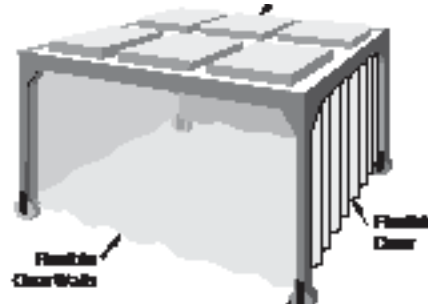

Figure F-6. Portable cleanroom

Within the clean zone, it is recommended to build spool pieces. The size and configuration is dependent on the ability to safely transport it to its final destination. The ends of the spool pieces should be prepared for final connection once in the pipe rack. In smaller dimensions, OD 20mm to OD 63mm (1/2"–2"), the ends should be fitted with unions or sanitary fittings to reduce welds in the pipe rack, as they are more difficult.

In sizes larger than OD 63mm (2"), it is recommended to build spool pieces with flange connections. Doing this avoids having to conduct difficult fusion welds in tight locations. Flanged spool pieces also offer the benefit of being able to make changes later.

If welding in a clean room or clean environment, remove the outer bag in a staging area, and store the fitting inside the clean room in the single bag until ready for use. It is recommended to store the fittings in plastic bins within the clean room instead of using a cardboard box within a clean environment. Label bins by size and fitting style.

PolyPure[®] fittings should be left in their bag and brought into the clean zone as is. If for some reason the outside of the bag is contaminated, it should be wiped down with IPA prior to entering the clean zone. Valves should be handled in the same manner.

When ready to transport the pipe into the clean zone, open the outer cap on the HDPE protection tube of the PVDF UHP pipes. Place the tube next to the clean zone entry, and slide the pipe directly from the tube into the clean room. This will eliminate the need to wipe down the bag prior to entry. In the clean room, remove the

single bag if ready for immediate usage. If stored in the clean environment, it is preferred to leave the pipe in its original packaging.

Place the double bagged PP-Pure® pipe next to the clean zone entry. Open the second bag, and slide the single bagged pipe into the clean room. Remove the single bag if ready for immediate usage.

PolyPure® pipes can remain in their shipping packaging until ready for use or transported into the fabrication clean room.

When ready for welding, remove all packaging and caps. Remember to save the caps for sealing the ends of prefabricated spool pieces.

Training

An ultra pure water or chemical system is a critical utility within a plant's operation. An unplanned shutdown can prove to be more costly than the water piping construction itself. One bad weld can cause hours of repair and frustration, as well as significant loss of revenue. For these reasons, it is critical to receive training at the time of job start-up and to use certified personnel throughout the course of a project. Tool operation is only one of several factors in a thorough training course. Operators, inspectors, and managers need to understand the physical nature of the material: how to properly handle it, how to inspect welds, how to identify potential problems, how to properly maintain equipment, and finally, how best to tie into a line and test it.

All of the above topics are discussed during AGRU's certified training sessions. For the installation of a high-purity system, the following training sessions are available:

- Tool operator training and certification
- Quality control inspection

INDUSTRIAL

Single Wall Chemical Pipe System Design

When properly designing a single wall pipe system for the transport of chemicals, several factors need to be reviewed.

A properly designed thermoplastic system will provide years of reliable service without the headaches of

corrosion problems.

At the time of design, consider and plan for the following items:

- Materials of construction
- Thermal expansion
- System sizing
- UV considerations
- Insulation
- Hanging
- Welding methods

Materials of Construction

The first and foremost item in any system design (metal or thermoplastic) is the media that will be running through the pipes and parameters of operation. Using accurate data for the system design will transfer to years of reliable operation. When considering the system design, answer the following questions:

- What is/are the chemical(s) to be in contact with the system?
- What are the chemical concentrations?
- What temperature will the system operate at?
- What pressure will the system operate at?
- What is the flow of the media in the system?

By answering these questions, the proper material of construction can be selected for the project. To assist in the material selection, refer to the chemical resistance tables on our web site. A thermoplastic system's ratings for temperature and pressure are based on water. The addition of certain chemicals will add stress to the system and may reduce the recommended operating parameters. For less aggressive chemicals, the resistance tables on our web site are perfectly suitable. For more aggressive chemicals or mixtures of chemicals, the manufacturer of the pipe system should be consulted.

After verifying the standard operating conditions, it is necessary to examine other operations that might affect the piping. The following is a sample of items to investigate prior to specifying a material.

- Will there be spikes in temperature or pressure?
- Is there a cleaning operation that the piping will be exposed to?
- If yes, what is the cleaning agent? What temperature will the cleaning be conducted at?
- Will the system be exposed to sunlight or other

sources of UV?

Each of these questions should be answered and the desired material should be checked for suitability based on these factors, as well as any others that might be special to the system in question.

Finally, in addition to verifying the temperature, pressure, and media with the thermoplastic pipe material, it is also necessary to verify other components in the system, such as valves, gaskets, valve seat and seals, etc. These should be examined in the same manner as the pipe material.

Thermal Expansion

Based on your operating criteria, thermal expansion must be considered. For systems maintained at consistent temperatures, compensation for thermal effects may not be required. It is, however, important to review all aspects such as the operating environment. Is it outdoors where it will be exposed to changing weather? Is the system spiked with a high temperature cleaning solution? Will the system run at a significantly higher temperature than the installation temperature? The occurrence of any thermal change in a plastic system will cause the material to expand or contract. As an example of the effect, polypropylene will grow roughly one inch for every 100 linear feet and $10 \Delta T$.

Thermoplastic systems can be used in hot applications and applications where the temperature is cyclical; it just requires analysis of the thermal expansion effects. Section C walks through the steps of calculating thermal expansion, end loads, and expansion compensating devices. In most cases, the use of expansions, offsets, and proper hanging techniques are all that is required to ensure a proper design.

Hot systems also reduce the rigidity of thermoplastic piping, which, in turn, decreases the support spacing between pipe hangers. In smaller dimensions, it is recommended to use continuous support made of some type channel or split plastic pipe.

Finally, the use of hangers as guides and anchors becomes important. As the design procedures in Section C indicates, certain hangers should be used as guides to allow the pipe to move back and forth in-line, while other hangers should be anchoring locations used to direct the expansion into the compensating device. The anchors and hangers should be designed to withstand

the end load generated by the thermal expansion. Figure F-7 is an example of an anchor type restraint fitting that is available from Asahi/America.

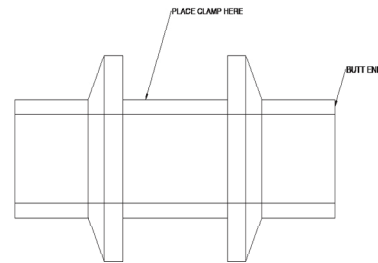

Figure F-7. Restraint fitting

For calculation of allowed stresses and design of expansion compensation devices, refer to Section C, Engineering Theory and Design Considerations.

System Sizing

In Section C, there is a detailed discussion on fluid dynamics and determination of flow rates and pressure drops. When using any thermoplastic with a hazardous chemical, it is recommended to maintain flow rates below a velocity of 5 ft/second. High velocities can lead to water hammer in the event of an air pocket in the system. Water hammer can generate excessive pressures that can damage a system. For safety reasons, high velocities should be avoided.

In addition, high velocities also mean added pressure drop, which, in turn, increases demand on the pump. If the flow velocity is not required, it is recommended to size a system with minimal pressure drop. It is also recommended to oversize a design to allow for future expansion or chemical demand. Once a system is in place, it is difficult to add capacity to it.

UV Considerations

All thermoplastic materials react to the exposure of UV differently. PVDF and E-CTFE materials are almost completely UV-resistant over the course of its design life. However, certain chemicals containing Cl anions exposed to UV light can create a free-radical Cl, which will attack the PVDF pipe wall. For more information on these chemicals, refer to UV Exposure and Weatherability later in this section.

Polypropylene is not UV stable. In direct exposure to sunlight it will break down. The effect can be seen in a

noticeable color change in the pipe. In a pigmented PP system, the color change will actually create a protective shield on the outer layer of the pipe and prevent further degradation. For PP pipes with a wall thickness greater than 0.25", the effect of UV is reduced and can be used outside. However, it is still recommended to protect it from UV exposure for added safety. Natural PP will not self create a UV shield as the pigmented PP does; therefore, UV protection is required all the time on natural PP systems.

Other materials, such as HDPE, may or may not be UV stabilized. PE containing carbon black are generally UV stable and can handle direct exposure. Other HDPE materials may require protection. Use of protection should be based on the individual grade of the polyethylene. Consult the manufacturer for details.

Insulation

Insulation is a good method of protecting a pipe system from UV exposure, as well as providing required insulation for the system or media being transported. A serious difference between plastic and metal is plastic's thermal properties. A metal pipe system will quickly take the temperature of the media being transported. A system carrying a media at 150° F (65°C) will have an outer wall temperature close to or at 150° F (65°C). In contrast, thermoplastics have an inherent insulating property that maintains heat inside the pipe better than a metal system. The advantage is that a plastic pipe has better thermal properties, which translates into improved operating efficiencies and reduced insulation thickness.

Hanging

See Section C for hanging details and proper placement distances. Since plastic reacts differently than metal, varying hanger styles are required. The designer of a system should specify the exact hanger and location and not leave this portion up to the installer.

Welding Methods

The system designer should specify the welding method to be used in any given project. Asahi/America offers several choices for joining PVDF and PP together. The choice of a particular method should be based on the following concerns:

- Installation location
- Size range

- System complexity

PVDF can be installed using butt fusion, IR fusion, socket fusion, and beadless HPF fusion. All methods are proven in chemical systems and each has its own advantages. Polypropylene is weldable using butt, IR, or socket fusion. In addition, Asahi/America offers electrofusion couplings for PP that are ideal for repairs. (Electrofusion PP couplings may have reduced chemical resistance. Consult factory.) E-CTFE can be welded using butt or IR fusion. It is recommended to assemble Halar® with IR fusion, as special heating elements are required for welding Halar® with conventional butt fusion equipment.

Socket fusion is ideal for small, simple, low-cost systems. In small diameters, 1/2"–1-1/4" socket fusion can be done quite easily with a hand-held welding plate and a few inserts. With just a limited amount of practice, an installer can make safe and reliable joints. For larger dimensions, up to a maximum of 4", bench-style socket fusion equipment is available for keeping joints aligned.

For systems that have larger dimensions above 4", butt and IR fusion make a logical choice. Butt fusion is available in every pipe size made available by Asahi/America. Welding can take place in a variety of climates and conditions. In addition, butt fusion offers the widest variety of welding equipment options. Tools are available for bench welding, trench welding, and welding in the rack, making it completely versatile for almost all applications. Refer to Section F for guidance in tool selection.

IR fusion is available for welding 1/2" to 10". IR is an extension of the butt fusion method. The operation is the same with the exception that material being joined is not in contact with the heat source. Rather, the material is brought in close to the heating element and the heat radiates off to the components. The advantage of this method for chemical systems is the elimination of molten material sticking to the heat source. IR fusion is better suited for indoor applications. IR fusion equipment is highly sophisticated, providing the operator with detailed information on the weld process and quality. For critical applications with dangerous media, IR fusion may be best suited due to the quality assurance built into each piece of equipment.

DOUBLE CONTAINED

Design of the Double Containment Piping System

Installation System

In comparison with the installation of a single pipe, there are possible changes in length in the installation of the double containment piping system that are due to thermal expansion or contraction, and they require special attention. The temperature changes of the inside and outside pipes can be different or even opposite based on the distance between the pipes. This can lead to considerable length expansions between the pipes. If it cannot be detected, constructive stress will be developed, which is an additional demand on the pipe lines. One can distinguish between three different design systems: fixed, flexible, and impeded.

Fixed System

The inside, outside, and surrounding area of the pipe are fixed together by dog bones on each directional change. A length expansion of the inside or outside pipe is not possible.

Advantages:

- Low expenses
- Little area needed

Disadvantages:

- High Dogbone™ forces (note the fixing demand)

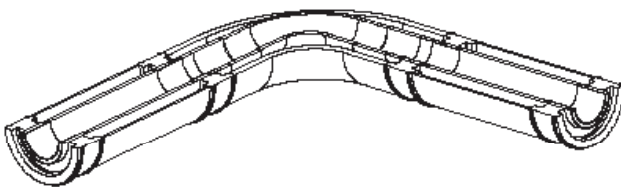

Figure F-8. Fixed system design

Unimpeded Heat Expansion (flexible system)

The inside and outside pipes are installed so that a length expansion from both pipes, and even among each other, can happen. In terms of the planning, it needs to be considered that the length expansion of the inside pipe takes place in the outside pipe.

Advantages:

- Applicable for higher operating temperatures
- Low stress of the double containment piping system because of free expansion

Disadvantages:

- Higher expenses
- Often need large area because of the compensation elbow

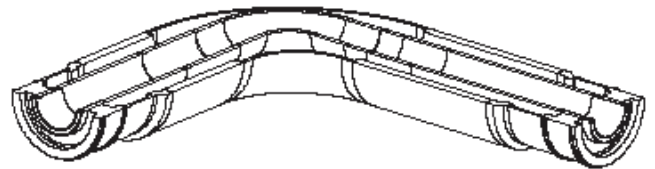

Figure F-9. Unimpeded heat expansion design

System with Impeded Heat Expansion

The inside and outside pipes are fixed together by dog bones. The length expansion of the whole double containment pipe line will be picked up through sufficient measures (compensator, straight). This method is only sensible when the inside and outside pipes are made out of the same material and few temperature changes occur between the inside and outside pipes.

Advantages:

- Low expenses
- Usually low fixing expenses

Disadvantages:

- High stress in the double containment piping system
- Often need large area because of the compensation elbow

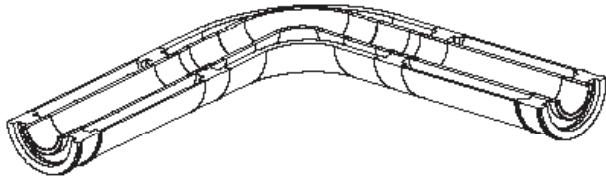

Figure F-10. Impeded heat expansion design

VENTILATION

Ventilation System Design

Thermoplastic materials have begun to be used for ventilation applications. A thermoplastic vent system provides many features that standard sheet metal cannot in terms of functionality, ease of installation, and corrosion resistance.

In designing a thermoplastic water system, the following items need to be considered:

- Materials of construction
- Operating parameters
- Codes
- Layout recommendations
- Thermal expansion
- UV exposure
- Hanging
- Welding methods

Materials of Construction

For the construction of ventilation systems, Asahi/America provides the ProVent® system. ProVent® components are available in polypropylene (ProVent®) and PVDF (PuradVent®). The system is designed specifically for the ventilation and transport of hazardous fumes and potentially corrosive gases. Both polypropylene and PVDF offer different resistance to chemical applications that should be verified prior to purchase.

Operating Parameters

The ProVent® system is available in multiple wall thicknesses in polypropylene. The selection of a material pressure rating should be based on the following criteria:

- Operating temperature
- Media to be transported
- Operating pressure, positive or negative
- Economics
- Required fire codes
- Size to be installed

By evaluating the previous parameters, the proper system can be chosen. In many applications, polypropylene will more than exceed the needs of the system; however, if the media to be transported is at an elevated temperature, PVDF may be required.

In general, PP systems are available in a larger selection of sizes and pressure rating options. Refer to Asahi/America's ProVent® Dimensional Guide for the availability of components.

Codes

For designing a ventilation system, the most pertinent code is probably the fire code or the need for Factory Mutual (FM) approval. ProVent® systems made of polypropylene can be installed according to FM regulations, and the final installed product will meet FM requirements. The use of PP in systems requiring FM approval will require the use of an internal sprinkler head system. In case of a fire, the sprinkler system would eliminate the possibility of the vent system spreading the fire.

There are sprinkler systems on the market that are specifically designed for this application, and they dramatically reduce the installation labor, as well as the required sprinkler head inspection process after installation. Figure F-11 shows details of a typical flexible sprinkler head and the mounting component offered by Asahi/America.

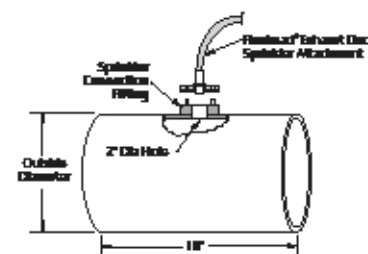

Figure F-11. Detail of a flexible sprinkler head and mounting component

PuradVent® PVDF is a material that is considered self-extinguishing. PVDF has significantly better smoke and

flame ratings than most other thermoplastic materials. PVDF material offered by Asahi/America is an FM approved material, according to FM 4910 Standards.

Contact Asahi/America for further information on installation requirements for PVDF systems. In addition, Asahi/America has the test results on file for multiple smoke and flame standards for both polypropylene and PVDF.

In short, there may be a need or requirement for internal closed-head sprinklers in a ProVent® system if combustible materials can accumulate inside the pipe line.

Layout Recommendations

Ventilation systems are often the most custom designed of any pipe system in the factory. They are large in diameter and generally need to be connected to multiple equipment vents. Asahi/America offers a wide range of standard components for assembling a system.

However, many systems cannot be accomplished using standard components. A skilled installer can make special fabrications in the field to accomplish the layout requirement of a system. In addition, Asahi/America can design and prefabricate pipe systems and ship them ready for installation. Figure F-12 shows details of a component that could not be made with standard fittings but can easily be produced in Asahi/America’s fabrication shop and shipped to the job site ready to be installed.

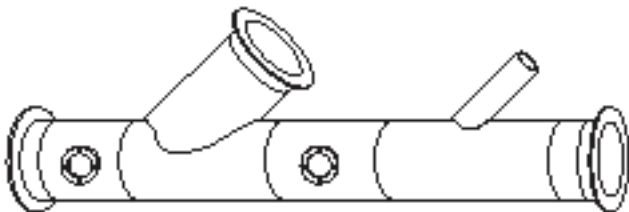

Figure F-12. Asahi/America prefabricated assembly

For more information on fabrication assistance, contact Asahi/America’s Engineering Department.

Thermal Expansion

Based on a system’s operating criteria, thermal expansion must be considered. For systems maintained at consistent temperatures, compensation for thermal effects may not be required. However, it is important to review all aspects of the operating environment. Certain questions should be considered, such as:

- Is the system outdoors where it will be exposed to changing weather?
- Is the system spiked with a high-temperature cleaning solution?
- Will the system run at a significantly higher temperature than the installation temperature?

The occurrence of any thermal change in a plastic system will cause the material to expand or contract. As an example of the effect, polypropylene will grow roughly one inch for every 100 linear feet at 10° F ΔT.

Ventilation systems will often reach an equilibrium with the temperature of the ambient environment. Therefore, if the pipe is hung in a ceiling where the temperature will vary in the summer and winter, the change in temperature that most affects the pipe may be due to the ambient temperature change rather than media temperature change. This is almost always the case in systems installed outdoors.

ProVent® systems can be used in hot applications and in applications where the temperature is cyclical; it just requires analysis of the thermal expansion effects. In most cases, the use of expansions, offsets, and proper hanging techniques is all that is required to ensure a proper design.

Hot systems also reduce the rigidity of thermoplastic piping, which, in turn, decreases the support spacing between pipe hangers. In smaller dimensions, it is recommended to use continuous support made of some type of channel or split plastic pipe. Review hanging requirements that are based on the actual operating temperatures.

Finally, the use of hangers as guides and anchors becomes important. Certain hangers should be used as guides to allow the pipe to move back and forth in-line, while other hangers should be anchoring locations used to direct the expansion into the compensating device. The anchors and hangers should be designed to withstand the end-load generated by the thermal expansion.



UV Exposure

As a rule, PVDF material is UV resistant and can be installed in direct exposure to sunlight without protection. In certain applications with chlorine content, this may not be true. Free-radical chlorine can cause a breakdown of PVDF when exposed to UV light. For these applications, it is best to protect the pipe by wrapping or insulating it. Contact Asahi/America for information on chemicals that can cause this effect.

Polypropylene is not 100 percent UV stable. Over time, the outer surface of a standard gray polypropylene pipe will change color and become brittle. The surface becomes chalky to the touch. Generally, if the surface is left untouched, the effect of the UV change will stop and not continue through the pipe. A pipe with a heavy wall thickness may not require protection, as the change will only occur on the outermost surface. The effect on the mechanical strength of the pipe will be minimal. However, most ventilation systems operate at low pressures and use thin-walled pipe for cost savings. Therefore, the ProVent® PP, in most cases, should be wrapped or protected from UV exposure.

Hanging

Because plastic reacts differently than metal, varying hanger styles are required. The designer of a system should specify the exact hanger and location instead of leaving this portion up to the installer.

Consult Asahi/America's Engineering Department for the hanging distance required on ProVent® systems.

Welding Methods

There are several options for installing a ProVent® system. Many projects will incorporate two or three different joining techniques.

The methods are:

- Conventional butt fusion
- Hot air welding
- Extrusion welding

ProVent® is made to the same outer wall dimensions (DIN Standards) as all other polypropylene and PVDF pipe systems offered by Asahi/America. The same butt fusion equipment and methodology can be used to assemble these systems. Butt fusion provides full pressure rated welds and offers a high degree of reliability for ventilation welding. However, depending

on the size of pipe and location of the welds, butt fusion can be cumbersome. Conducting a weld in a ceiling of 24" pipe will be difficult and will consume a significant amount of time to lift the pipe, the tool, and an operator into position.

In many cases, it is recommended to prefabricate a system on the ground or in a workshop and then conduct final assembly using flange connections. In addition to using flange connections for final hook-up, couplings and slip flanges can be used. These components can be hot air welded or extrusion welded, depending on the size of the pipe and the required system operating pressure.

Hand welding (hot air or extrusion welding) is a convenient method for welding in place or in prefabrication. The following is a detail of a slip coupling being hand welded. This method, while convenient, is highly reliant on an operator's skill. Hot air welding is simple and requires minimal practice to become proficient; however, extrusion welding is more complicated, and a more extensive training course is required. Once these skills are mastered, they will prove highly useful during installation. It is recommended on all ProVent® projects to buy at least one hot air welding tool, as there is always a need for it.

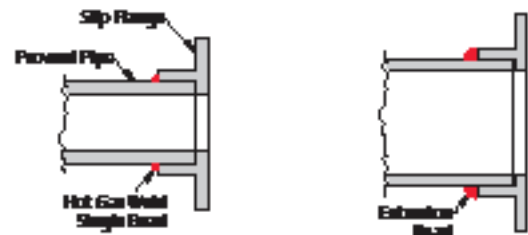

Figure F-13. Weld option

COMPRESSED AIR

Compressed Air System Design

See Air-Pro® product guide on www.asahi-america.com

DESIGN & PRESSURE TESTING

Contents

Single Contained	G-2
Double Contained	G-6

SINGLE CONTAINED

Single Wall Chemical Pipe

System Design

When properly designing a single wall pipe system for the transport of chemicals, several factors need to be reviewed. A properly designed thermoplastic system will provide years of reliable service without the headaches of corrosion problems. At the time of design, consider and plan for the following items:

- Materials of construction
- Thermal expansion
- System sizing
- UV considerations
- Insulation
- Hanging
- Welding methods

Materials of Construction

The first and foremost item in any system design (metal or thermoplastic) is the media that will be running through the pipes and parameters of operation. Using accurate data for the system design will transfer to years of reliable operation. When considering the system design, answer the following questions:

- What chemical(s) will be in contact with the system?
- What are the chemical concentrations?
- At what temperature will the system operate?
- At what pressure will the system operate?
- What is the flow of the media in the system?

By answering these questions, the proper material of construction can be selected for the project. A thermoplastic system's ratings for temperature and pressure are based on water. The addition of certain chemicals will add stress to the system and may reduce the recommended operating parameters. For less aggressive chemicals, use the printed resistance tables available on our web site. For more aggressive chemicals or mixtures of chemicals, the manufacturer of the pipe system should be consulted.

After verifying the standard operating conditions, it is necessary to examine other operations that might affect the piping. The following is a sample of questions to investigate prior to specifying a material.

- Will there be spikes in temperature or pressure?

- Is there a cleaning operation that the piping will be exposed to?
- If yes, what is the cleaning agent? At what temperature will the cleaning be conducted?
- Will the system be exposed to sunlight or other sources of UV?

Each of these questions should be answered, and the desired material should be checked for suitability based on these factors as well as any others that might be unique to the system in question.

Finally, in addition to verifying the temperature, pressure, and media within the thermoplastic pipe material, it is also necessary to verify other components in the system, such as valves, gaskets, valve seat and seals, etc. These should be examined in the same manner as the pipe material.

Thermal Expansion

Based on your operating criteria, thermal expansion may need to be considered. For systems maintained at consistent temperatures, compensation for thermal effects may not be required. However, it is important to review all aspects of the operating environment, such as:

- Is it outdoors where the pipe will be exposed to changing weather?
- Is the system spiked with a high temperature cleaning solution?
- Will the system run at a significantly higher temperature than the installation temperature?

The occurrence of any thermal change in a plastic system will cause the material to expand or contract. As an example of the effect, polypropylene will grow roughly one inch for every 100 linear feet and 10 ΔT .

Thermoplastic systems can be used in hot applications and applications where the temperature is cyclical; it just requires analysis of the thermal expansion effects. In most cases, the use of expansions, offsets, and proper hanging techniques is all that is required to ensure a proper design.

Hot systems also reduce the rigidity of thermoplastic piping, which, in turn, decreases the support spacing between pipe hangers. In smaller dimensions, using continuous supports made of some type of channel or split plastic pipe is recommended.

G

Finally, the use of hangers as guides and anchors becomes important. Certain hangers should be used as guides to allow the pipe to move back and forth in-line, while other hangers should be anchoring locations used to direct the expansion into the compensating device. The anchors and hangers should be designed to withstand the thermal end load generated by the thermal expansion. Figure G-1 is an example of an anchor type restraint fitting that is available from Asahi/America.

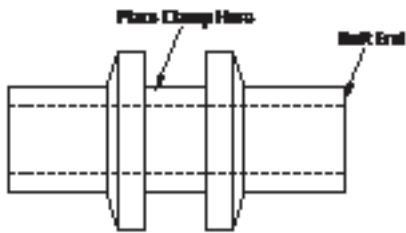

Figure G-1. Restraint fitting

System Sizing

When using any thermoplastic with a hazardous chemical, it is recommended to maintain flow rates below a velocity of 5 feet/second. High velocities can lead to water hammer in the event of an air pocket in the system. Water hammer can generate excessive pressures that can damage a system. For safety reasons, high velocities should be avoided.

In addition, high velocities also mean added pressure drop, which, in turn, increases demand on the pump. If the flow velocity is not required, it is recommended to size a system with minimal pressure drop. It is also recommended to oversize a design to allow for future expansion or chemical demand. Once a system is in place, it is difficult to add capacity to it.

UV Considerations

All thermoplastic materials react to the exposure of UV differently. PVDF and E-CTFE materials are almost completely UV resistant over the course of their design life. However, certain chemicals containing Cl anions exposed to UV light can create a free radical Cl, which will attack the PVDF pipe wall.

Polypropylene is not UV stable. In direct exposure to sunlight, it will break down. The effect can be seen in a noticeable color change in the pipe. In a pigmented PP system, the color change will actually create a protective shield on the outer layer of the pipe and prevent further degradation. For PP pipes with a wall thickness greater

than 1/4", the effect of UV is reduced, so they can be used outside. However, it is still recommended to protect the pipes from UV exposure for added safety. Natural PP will not self-create a UV shield as the pigment PP does; therefore, UV protection is required all the time on natural PP systems.

Other materials, such as HDPE, may or may not be UV stabilized. PE containing carbon black is generally UV stable and can handle direct exposure. Other HDPE materials may require protection. Use of protection should be based on the individual grade of the polyethylene. Consult the manufacturer for details.

Insulation

Insulation is an effective method of protecting a pipe system from UV exposure, as well as providing required insulation for the system or media being transported. A serious difference between plastic and metal is plastic's thermal properties. A metal pipe system will quickly take the temperature of the media being transported. A system carrying a media at 150°F (66°C) will have an outer wall temperature close to or at 150°F (66°C). In contrast, thermoplastics have an inherent insulating property that maintains heat inside the pipe better than a metal system. The advantage is that a plastic pipe has better thermal properties, which translates into improved operating efficiencies and reduced insulation thickness.

Hanging

Because plastic reacts differently than metal, varying hanger styles are required. The designer of a system should specify the exact hanger and location instead of leaving this portion up to the installer.

Welding Methods

The system designer should specify the welding method to be used in any given project. Asahi/America offers several choices for joining PVDF and PP together. The choice of a particular method should be based on the following concerns:

- Installation location
- Size range
- System complexity

PVDF can be installed using butt fusion, IR fusion, socket fusion, and beadless HPF fusion. All methods are proven in chemical systems, and each has its own advantages. Polypropylene is weldable using butt, IR, or socket fusion. In addition, Asahi/America offers electrofusion couplings for PP that are ideal for repairs.

(Electrofusion PP couplings may have reduced chemical resistance. Consult factory.) E-CTFE can be welded using butt or IR fusion. It is recommended to assemble Halar® with IR fusion, as special heating elements are required for welding Halar® with conventional butt fusion equipment.

Socket fusion is ideal for small, simple, low-cost systems. In small diameters, 1/2" - 1-1/4" socket fusion can be done quite easily with a hand-held welding plate and a few inserts. With just a limited amount of practice, an installer can make safe and reliable joints. For larger dimensions, up to a maximum of 4", bench-style socket fusion equipment is available for keeping joints aligned.

For systems that have dimensions above 4", butt and IR fusion make a logical choice. Butt fusion is available in every pipe size made available by Asahi/America. Welding can take place in a variety of climates and conditions. In addition, butt fusion offers the widest variety of welding equipment options. Tools are available for bench welding, trench welding, and welding in the rack, making it completely versatile for almost all applications.

IR fusion is available for welding 1/2" to 10". IR is an extension of the butt fusion method. The operation is the same with the exception that the material being joined is not in contact with the heat source. Rather, the material is brought in close to the heating element, and the heat radiates off to the components. The advantage of this method for chemical systems is the elimination of molten material sticking to the heat source.

IR fusion is better suited for indoor applications. IR fusion equipment is highly sophisticated, providing the operator with detailed information on the weld process and quality. For critical applications with dangerous media, IR fusion may be best suited due to the quality assurance built into each piece of equipment.

Burial Practices for Single Wall Piping

When designing the underground burial of thermoplastic piping, both static earth loads and live loads from traffic must be taken into account. The static load is the weight of the column of soil on the piping. The actual static load that the pipe is subjected to is dependent on many factors: the type of soil, the compaction of the soil, the width and detail of the trench, and the depth that the pipe is buried. The deeper the burial, the higher the load.

Burial of Single Wall Piping

Live loads decrease radially from the point at the surface from which they are applied. Live loads will have little effect on piping systems except at shallow depths. Polypropylene, polyethylene, and PVDF are flexible conduits. According to a basic rule of thumb, at least two percent of deflection can be achieved without any structural damage or cracking. When analyzing a system for its capability of withstanding earth and live loading, deflection under proposed conditions is compared to maximum allowable deflection (five percent for PP and PE and three percent for PVDF), and then the adequacy is judged.

Determination of Earth Loads

The method for determining earth loads of a flexible conduit is the Marston Theory of loads on underground conduits. From the theory, it is concluded that the load on a rigid conduit is greater than on a flexible conduit. To determine the earth load on a flexible conduit, the Marston equation for earth loads is used. The ratio of the load on a rigid conduit to the load on a flexible conduit is:

$$\frac{W_c \text{ (rigid)}}{W_c \text{ (flexible)}} = \frac{B_r}{B_f} \quad \text{G-1}$$

$$W_c = C_u w B_u B_c \quad \text{G-2}$$

Where: W_c = load on conduit (lbs/linear ft)
 w = soil density (lbs/ft³)
 B_c = horizontal width of conduit (ft)
 B_u = horizontal width at top of trench (ft)
 C_u = load coefficient

The theory implies that a trench width twice the width of a conduit being buried will result in a load on a rigid conduit twice that of a flexible conduit. Figure G-2 displays the dimensions indicated in Equation G-1.

G

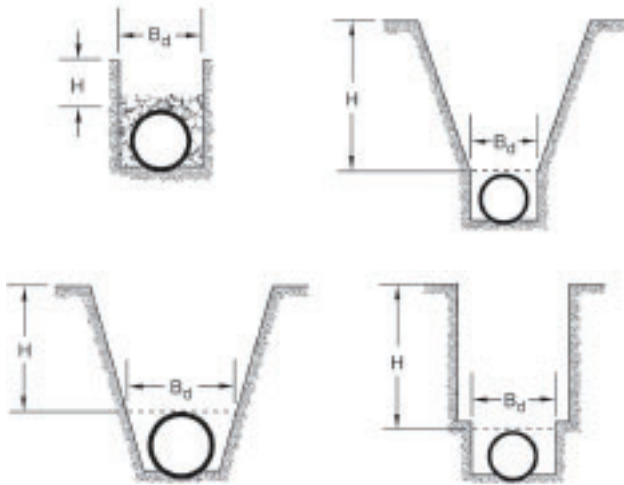

The load coefficient (C_d) depends on the ratio of the height of the fill to the trench width and can be determined from the following equation:

$$C_d = \frac{(1 - e^{-2K\mu H/B_d})}{2K\mu} \tag{G-3}$$

Where: e = natural logarithm base
 K = Rankine's ratio of lateral to vertical pressure
 μ = coefficient for friction between backfill material and sides of the trench

From Equation G-3, a larger load can be expected at increasing widths. As trench width increases, this load increases at a decreasing rate until a value as prism load is attained. For most applications, this value can be calculated as follows:

$$W_c = H w_c \tag{G-4}$$

And prism load, expressed in terms of soil pressure, is as follows:

$$P = W_c H \tag{G-5}$$

Where: P = pressure due to soil weight at depth H (lbs/ft²)
 H = height of fill (ft)

Prism loading is the maximum attainable load in a burial situation and represents a conservative design approach. Due to the fact that frost and water action in a soil may dissipate frictional forces of the trench, the long-term load may approach the prism load. Therefore, it is recommended that this load be considered when designing an underground thermoplastic piping system.

Simplified Method for Burial Design

To properly determine the feasibility of thermoplastic piping systems in a buried application, follow the steps below. These steps will provide the proper design to resist static soil loads.

Step 1.

Determine the soil load exerted on the pipe in lbs/linear foot.

The following information is required:

- Pipe Diameter: _____
- Soil Type: _____
- Trench Width: _____
- Burial Depth: _____

It is critical to pay particular attention to the trenching details. If proper trenching cannot be accomplished, values for the load should be determined using the prism load values.

Actual Soil Load: _____ per linear foot

Step 2.

Determine the E' Modulus of the soil.

E' Modulus values are based on the soil type and the proctor. If on-site conditions are not known, use a low value to be conservative.

E' = _____

Step 3.

Determine the allowable load on the pipe.

The allowable load on the pipe is compared to the actual load to determine the suitability of the burial application. In addition, safety factors can be calculated. Allowable loads are based on the pipe diameter, material, wall thickness, and E' Modulus. To determine the allowable loads please contact Asahi/America Engineering Department.

Max allowable soil load _____ per linear foot.

If the actual load is less than the allowable load, the installation is acceptable, providing that a 2:1 safety factor is present.

Safety Factor = Max allowable load/actual soil load.

SF = _____

If the maximum allowable load is less than the actual load, changes will have to be made, such as burial depth, trench details, or pipe wall thickness. The allowable loads for Duo-Pro® pipe are based on an allowable ring deflection of five percent for PP and HDPE and three percent for PVDF.

Live Load Designs

For applications where live loads are present, a general rule of thumb is to place the pipe five feet below the source of the live load. If piping is only being exposed to a live load for a short length of time and cannot be placed five feet down, it may be advantageous to sleeve the pipe through a steel pipe or enclose it in concrete.

In general, live loads should be added to static earth loads to determine the total load exerted on the pipe under site conditions. In Figure G-3, H₂O highway loading, the effects of live load and static earth loads combined on a pipe can be viewed. In shallow depths, shallower than the five-foot mark, the effect of traffic is significant and needs to be added to the static load to determine the effect. From the graph, it is demonstrated that the effect of a live load becomes minimal at greater depths. In all cases of static and live loads, consult Asahi/America's Engineering Department for assistance on design.

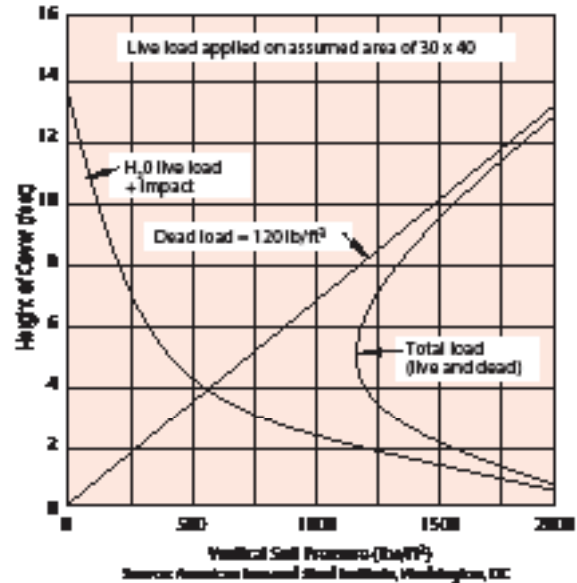

Figure G-3. H₂O highway loading

DOUBLE CONTAINED

Double Wall Chemical Pipe System Design

Double containment piping systems are one of the most economical and reliable methods for protecting against primary piping leaks of corrosive or hazardous fluids. The Duo-Pro® and Fluid-Lok® systems offered by Asahi/America are the original and flagship products of the industry. When designed and applied correctly, the system can be expected to have a long service life that often exceeds 50 years. Double contained systems constructed from thermoplastic materials offer significant cost savings and superior chemical resistance over their metal counterparts. A combination of government regulations, increased concern over environmental and personal safety, and a growing fear of litigation has hastened the development and improvement of double contained piping components into highly engineered systems. With over 25 years of experience in thermoplastic double containment piping, no other company can match Asahi/America's experience and quality.

Use this guide to assist in the design and layout of a double wall pipe system for multiple applications. This guide highlights the areas that an engineer should take into consideration when designing a system.

G

Cost, reliability, and ease of installation can all be improved by careful planning in the conceptual and design phases of any piping project. For double containment systems, the following items must be given careful consideration:

- When to use double containment piping
- Materials of construction
- System selection
- System sizing
- Specialty fittings
- Double contained valves
- Thermal expansion (particularly important in thermoplastic systems)
- Hanging
- Burial
- Welding methods
- UV exposure and weatherability

Leak detection is also an important part of double containment systems. Leak detection of some sort is required on all underground double containment systems. The type of leak detection, the installation method, and the system set-up are very different from system to system. For this reason, leak detection will be discussed separately later in this section.

When to Use Double Containment Piping

Underground EPA Requirements

The US Environmental Protection Agency (EPA) has adopted regulations on underground storage tanks (USTs) and related piping. The EPA states that these systems pose threats to the environment.

EPA regulation 40 CFR 280 spells out the minimum requirements for USTs that contain petroleum or hazardous chemicals.

A summary of the EPA's requirements that affect double containment piping follows.

This is a brief overview. A project engineer needs a thorough understanding of the regulations prior to designing a system.

EPA's Regulations Cover:

Media: All chemicals listed under Subtitle 1 of 40 CFR 280.

Systems: All USTs and related piping.

System requirements: All USTs and pipes must be installed so that a release from the product pipe is contained or diverted to a proper collection system. Containment may be done via a trench, dike, or double containment pipe and tanks. The containment materials must be able to hold the leaking product for a minimum of 30 days. By then, scheduled inspections and periodic monitoring should identify the failure and correct the situation.

Leak detection: Drainage and suction lines require monthly manual inspections for product line leaks. Pressurized systems require automatic monitoring for product failure. In case of a leak, the system must automatically restrict flow of the product.

Compliance dates: The EPA has set requirements for the date of compliance for both new and existing systems. Contact Asahi/America for the latest standard, or visit the EPA's web site at www.epa.org.

Above ground: In addition to the EPA requirements for below grade systems, many companies have adopted policies for overhead piping to protect personnel from a possible leak of a harmful chemical.

Materials of Construction

The majority of double containment systems installed worldwide are thermoplastic due to the ease of joining and chemical resistance to hazardous media and underground moisture. Asahi/America offers several materials to handle a wide range of applications.

Materials include:

- Polypropylene
- PVDF
- E-CTFE: Halar®
- HDPE: High Density Polyethylene

The carrier pipe (the inner pipe also known as the product pipe) material is selected based on common piping practices using variables such as:

- What chemical(s) will be in contact with the system?
- What are the chemical concentrations?
- At what temperature will the system operate?
- At what pressure will the system operate?
- What is the flow of the media in the system?

By answering these questions, the proper materials of construction for the carrier can be selected for the project. To assist in the material selection, refer to the chemical resistance tables in Section D. A thermoplastic

system's ratings for temperature and pressure are based on water. The addition of certain chemicals will add stress to the system and may reduce the recommended operating parameters. For less aggressive chemicals, the use of printed resistance tables is perfectly suitable. For more aggressive chemicals or mixtures of chemicals, the manufacturer of the pipe system should be consulted.

After verifying the standard operating conditions, it is necessary to examine other operations that might affect the piping. The following is a sample of items to investigate prior to specifying a material.

- Will there be spikes in temperature or pressure?
- Is there a cleaning operation that the piping will be exposed to?
- If yes, what is the cleaning agent? At what temperature will the cleaning be conducted?
- Will the system be exposed to sunlight or other sources of UV?

Each of the previous questions should be answered, and the desired material should be checked for suitability based on the above factors, as well as any others that might be special to the system in question.

Finally, in addition to verifying the temperature, pressure, and media within the thermoplastic pipe material, it is also necessary to verify other components in the system, such as valves, gaskets, valve seat and seals, etc. These should be examined in the same manner as the pipe material.

Once the product pipe has been selected, the containment pipe must be selected. In most cases, the containment pipe is the same as the carrier pipe, such as in polypropylene and HDPE systems. Using the same material internally and externally yields many time-saving advantages on a project. However, in many systems where the product pipe required is a more expensive material, such as PVDF or E-CTFE, a polypropylene outer shell is often used.

Sizing the containment pipe requires the consideration of many factors that are different than those used to size the carrier.

These include:

- Static and live burial loading

- Leak detection requirements
- Hanging requirements for above-ground applications
- Physical space constraints
- Manufacturability and availability
- Operating pressure

When a double contained system is buried, the containment pipe bears the static soil load and the dynamic loading imposed by traffic, equipment, etc. Section C provides a detailed discussion for calculating static and dynamic loading to determine the required wall thickness.

Leak detection requirements must also be considered. Depending on the type of leak detection chosen, there may be minimum requirements for the amount of annular space necessary for successful installation and operation. As a general rule of thumb, a minimum of 3/4" of annular space is required for the installation of a continuous cable system. Leak detection options are discussed in detail later in this section.

Hanging requirements and physical space constraints are also important considerations. Often, trenches or pipe racks are crowded with other systems, so the containment must not be too large. The designer of a system should specify the exact hanger location instead of leaving this portion up to the installer.

Manufacturability and availability can also influence the selection of containment pipe. There must be adequate clearance between the carrier and containment to facilitate efficient manufacturing. This is especially important for the manufacturing of fittings. Asahi/America has spent several years improving fabrication techniques to offer the widest variety of sizes in the marketplace. The designer should also be careful to design with standard pipe sizes to avoid costly delays due to lack of availability.

Operating pressure parameters may be quite different for the containment pipe than for the carrier. Often, systems are designed so that any leaks into the annular space drain directly into a manhole or sump. In these open-ended systems, it is virtually impossible to build up significant pressure. As a matter of economy, the containment pipe often has a lower pressure rating and therefore a higher dimensional ratio than the carrier pipe.

The final consideration when choosing the containment

G

pipe is the environment in which it will be installed. Outer UV exposure is not ideal for polypropylene systems, and protection of the pipe may be required. If surrounding temperatures are extremely low, then certain materials will become brittle in the cold. Consult Asahi/America for specific recommendations in these cases.

System Selection

As stated in the previous section, the material must be selected based on the media to run through the system, as well as the operating conditions such as pressure, temperature, and media concentration. In a double containment system, the selection of pipe and associate pipe pressure ratings can be complex, as any combination of material can be used.

Asahi/America offers three systems for double containment piping:

- Duo-Pro®
- Poly-Flo®
- Fluid-Lok®

Each system has its ideal purposes and advantages. A description of the three systems follows.

Duo-Pro®

The Duo-Pro® system is the flagship of the Asahi/America double containment piping system offerings. Duo-Pro® is available in polypropylene, PVDF, E-CTFE, and in any combination of the three. Duo-Pro® is available in systems ranging from 1"x 3" to 18"x 24". In addition, larger systems have been made available on request.

Duo-Pro® is a fabricated system made from extruded pipe and primarily molded fittings. It has a complete range of molded pressure fittings that are fabricated into double containment fittings at the factory. In addition, Duo-Pro® is ideal for drainage applications, having a whole compliment of fittings for drainage applications. It can be assembled using simultaneous butt fusion or staggered butt fusion.

The Duo-Pro® system is assembled using a support disc on each end of a pipe or fitting. The support disc centers the carrier inside the containment and locks the two pipes together for simultaneous fusion. On pipe runs, the spider clip fitting is used to support the pipe inside the containment piping. Spider clips are spaced based on hanging criteria by size and material and are designed to avoid the point loading of the pipes.

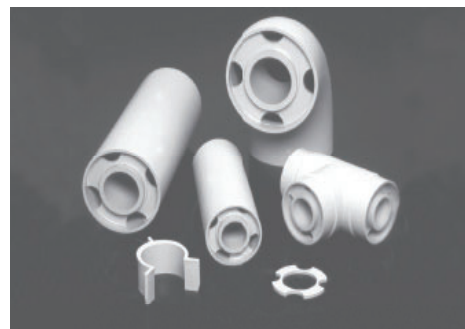

Figure G-4. Support discs and spider clip fittings

Per the EPA's requirements, any double contained system needs to have leak detection. The methods of leak detection include manual inspection, low point sensors, and continuous leak detection cable. The leak detection cable is installed in between the annular space between the inner and outer pipe. Duo-Pro® is designed to provide sufficient space for the installation of a leak detection cable. Contact Asahi/America technical staff for an exact recommendation.



Figure G-5. Duo-Pro® piping system

Poly-Flo®

The Poly-Flo® system is a unique dual extruded and molded system. In all other double containment pipe systems, the inner and outer components are made separately and then assembled into a double wall configuration. This adds time and labor to each project. The Poly-Flo® system produces both the inner and outer piping at the same time. Asahi/America's patented extrusion process locks the pipe together by use of continuous support ribs. In addition, most fittings in the system are molded as single-piece components. The only deviation is HDPE material, where many fittings are fabricated from double wall pipe.

Poly-Flo® is available in 1"x 2", 2"x 3", and 4"x 6".

(Consult Asahi/America for the availability of 6"x 8".) Poly-Flo® is available in three materials: black polypropylene (UV stabilized), PVDF, and HDPE. It is a unique system, where the carrier pipe has an OD consistent with IPS pipe, while the outer pipe is a jacket not corresponding to an IPS dimension.

Poly-Flo® is assembled using simultaneous butt fusion only. The system is available with manual and low-point leak detection sensors only. The use of a leak detection cable is not possible due to the limited annular space.



Figure G-6. Poly-Flo® piping system

Fluid-Lok®

The Fluid-Lok® system is an all HDPE system. It is manufactured in a similar process to the Duo-Pro® system. Fluid-Lok® is available in many sizes, ranging from 1"x 3" to systems as large as 36"x 42".

Besides being an all HDPE system, Fluid-Lok® is different than Duo-Pro® in that most fittings are fabricated and not molded. Fabricated fittings are ideal for the application of long sweep 90s and 45s, which are often required in these systems. Fluid-Lok® is designed to accommodate leak detection low-point sensors or cable. In addition, HDPE manholes are available and can be directly welded to the pipe system to avoid unnecessary fittings and provide more consistency and leak protection.



Figure G-7. Fluid-Lok® piping system

The availability of many materials and three piping systems creates many choices. Each system is designed for specific applications and assembly techniques. To assist in the proper selection of the system, consider the following questions and answers.

Question/Answer

- Q: Are you operating under pressure or drainage?
 A: Pressure systems may need to have consistent pressure rating fittings on both the carrier and containment pipe. DWV fittings are not allowed in pressure systems.
- Q: Do you require consistent pressure ratings on the carrier and containment?
 A: If not, cost can be saved by using 150psi carrier piping and 45psi containment piping.
- Q: What material are you using?
 A: Material requirements may determine the system you can choose.
- Q: Do you require continuous cable leak detection?
 A: Only the Duo-Pro® and Fluid-Lok® systems can accommodate cable systems.

System Sizing

It is recommended to maintain flow rates below a velocity of 5 ft/second when using any thermoplastic with a hazardous chemical. High velocities can lead to water hammer in the event of an air pocket in the system. Water hammers can generate excessive pressures that can damage a system. For safety reasons, high velocities should be avoided.

In addition, high velocities also mean added pressure drop, which, in turn, increases demand on the pump. If the flow velocity is not required, it is recommended to size a system with minimal pressure drop. It is also recommended to oversize a design to allow for future expansion or chemical demand. Once a system is in place, it is difficult to add capacity to it.

Specialty Fittings

Double containment systems, for the most part, can be thought of in the same manner as single wall piping systems with a few exceptions. In a double wall system, the issue of thermal expansion is more complicated, welding is similar but not the same, and the outer containment pipe must have a start and stop.

The major fitting that sets Asahi/America systems apart from all other double wall systems is the patented Dogbone™ force transfer fitting. The Dogbone™ fitting can be used in many ways to assist in the design of a proper double containment piping system.

The Dogbone™ is used for:

- Locking the inner and outer pipes together
- Compartmentalizing pipe section
- Termination of the containment pipe
- Sensor installation
- Control of thermal expansion

Figures G-8 through G-11 depict a few uses of the Dogbone™.

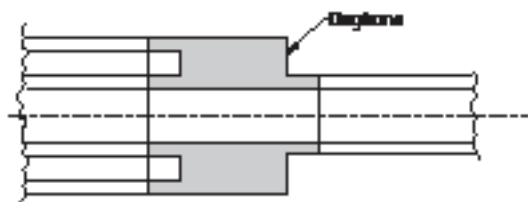

Figure G-8. Outer containment termination

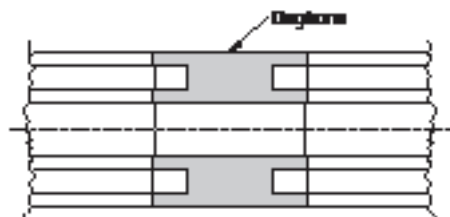

Figure G-9. Locking inner and outer pipes

Dogbones™ are available in solid and annular forms. A solid Dogbone™ does not allow the passage of fluid in the annular space to pass through, while annular Dogbones™ will allow the passage. The placement and purpose of the fitting will determine the style required.

Dogbone™ fittings are available in the Duo-Pro® and Fluid-Lok® systems. The Poly-Flo® system does not require the fitting, as the pipe is continuously supported and locked together.

Finally, the Dogbone™ can be used for connecting low-point leak detectors, ventilation, and drainage. When designing a double wall system, it is important to incorporate high point vents to eliminate air from the system. In addition, in the event of a leak, a drainage method for the containment pipe is required. Connection methods for these valve requirements are shown in Figures G-10 through G-13.

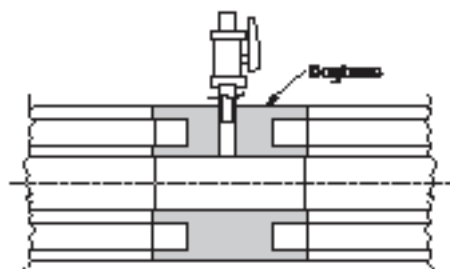

Figure G-10. Ventilation of inner pipe: Duo-Pro® and Fluid-Lok®

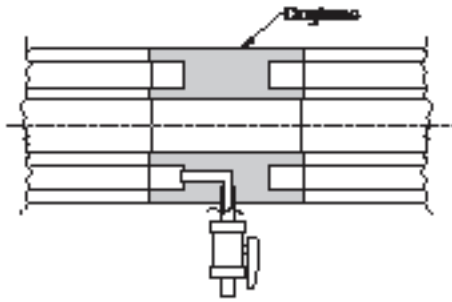

Figure G-11. Drainage of containment pipe: Duo-Pro® and Fluid-Lok®

Double Contained Valves

In pressurized systems, the necessity of valves can be accomplished without interrupting the integrity of the double containment system. Double contained valves are available in many shapes and forms; they are also available in any style valve, such as ball, butterfly, diaphragm, check, and gate. The valve selected, based on the application, determines the shape of the outer containment.

The following figures demonstrate a few valve configurations that are available from Asahi/America. Other options are readily available on request.

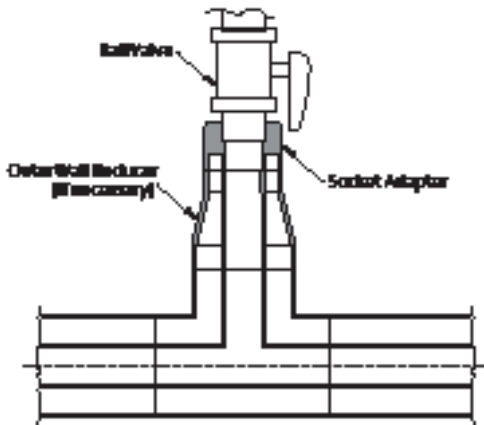

Figure G-12. Ventilation of inner pipe: Poly-Flo® system

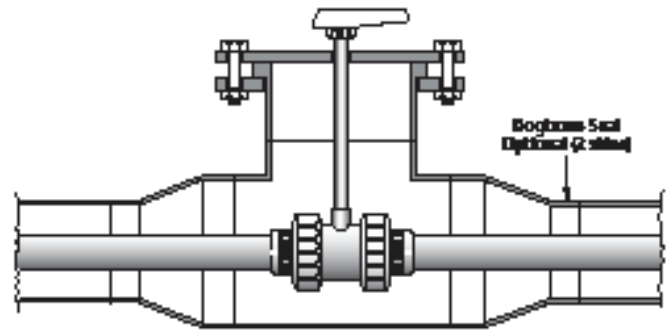

Figure G-14. Double contained ball valve with stem extension: Duo-Pro® system

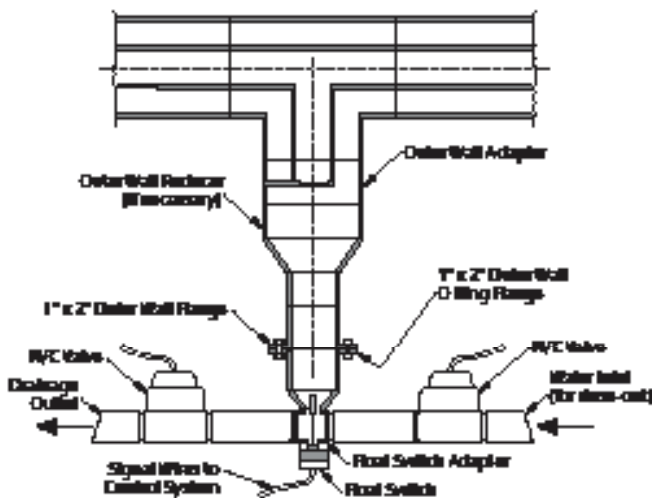

Figure G-13. Drainage of containment pipe: Poly-Flo® system with low point sensor

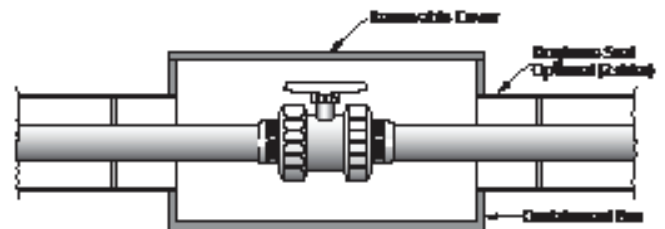

Figure G-15. Double contained ball valve without stem extension: Poly-Flo® system

G

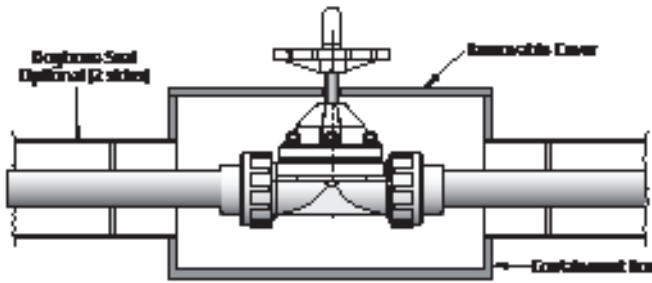

Figure G-16. Double contained diaphragm valve with stem extension: Poly-Flo® system

More than valves can be installed. Items such as flow meters and temperature and pressure monitors can also be incorporated into the internal containment portion of the system. Contact Asahi/America's Engineering Department to discuss your particular needs. It is important to specify and design in the need to access valves for maintenance purposes.

Thermal Expansion

Based on your operating criteria, thermal expansion may need to be considered. For systems maintained at consistent temperatures, compensation for thermal effects may not be required. In a double contained piping system, three types of expansion can occur:

- The carrier pipe is exposed to thermal changes, while the containment remains constant. This is typically possible when the carrier pipe is exposed to liquids of various temperatures, while the outer containment is in a constant environment, such as in buried applications.
- The containment piping experiences thermal changes, while the carrier remains constant. The typical application is outdoor pipe racking with constant temperature media being transported in the carrier.
- Both inner and outer pipes experience temperature changes.

The Dogbone™ fitting is a proven and effective way to control thermal expansion where a restrained system is acceptable. It can also be used to direct the growth of a flexible system. For systems maintained at consistent temperatures, compensation for thermal effects may not be required. However, it is important to review all aspects of the operating environment, such as:

- Is it outdoors where it will be exposed to changing weather?
- Is the system spiked with a high temperature cleaning solution?
- Will the system run at a significantly higher or lower temperature than the installation temperature?

The occurrence of any thermal change in a plastic system will cause the material to expand or contract.

Thermoplastic systems can be used in hot applications and applications where the temperature is cyclical; it just requires analysis of the thermal expansion effects. In most cases, the use of expansions, offsets, and proper hanging techniques is all that is required to ensure a proper design.

Hot systems also reduce the rigidity of thermoplastic piping, which, in turn, decreases the support spacing between hangers. In smaller dimensions, it is recommended to use continuous supports made of some type of channel or split plastic pipe.

Finally, the use of hangers as guides and anchors becomes important. Certain hangers should be used as guides to allow the pipe to move in-line, while other hangers should be anchoring locations used to direct the expansion into the compensating device. The anchors and hangers should be designed to withstand the thermal end-load.

In a buried system, the standard Dogbone™ fitting will lock the inner and outer pipes together. The surrounding ground and fill should eliminate the movement of the outer pipe. In systems that are hung, the outer pipe hanger must withstand the thermal end-load. To properly hang these systems, a special Restraint Dogbone™ is recommended at the hanger locations.

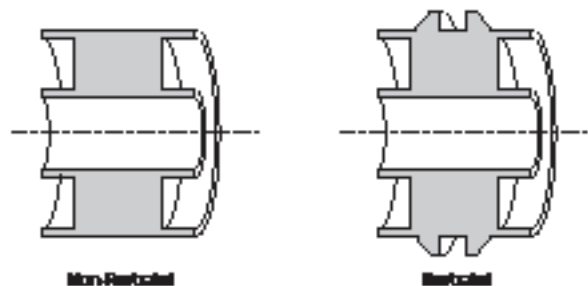

Figure G-17. Dogbones™

Hanging

As in any thermoplastic system, the selection of hangers is an important decision. Hangers that scratch or create point loads on the pipe are not recommended. The ideal hanger is a thermoplastic component. In many cases, an all-plastic hanger may not be available. In these cases, a metal hanger is acceptable, but precautions should be taken. Any sharp edges on the hanger should be removed. A cushion made of rubber is recommended in the event that the pipe shifts because it will prevent scratching.

Burial

Due to EPA requirements, the burial of double containment piping is a common practice. In most cases, the burial of a double wall pipe is the same as that of a single wall pipe system. Careful consideration of the soil type, compaction, trench detailing, back fill, load, etc. is necessary when considering the proper design.

Live loads also pose the added complication when burying a system. It is important to look at the possibility of the pipe system being driven over, as well as the type of vehicle that would be creating the live load.

In the design, it is imperative to call out the recommendations of the burial in the details of the drawing set. By calling these details out, the contractor will be in a better position to properly install the pipe as required.

Welding Methods

All double containment systems offered by Asahi/America are available for butt fusion assembly. Butt fusion provides reliable fusion, but it is also ideally suited for the double wall system. By properly aligning the carrier and containment piping with the support disc, both the inner and outer pipe can be welded at the same time. This reduces the assembly time, as well as the need for extra fittings such as couplings. What can be accomplished in one weld can take up to four welds in other systems (weld the inner and outer separately on either side of a coupling).

When building a system that is made of dissimilar materials (example: PVDF x Pro 45), the pipes cannot be welded simultaneously due to different heat and joining force requirements. For these systems, staggered welding is required, where the inner pipe is welded first and the outer pipe welded second using a special annular heating element. Staggered fusion

does take more time due to the extra welds, but it still proves to be economical when compared to using similar materials such as PVDF on both the carrier and containment pipe, depending on pipe size, project requirements, and installation environment.

UV Exposure and Weatherability

All thermoplastic materials react to the exposure of UV differently. PVDF and E-CTFE materials are completely UV resistant over the course of their design life. However, certain chemicals containing Cl anions exposed to UV light can create a free radical Cl that will attack the PVDF pipe wall.

Polypropylene is not UV stable. In direct exposure to sunlight, it will break down. The effect can be seen in a noticeable color change in the pipe. In pigmented PP systems, the color change will actually create a protective shield on the outer layer of the pipe and prevent further degradation. For PP pipes with a wall thickness greater than 1/4", the effect of UV is normally reduced and can be used outside. However, it is still recommended to protect it from UV exposure for added safety.

The Fluid-Lok® HDPE material is UV stabilized. Fluid-Lok® pipes contain carbon black to make the material UV stable and acceptable for use in outdoor applications. Other HDPE materials made by other manufacturers may require protection. Be sure to consult manufacturer prior to selecting a pipe system.

Leak Detection Design

In all buried applications of double containment piping, the EPA (40 CFR 280) has set a requirement for leak detection. Drainage and suction lines require monthly manual inspections for product line leaks. Pressurized systems require automatic monitoring for product failure. In case of a leak, the system must automatically restrict the flow of the product.

Asahi/America's systems are designed to accommodate many different technologies for detecting a leak. The following methods are acceptable:

- Low-point leak detection sensors
- Continuous leak detection cable systems
- Visual inspection (only acceptable on drainage systems)

The selection of the leak detection system will play



a critical role in the layout of the piping system. For instance, if a cable method is used, it will require additional fittings, called access ports for pulling the cable. Pipes and fittings will need to be ordered with pull ropes installed at the factory. Finally, the placement of the cable will need to be factored in. For some installations, only the main trunk line will have cable; in others, the cable will split and run up each of the branch lines.

This guide has been created to assist in the pipe layout and design of a leak detection system. Each type of system is discussed in regard to its use in an Asahi/America double containment piping system.

Low Point Leak Detection Sensors

Low point leak detection sensors can be used in any of Asahi/America’s double wall systems:

- Poly-Flo®
- Duo-Pro®
- Fluid-Lok®

For the Poly-Flo® system, low-point sensors are the only automatic system available.

Low-point leak detection is relatively straightforward in terms of design. The sensing technology consists of either capacitive or float-type switches. These switches are placed in strategic locations throughout a system to properly identify leaks and then determine their location within a reasonable length of pipe. If an insufficient amount of sensors is used and a leak occurs, determining the location of that leak can be extremely difficult, especially if the piping is buried. It is always more practical to use a few more sensors at the time of installation, as it could lead to huge cost savings in the long run in the event of a system leak.

Mounting of the Sensor

Asahi/America pipe systems can accommodate mounting sensors in a variety of different methods. In some cases, it is ideal to place the sensor with as tight of a profile to the pipe as possible; in other instances, a low-point leak sensor installation may also require a valve for drainage. When using low-point sensors in below-grade applications, it is important that special considerations are taken in the excavation to ensure that the sensors are not damaged during installation or back fill.

Figures G-18 through G-21 depict a few assemblies for mounting low-point sensors into the annular space of a double contained pipe system.

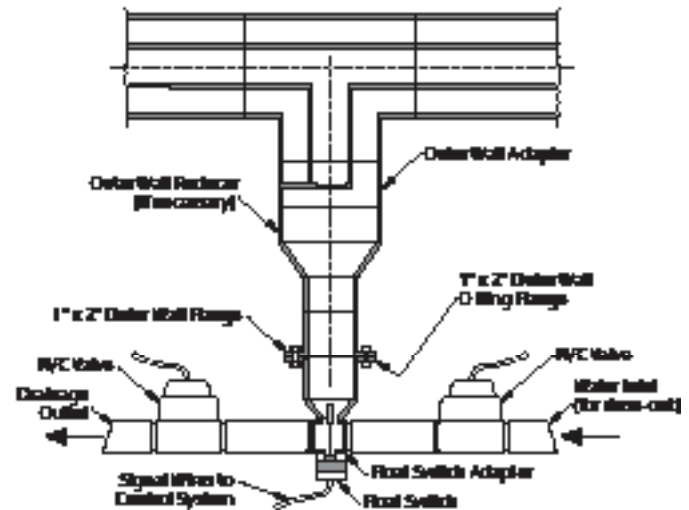

Figure G-18. Drain and low-point Poly-Flo® system

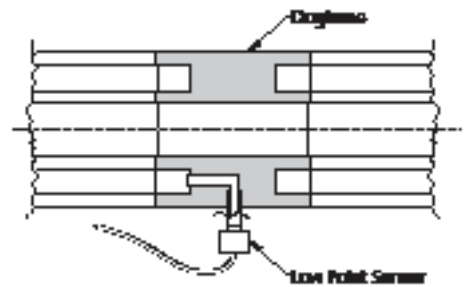

Figure G-19. Simple connection, Duo-Pro® Fluid-Lok® systems

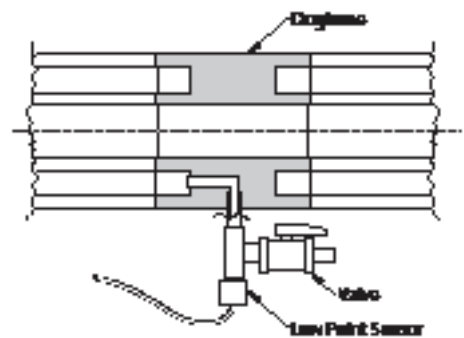

Figure G-20. Connection with drain valve, Duo-Pro® Fluid-Lok® systems

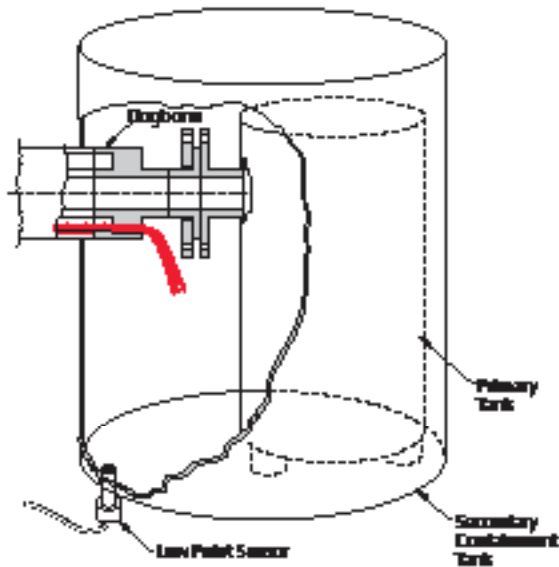

Figure G-21. End-of-line connection option, Duo-Pro® / Fluid-Lok® systems

Location of the Sensors

The location of the sensors should be based on finding the leak with relatively no confusion. By placing the sensors on the branch of tees or lateral (wye) type connections, the line causing the leak is easily identified. In addition, placing the sensor every 100 to 150 feet reduces the area that would be in question if a leak was to occur.

Figure G-22 shows an example of a system and the ideal locations for the low-point sensors.

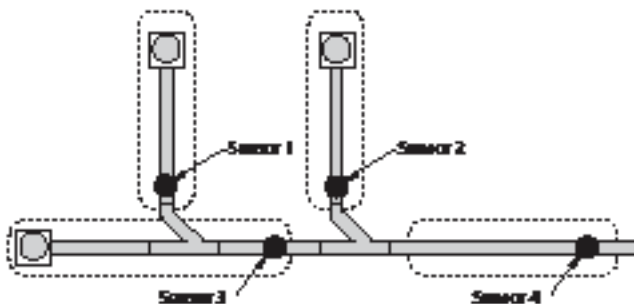

Figure G-22. Sample locations for low point sensors

Compartmentalizing the System

The practice of compartmentalizing the outer containment pipe is in conjunction with the strategic placement of sensors. Should a major leak were to occur, it is possible that more than one sensor could be tripped in a short time frame. If you have no way of knowing which sensor tripped first, then the value of multiple sensors is lost.

Using the Dogbone™ fitting, sections of the annular space can be made into individual compartments. In the case of a leak, the fluid will pass into the annular space, but it will be locked into a compartment and not allowed to spread throughout the system. This method has two advantages: one helps to identify leak locations, and the other reduces the need to dry out a large section of the annular space once the leak is found and repaired.

Figure G-23 demonstrates the use of solid Dogbones™ to create compartments.

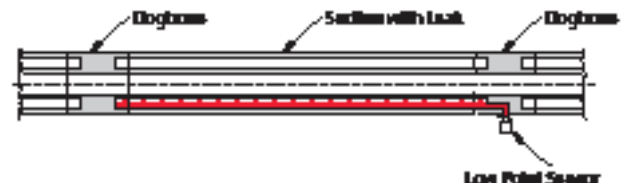

Figure G-23. Leak detection compartments

Continuous Cable Leak Detection Systems

Continuous cable leak detection systems offer the best method for locating a leak in the annular space of a double containment pipe system. A cable system can generally pinpoint the location of the leak with an accuracy of ± 0.5 feet. It can also incorporate low-point probes to offer maximum flexibility to the designer. Entire systems can be mapped out, installed, and fed back to an easy-to-understand operating panel. Most large systems use leak detection cable as the preferred method for monitoring the system.

All pressure double wall pipe systems are required to have automated leak detection in below-grade applications. In these cases, cable is the recommended method.

The discussion of leak detection cable is broken down into two topics: the pipe layout requirements and the electrical cable layout requirements.

Pipe Layout Requirements (Annular Space)

Leak detection cable can be used in the following Asahi/America systems:

- Duo-Pro®
- Fluid-Lok®

Unfortunately, due to the narrow annular space in a Poly-Flo® system, the cable cannot be pulled through the system, eliminating its use. Continuous cable systems require a minimum of 3/4" of annular space to pull cable through easily. In Duo-Pro® and Fluid-Lok® systems, certain pipe configurations can have small annular space, making the cable pull difficult or impossible. For instance, 1 x 3 Pro 150 x 150 Duo-Pro® systems have a 0.813" space all around. After accounting for the weld bead, the space will be lower than 0.75". For this application, 1 x 4 Pro 150 x 150 or 1 x 4 Pro 150 x 45 should be considered to ease the installation. Consult Asahi/America's Engineering Department for the available annular space on Duo-Pro® systems and Fluid-Lok® systems.

To clarify once again, for ease of installation, the annular space needs to be a minimum of 3/4" to accommodate easy cable pulls.

Pipe

There are no special requirements for pipe. Both the Duo-Pro® and Fluid-Lok® systems are designed to accommodate cable leak detection. Support discs on the ends of pipe and fittings provide a wide opening on the bottom of the pipe, as well as either cut outs or vent holes in other sections, depending on the pipe size. On pipe runs, the carrier pipe is supported by the use of spider clips, which support the carrier pipe without blocking the bottom of the annular space.



Figure G-24. Two typical end-of-pipe support discs to accommodate leak detection

There are only two important items to keep in mind. When ordering pipe, ensure that pull rope is ordered to be installed on the pipe. The second is during installation; it is critical to align the pipe and fittings properly to ensure that support disc openings are located on the bottom. Forgetting this can lead to significant difficulty when trying to pull cable into the

system.

Access Points

Asahi/America offers a standard fitting for accessing the annular space, known as the Access Tee or Pull Port Tee. While it can be common practice in HDPE systems to cut windows into the pipe to access the rope or cable and then weld a saddle on afterward, this is not an acceptable design. While it is possible to cut windows, this should only be used when the rope or cable is caught in the line and no other alternative is available.

Access tees are supplied with a low-pressure thread-on cap; for full pressure rating on the outer wall pipe, a flange and blind flange configuration is available.

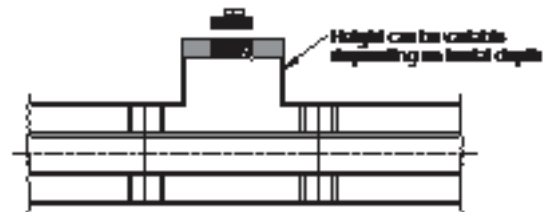

Figure G-25. Access tee with threaded cover

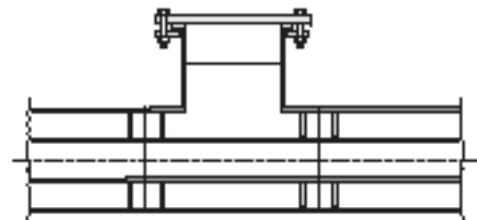

Figure G-26. Access tee with flanged cover

Access tees are supplied in two pieces, allowing the installer to weld the proper pipe height to the tee base to come up to grade.

Once the selection of the access tee style is determined, the strategic location of the pull ports is required. In general, pull ports should be located at no more than 500-foot intervals on straight runs. Each 90° change in direction is approximately equal to 150 feet of straight run. Pull ports should be installed to avoid binding the pull rope. Access tees should also be placed at the beginning and the end of branch locations requiring cables. For tie-ins to the main cable, it is best to place the access tee on the main run in front of the branch location.

Figure G-27 shows a small schematic on a drainage



system and the proper location of the access port.

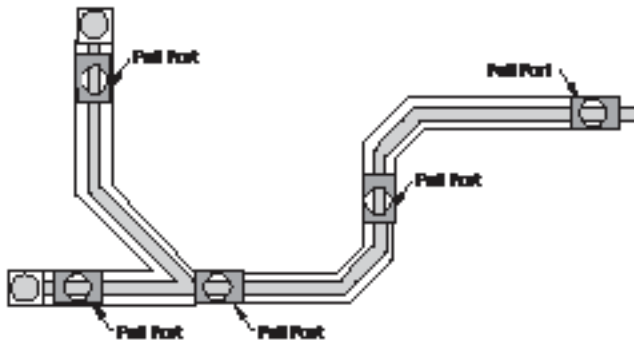

Figure G-27. Pull port locations for leak detection cable

Dogbones in a Cable System

In a double containment system, the Dogbone™ fitting is used to lock the inner pipe together for proper restraint or for the control of thermal expansion. Unlike low-point systems, creating compartments in the system is not practical. If Dogbone™ fittings are required in the system, the use of the annular style is required to allow cable to pass through.

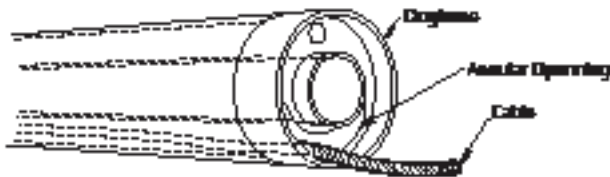

Figure G-28. Annular Dogbone with cable

Sensor Cable Requirements

Sensor Cable

The proper selection of the sensor cable is imperative to the successful operation of any leak detection system. Most systems use a specially designed coaxial cable for sensing leaks. Some cables are designed to sense only water, others are designed to sense corrosive chemicals, and some are designed to sense the presence of hydrocarbons. There are also combinations of these available that can sense corrosive water-based liquids while ignoring hydrocarbons and vice versa; in addition, there are some cables that can sense water and hydrocarbons. These selections increase the flexibility of system applications. The chemistry of the media must be considered to ensure the proper selection of the sensing cable.

Jumper Cable

Jumper cable is used to connect sensor cable segments and probes together to form the sensing string. Jumper cable is not affected by contact with water. However, installation in conduit is recommended to prevent physical damage. If needed, jumper cable can be directly buried.

The Connectors

The cable connection is perhaps the most critical component to a hassle-free commissioning of the system. Factory training of all personnel installing connectors is strongly recommended to save many hours troubleshooting a system with poor connections. The connectors are typically standard UHF coaxial cable connectors that are connected together with an adapter. Because there is the possibility of the connection getting wet in the event of a leak, each connection must be carefully sealed with shrink tubing upon the commissioning of the system.

The Control Panel

The control panel is the heart of the leak detection system. It is typically mounted in a location that is convenient for an operator to monitor its status. The control panel can be ordered in several configurations. Some are multi-channel devices that are capable of monitoring several systems simultaneously. Care must also be taken to specify a panel that is capable of monitoring the required length of sensor cable. The control panel should have a visual readout of some sort and a keypad for operation. It should also provide provisions to interface with a computer to use diagnostic and programming tools that are available.

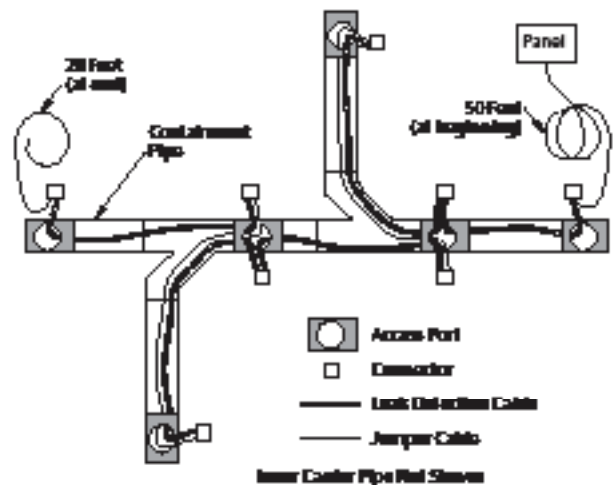

Figure G-29. Layout of the cable with jumpers

G

Visual Inspection Monitoring

For drainage-only applications, an alternative method to automated leak detection is manual inspection. As long as monitoring can be accomplished every 30 days and recorded, manual inspection is allowed. For manual inspection, low-point drains are placed at collection points in line as required. By designing in-wells, systems can be opened and the annular space can be inspected to sight a possible leak. Manual inspection can also be accomplished at the end of the line. Figures G-30 and D-38 show two possible designs for manual leak detection. Probes can also be placed in wells as a manner of automated detection with a view point.

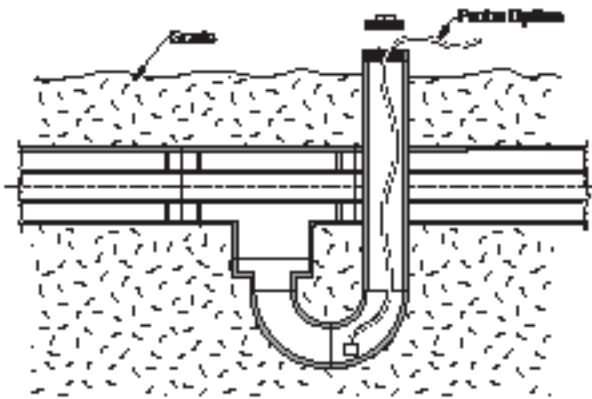

Figure G-30. In-line inspection well

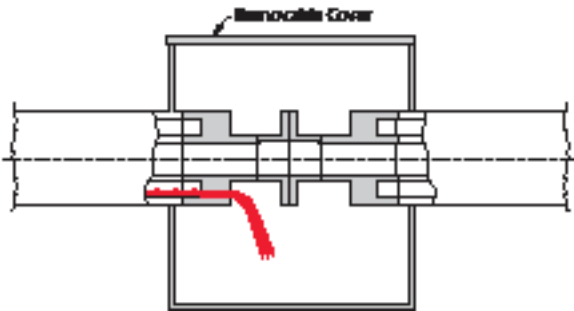

Figure G-31. End-of-line inspection well

Burial Practices for Double Wall Piping

The procedure is the same as that of a single wall system. All calculations should be based on the outer wall, containment, pipe OD, and wall thickness.

If leak detection cable is used on a buried double wall system, it is necessary to calculate the actual deflection and the resulting annular space to ensure that the cable will have adequate clearance. See Figure G-32.

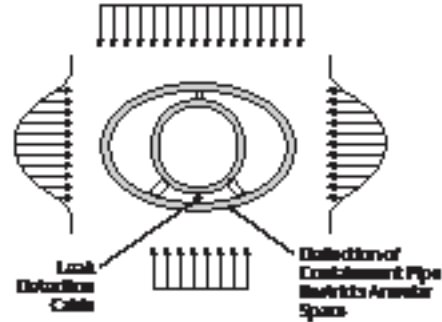

Figure G-32. Deflection of double contained pipe

The following formula is used to calculate deflection on the containment pipe.

$$\Delta X = \frac{(K W_c D_1^3)}{(E I + 0.061 E' r^3)} \tag{G-6}$$

- Where:
- ΔX = horizontal deflection based on inside diameter (in)
 - D_1 = deflection lag factor (use 1.5)
 - K = bedding constant (Appendix B)
 - W_c = Marston load per unit length of pipe (lbs/linear in)
 - r = radius of pipe (in)
 - E = modulus of elasticity of pipe materials (psi)
 - I = moment of inertia of the pipe wall ($I = t^3/12$ (App. A, Tables A-26 to A-32))
 - E' = modulus of soil reaction (psi)

Installation of a Buried System

These preparations can be used for either single wall or double contained piping systems.

Trench Preparation – General

The recommended trench width for both single and double wall can be found by adding one foot to the width of the pipe to be buried. Larger trench widths can be tolerated, but trench widths greater than the diameter plus two feet typically produce large loads on the pipe. For small diameter pipes (4" and less), smaller trench widths are suggested. The important point to remember is that the trench width at the top of the conduit is the dimension that determines the load on the pipe. Therefore, the sides of the trench can be sloped at an angle starting above this point to assist with minimizing soil loads in loose soil conditions (prior to compaction).



If the trench widths described are exceeded, or if the pipe is installed in a compacted embankment, it is recommended that embedment should be compacted to 2-1/2" pipe diameter from the pipe on both sides. If this distance is less than the distance to the trench walls, then the embedment materials should be compacted all the way to the trench wall.

When installing long lengths of piping underground, it may not be necessary to use elbows, as long as the minimum radii of bending for specific diameters and wall thicknesses are observed. If the soil is well compacted, thrust blocks are not required. However, if changes of directions are provided with tees or elbows, or if the soil is not well compacted, thrust blocks should be provided. The size and type of a thrust block are related to maximum system pressure, size of pipe, direction of change (vertical or horizontal), soil type, and type of fitting or bend. To determine the thrust block area, it is suggested that a geotechnical engineer be consulted and soil bearing tests be conducted, if deemed necessary.

If the bottom of the trench is below the water table, actions must be taken to adequately correct the situation. The use of well points or underdrains is suggested in this instance, at least until the pipe has been installed and backfilling has proceeded to the point at which flotation can no longer occur. The water in the trench should be pumped out, and the bottom of the trench should be stabilized with the use of suitable foundation material, compacted to the density of the bedding material. In a double containment system, annular spaces must be sealed to prevent water from getting into the space.

For unstable trench bottoms, as in muddy or sandy soils, excavate to a depth of four to six inches below the trench bottom grade, backfill with a suitable foundation material, and compact to the density of the bedding material. Be sure to remove all rocks, boulders, or ledges within six inches in any direction from the pipe. At anchors, valves, flanges, etc., independent support should be provided by the use of a reinforcing concrete pad poured underneath the pipe that is equivalent to five times the length of the anchors, valves, or flanges. In addition, reinforcing rods should be provided to securely keep the appurtenance from shifting, thereby preventing shearing and bending stresses on the piping. It is strongly suggested that an elastomeric material be used to prevent stress concentration loading on the piping caused by the reinforcing rod.

Laying of Pipe Line and Backfilling Procedure

Caution must be exercised so that straight lengths or piping prepared above ground does not exceed the minimum bending radius of the piping. For a given trench height, "h," the minimum length of piping necessary to overcome failure due to bending strain can be determined by the following procedure.

Step 1.

Determine trench height = "h." This trench height will equate to the offset value "A."

$$A = 2R_b \sin \alpha \quad (G-7)$$

Step 2.

Determine R_b from longitudinal bending tables (see Appendix A) for the pipe diameter to be laid.

Step 3.

Determine the angle of lateral deflection (α).

$$\alpha = \sin^{-1} \left\{ \frac{h}{2R_b} \right\}^{1/2} \quad (G-8)$$

Step 4.

Determine the central angle β .

Step 5.

Determine the minimum length "L" in inches.

$$L = \frac{R_b}{57.3} \quad (G-9)$$

Where: h = A = height of trench (in)
 β = 2α = central angle (degrees)
 R_b = radius of bending (in)
 (Appendix A)
 L = minimum laying length (in)

If the value determined in Step 5 is greater than the entire length to be buried, due to a deep trench or short segment, then the entire length should be lifted with continuous support and simultaneously placed into the trench.

If the pipe is pulled along the ground surface, be sure



to clear the area of any sharp objects. Some means to prevent scarring to minimize soil friction should be used. Because the allowable working stress at the pipe laying surface temperature should not be exceeded, pulling force should not exceed:

$$PF = SF \times S \times A \tag{G-10}$$

Where: PF = maximum pulling force (lbs)
 S = maximum allowable stress (psi)
 A = cross-sectional area of pipe wall (in²)
 SF = safety factor = 0.5

Because the soil will provide friction against a pipe that is being pulled on the ground, a length "L" will be achieved where the pipe can no longer be pulled without exceeding the maximum allowable stress of the piping. This length can be estimated by:

$$L = \frac{2.3 SF S}{(\mu \cos \theta + \sin \theta)} \tag{G-11}$$

Where: L = maximum pulling length (feet)
 S = maximum allowable stress (psi)
 SF = safety factor = 0.5
 μ = coefficient of friction between the soil and pipe wall
 θ = gradient (ground slope)

Muddy soil with a low coefficient of friction will allow for a longer length to be pulled.

For small diameter pipes (2-1/2" and under), the pipe should be snaked, especially if installed during the middle of a hot summer day. The recommendations for offset distance and snaking length should be observed, as outlined in the Thermal Expansion section. It is suggested that the laying of the pipe into the trench on a summer day take place first thing in the morning to minimize thermal contraction effects. For larger diameter pipes with well-compacted soil, friction should prevent pipe movement due to thermal expansion and minimize the need for snaking, although it is still recommended.

The initial backfilling procedure should consist of filling in on the sides of the piping with soil that is free of rocks and debris. The filling should be compacted by hand with a tamping device, ensuring that the soil is forced under the pipe, and it should continue until a level of compacted fill 6" to 12" above the top of the pipe is achieved. This process should be performed in gradual, consistent steps of approximately a 4" layer of fill at any

one time to avoid the arching effect of the soil. When this procedure is accomplished, the final backfill can proceed. With a soil that is free of large rocks or other solids, the final fill can be accomplished.



Figure G-33. Example of underground installation

The piping location should be accurately recorded at this point, and it is suggested to place a conductive wire or shield in the vicinity in order to locate the piping at a later date by the use of an underground metal detector. This will ensure that piping can still be located if the installation plans are misplaced.

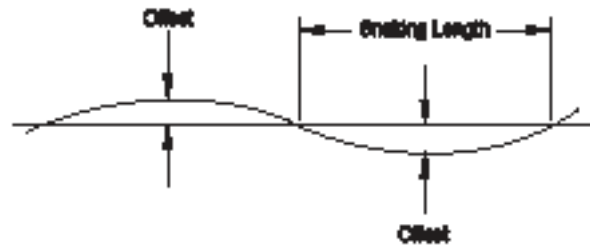

Figure G-34. Illustration of terms relating to snaking of pipe within a trench

Filling the System

The piping should be capped off at the end of the spool section to be tested and fitted with an adapter to allow tie-in for testing. All flanges in the vertical position should be left open at this point. Bleed off air through the relief valves.

Introduce water very slowly into the system at the low point. In no instance should the water velocity exceed two feet per second. When the water fills all vertical risers, the flanges can be resealed. The relief valves should be left open until it is certain that all air is out of the system.

The system can then be brought up to pressure through

gradual steps using a hand pump or other similar equipment.

Do not use city water pressure to accomplish this step if the water pressure in the city mains is greater than the pressure test to be conducted.

Conducting the Test

The test should be done in gradual steps of 10psi for Pro 150/PE 150, 5psi for Pro 45/PE 45, or 10psi for PVDF until the desired pressure is achieved. There will be some gradual drop in pressure due to natural creep effects and elongation of the pipe wall. Also, there could be some drop occurring due to thermal expansion effects where there are sudden environmental temperature changes.

After one hour, check the pressure gauge. If there is a decrease without an indication of leakage, pump the pressure back up to the test pressure. If the total pressure drops more than 10 percent after the second pressurization, the test can be considered a failed test. Check the system for leaks or other problems. Otherwise, continue the pressure test for a minimum of two hours up to a recommended duration of 12 hours, or as required by local code requirements.

Cyclic Hydrostatic Testing

In critical applications, the inner piping should be tested hydrostatically for more than one cycle. To test for more than one cycle, do not empty the system and start over. Instead, drop the system pressure down to below 5psi, and then raise it back to the desired test pressure in gradual steps of 10 to 20psi. Follow the same procedures as previously described. Repeat this procedure for as many cycles as required up to a maximum recommendation of seven cycles.

Note: Do not use fabricated drainage fittings in pressurized systems where a pressure over 10 feet of head is required. Use molded pressure fittings in these applications.

Carrier Pipe, Drainage Systems

Inner piping that is intended for drainage service (10 feet of head or less) should be tested by implementing a 10-foot standing water test. A 10-foot standing water test consists of welding or attaching in some manner a 10-foot riser to the upstream (high end) of the system. It is not unusual for there to be several high points (branch connections) in a system. It is important that every riser or branch connection be affixed with a 10-foot riser in

order to ensure that every point in the system will see 10 feet of head. In fact, at the low point, the system will see a pressure equal to 10 feet of head plus the value of the elevation change. A maximum of 20 feet of head must not be exceeded in a drainage system.

To consider a standing water test acceptable, the water level after 12 hours should be at a level equal to the level at the start of the test, minus normal evaporation and expansion due to temperature fluctuations. Compressed air or gas should not be used for pressure testing of any carrier pipe in excess of 10psi.

Containment Pipe, Pressure Systems

If outer piping is designed and required to withstand the same pressure as the inside piping, then a hydrostatic pressure test should be conducted for both inner and outer pipes. This is for situations where the inner pipe pressure is greater than 10 psi. It is important to remember that when the annular space is pressurized during this situation, two pipes are involved. A plastic pipe is always less capable of withstanding external pressure than internal pressure. The inner pipe should be kept full of water at a pressure equal to the pressure test of the outer pipe.

Equal pressure on the carrier and containment is necessary for the following reasons:

1. To prevent possible collapse of the inner piping during the test.
2. Both the inner and outer piping will elongate equally, therefore minimizing any differential stress or stress buildup between the two pipes.
3. In the event of a carrier failure, the containment piping must handle the same pressure as the carrier. The inner pipe will continue to pressurize the outer pipe until the two reach an equilibrium.

Filling the System

The outer piping can be filled after the inner test is conducted or at the same time as the inner pipe. The system should be filled in the exact same way as described for pressurized carrier pipe.

Do not use city water pressure to accomplish this step if the water pressure in the city mains is greater than the pressure test to be conducted.

In many cases, it is not an advantage to conduct a

hydrostatic test on the annular space, as it is very difficult to dry the space after the test. An air test can be used as an alternative. The pressure should be no higher than 10psi, and extra safety precautions must be made for surrounding personnel. In all cases, the ambient temperature should be above 32°F (0°C). The carrier pipe should also be filled with water and pressurized any time a test is conducted on the annular space.

Conducting the Test

Testing is conducted on the containment in the same manner as the carrier. The test should be done in gradual steps of 10psi for Pro 150/PE 150 or 5psi for Pro 45/PE 45 until the desired test pressure is achieved. There will be some gradual drop in pressure due to natural creep effects and elongation of the pipe wall. Also, there could be some drop occurring due to thermal expansion effects where there are sudden ambient changes.

After one hour, check the pressure gauge. If there is a decrease without an indication of leakage, pump the pressure back up to the test pressure. If the total pressure drops more than 10 percent after this second pressurization, the test can be considered a failed test. Check the system for leaks or other problems. In larger systems and pipelines exposed to large changes in temperature, it may take several tries to get the pressure to remain constant. Otherwise, continue the pressure test for a minimum of two hours up to a recommended duration of 12 hours. A cyclic hydrostatic test as described previously for the inner pipes may be used where appropriate.

Note: Do not use fabricated drainage fittings in pressurized systems where a pressure exceeding 10 feet of head is required. Use molded pressure fittings in these applications.

Containment Pipe, Drainage Systems

Outer piping that is intended for drainage capability (10 feet of head or less) or that is flowing open-end should be tested by implementing a 10-foot standing water test. It should be noted that the carrier pipe pressure must be maintained equal to the outer pipe pressure at all points in order to prevent the inner pipe from collapsing. Pro 45/PE 45 inside carrier pipe is common in some large-diameter systems, such as drainage mains. In order to test these systems, special consideration must be given to ensure that the inner pipe is kept under equal

pressure with the outer pipe.

The standing water test should be conducted in the same manner as the inside pipes. A riser should be attached to every vertical riser equal to 10 feet, and the system should be filled with water. The level should be checked after 12–18 hours. If no fluid has escaped (minus normal evaporative losses and expansion due to temperature fluctuation), the test should be considered successful. It should be noted that the total of the change in elevation plus 10 feet should not exceed the sum of 20 feet.

In order to avoid trapping fluid in the annular space, a low-pressure compressed air or nitrogen test (≤ 10 psi) may be used. Note that if this type of test is used, the carrier inner pipe must be filled with fluid and kept to at least the level of the pressure in the annular space to prevent collapse. If this type of test is used, it is required to “soap” each joint thoroughly to check for visual leaks. In addition, the pressure gauge must also be checked after 2–12 hours for indication. Again, any time compressed air is used, extra safety precautions should be taken. Air tests should be done at 32° F (0°C) or higher ambient temperature.

Annular Test, Drainage Systems

The purpose of the annular test is to test both the carrier and containment simultaneously. For low-pressure drainage systems, an annular test can be conducted to reduce test time. This type of test can only be used on drainage systems using a Pro150 carrier.

Cap off the carrier and containment pipe, and provide a pressure gauge on each. Using low-pressure compressed air (≤ 10 psi), charge the annular space. In a tight system, the containment gauge should read 10psi (minus losses due to creep), and the carrier gauge should be zero. If there is a leak in the containment piping, the containment gauge will begin to drop. However, if there is a leak in the carrier piping, the inner piping will become pressurized. See Figure F-98 for typical test results. Pressure should be maintained on the system for 2–12 hours to ensure against a possible slow leak.

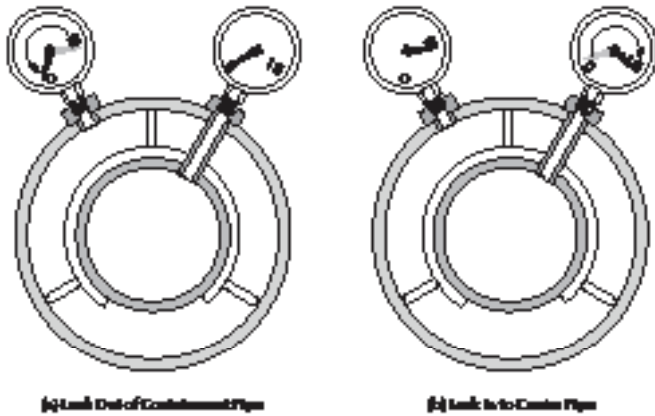

Figure G-35. Annular pressure test leak indications

SYSTEM TABLES

Contents

Physical Properties	App. A-2	Dimensional Pipe Data	App. A-9
Pressure Ratings	App. A-2		
External Support Spacing: Single Wall Pipe ...	App. A-2	Vacuum Rating	App. A-10
Long-Term Modulus of Elasticity	App. A-2	Heat Loss per Linear Foot	App. A-11
PP, PVDF, E-CTFE, HDPE	App. A-2	Purad PVDF	App. A-11
Bending Radius	App. A-3	Proline Pro 150	App. A-12
Single Wall, Double Wall	App. A-3	Proline Pro 45	App. A-13
		Spiral Factor/Pitch	App. A-13
Burial Data	App. A-4	Valve Heat Loss Factor	App. A-13
Max. Allowable Soil Load:	App. A-4	Heat Gain per Linear Foot	App. A-14
Pro 150, Pro 45, PVDF, Duo-Pro	App. A-4	Pro 150 in Still Air	App. A-14-18
Max. Allowable Soil Load: Double Wall Pipe .	App. A-4	Pro 150 in Moving Air	App. A-19-23
Fluid-Lok, Poly-Flo	App. A-4	Pro 45 in Still Air	App. A-24-27
		Pro 45 in Moving Air	App. A-28-30
Fluid Dynamics	App. A-5		
Pressure Drop Versus Flow: Single Wall Pipe .	App. A-5		
Pro 150	App. A-5		
Pro 45	App. A-6		
PVDF	App. A-7		
Poly-Flo	App. A-8		
Eq. Length of Fittings: Single & Double Wall ...	App. A-9		
Proline and Duo-Pro, Poly-Flo, Air-Pro ...	App. A-9		

Please see product specifications on www.asahi-america.com for permissible operating pressures and support spacing information.

Table App. A-14. Long-Term Modulus of Elasticity (psi)

Temperature (° F)	PP	PVDF	Halar®	HDPE
73	26,100	98,000	88,000	30,000
100	21,025	87,000	78,300	—*
140	16,025	54,000	48,600	—*
180	10,000	40,000	36,000	NA
200	NA	31,000	28,000	NA
240	NA	25,000	22,500	NA
280	NA	17,000	15,000	NA

* For conservative estimate use value @ 73° F.



Table App. A-15. Allowable Bending Radius-Proline Polypropylene (inches)

Proline	20° C (68° F)	0° C (32° F)
Pro 150 (SDR 11)	30 x Outside Diameter	75 x Outside Diameter
Pro 90 (SDR 17)	30 x Outside Diameter	75 x Outside Diameter
Pro 45 (SDR 33)	60 x Outside Diameter	150 x Outside Diameter

Table App. A-16. Allowable Bending Radius-Double Wall (inches)

Size	PRO 150 x 45	PRO 150 x 150	PRO 45 x 45	PVDF x PVDF	PVDF x PRO 150	PVDF X PRO 45
1 x 3	NA	608	NA	669	608	NA
2 x 4	744	744	NA	818	744	744
3 x 6	1081	1081	1081	1198	1081	1081
4 x 8	1352	1352	1352	1186	1352	1352
6 x 10	1691	1691	1691	1858	1691	1691
8 x 12	2131	2131	2131	2342	2131	2131
10 x 14	2402	2402	2402	NA	NA	NA
12 x 16	2707	2707	2707	NA	NA	NA
14 x 18	3045	NA	3045	NA	NA	NA
16 x 20	3384	NA	3384	NA	NA	NA
18 x 24	4262	NA	4262	NA	NA	NA
20 x 24	4262	NA	4262	NA	NA	NA

A

Table App. A-17. Max Allowable Soil Load for PP, PVDF, and Duo-Pro* (lbs per linear ft)

Size	Material	Soil Modulus (E')			
		200 psi	400 psi	700 psi	1000 psi
2	Pro 150	749	847	995	1144
	Pro 45	138	251	422	592
	PVDF	386	495	659	824
2.5	Pro 150	897	1015	1191	1367
	Pro 45	165	300	502	704
	PVDF	245	379	581	782
3	Pro 150	1047	1189	1400	1612
	Pro 45	196	358	601	844
	PVDF	270	432	675	918
4	Pro 150	1272	1445	1704	1963
	Pro 45	243	440	737	1034
	PVDF	341	538	835	1132
6	Pro 150	1870	2121	2497	2874
	Pro 45	349	637	1069	1500
	PVDF	484	772	1204	1635
8	Pro 150	2319	2633	3104	3576
	Pro 45	435	795	1336	1876
	PVDF	599	959	1499	2040
10	Pro 150	2913	3305	3894	4483
	Pro 45	546	996	1671	2346
	PVDF	754	1204	1880	2555
12	Pro 150	3657	4151	4894	4636
	Pro 45	687	1254	2105	2957
	PVDF	948	1515	2367	3218
14	Pro 150	4106	4664	5501	6338
	Pro 45	776	1415	2375	3334
16	Pro 150	4625	5254	6197	7140
	Pro 45	870	1591	2673	3754
18	Pro 150	5219	4926	6987	8047
	Pro 45	981	1792	3008	4225
20	Pro 45	1088	1989	3341	4693
24	Pro 45	1376	2511	4213	5914

Table App. A-18. Maximum Allowable Soil Load for Fluid-Lok Double Containment HDPE Pipe

SDR	Max Burial Depth, ft in dry soil of 100 lbs/cu ft			Max External Pressure, psi			Max Deflection, % after installation		
	Soil Modulus, psi*			Soil Modulus, psi*			Soil Modulus, psi*		
	1000	2000	3000	1000	2000	3000	1000	2000	3000
32.5	25	32	37	17	22	26	1.7	0.9	0.6
26.0	33	45	52	23	31	36	2.3	1.2	0.8
21.0	46	61	71	32	42	49	3.2	1.6	1.1
19.0	52	69	81	36	48	56	3.6	1.8	1.2
17.0	61	121	181	42	84	126	4.2	2.1	1.4
15.5	56	112	168	39	78	117	3.9	2.0	1.3
13.5	49	98	147	34	68	102	3.4	1.7	1.1
11.0	39	78	117	27	54	81	2.7	1.4	0.9
9.3	33	68	101	23	47	70	2.3	1.2	0.8
8.3	30	61	89	21	42	62	2.1	1.1	0.7
7.3	26	52	79	18	36	55	1.8	0.9	0.6

Table App. A-19. Maximum Allowable Soil Load for Poly-Flo Pipe (lbs per linear ft)

Size	Soil Modulus (E')			
	200 (psi)	400 (psi)	700 (psi)	1000 (psi)
1 x 2	399	449	524	599
2 x 3	749	847	995	1144
4 x 6	1047	1189	1400	1612

Table App. A-21. Proline Pro 45 Velocities and Pressure Drops

Flow Rate (gpm)	2		2 1/2		3		4		6		7		10		12		14		16		18		20		24		
	V	P	V	P	V	P	V	P	V	P	V	P	V	P	V	P	V	P	V	P	V	P	V	P	V	P	
5	0.38	0.01																									
7	0.53	0.03	0.37	0.01																							
10	0.76	0.05	0.53	0.02	0.37	0.01																					
15	1.13	0.10	0.80	0.05	0.55	0.02																					
20	1.51	0.18	1.07	0.08	0.74	0.03	0.50	0.01																			
25	1.89	0.27	1.34	0.12	0.92	0.05	0.62	0.02																			
30	2.27	0.38	1.60	0.16	1.11	0.08	0.74	0.03																			
35	2.64	0.51	1.87	0.22	1.29	0.09	0.87	0.03																			
40	3.02	0.65	2.14	0.28	1.48	0.11	0.99	0.04																			
45	3.40	0.81	2.40	0.35	1.66	0.14	1.12	0.05																			
50	3.78	0.99	2.67	0.42	1.84	0.17	1.24	0.06																			
60	4.53	1.38	3.20	0.59	2.22	0.24	1.49	0.09	0.70	0.01																	
70	5.29	1.84	3.74	0.79	2.59	0.32	1.74	0.12	0.82	0.02																	
80	6.04	2.35	4.27	1.03	2.96	0.41	1.99	0.16	0.94	0.03																	
90	6.80	2.93	4.80	1.26	3.33	0.52	2.23	0.19	1.05	0.03																	
100	7.55	3.56	5.34	1.53	3.69	0.62	2.48	0.24	1.17	0.04																	
125	9.44	5.38	6.88	2.34	4.62	0.94	3.10	0.36	1.46	0.08	0.93	0.01															
150			8.01	3.24	5.54	1.33	3.72	0.50	1.76	0.08	1.12	0.03															
175			9.35	4.31	6.47	1.76	4.34	0.67	2.05	0.11	1.31	0.03	0.84	0.01													
200			10.68	5.53	7.39	2.26	4.96	0.86	2.34	0.14	1.50	0.03	0.96	0.02													
250					9.24	3.41	6.20	1.29	2.93	0.21	1.87	0.05	1.20	0.02													
300					11.08	4.78	7.44	1.81	3.51	0.29	2.24	0.07	1.44	0.03													
350							8.68	2.42	4.10	0.39	2.62	0.10	1.68	0.04	1.06	0.01											
400							9.93	3.09	4.68	0.50	2.99	0.13	1.92	0.06	1.21	0.02											
450							11.17	3.84	5.27	0.62	3.37	0.16	2.16	0.07	1.36	0.02	1.07										
500									5.85	0.75	3.74	0.19	2.40	0.09	1.51	0.03	1.19	0.02									
600									7.02	1.05	4.49	0.26	2.87	0.12	1.81	0.04	1.43	0.02	1.12	0.01							
700									8.19	1.40	5.24	0.36	3.35	0.15	2.11	0.05	1.66	0.03	1.31	0.02							
800									9.36	1.79	5.98	0.45	3.83	0.20	2.41	0.08	1.90	0.04	1.50	0.02							
900									10.53	2.23	6.73	0.56	4.31	0.26	2.71	0.08	2.14	0.05	1.68	0.03	1.30	0.01					
1,000									11.70	2.71	7.48	0.68	4.79	0.31	3.02	0.10	2.38	0.06	1.87	0.03	1.48	0.02	1.20	0.01			
2,000											14.96	2.47	9.58	1.11	6.03	0.36	4.75	0.20	3.74	0.11	2.96	0.06	2.39	0.04	1.51	0.01	
2,500													11.96	1.68	7.54	0.55	5.94	0.31	4.67	0.17	3.69	0.10	2.99	0.06	1.89	0.02	
5,000																	11.88	1.10	9.35	0.61	7.39	0.35	5.98	0.21	3.77	0.07	
7,500																			14.00	0.30	11.00	0.74	8.97	0.44	5.66	0.14	
10,000																					14.80	1.26	12.00	0.75	7.55	0.24	

V = Velocity of water in ft/s; P = Pressure drop in psi/100 ft of pipe based upon the Hazen and Williams method, using C = 150 in Equation C-20.



Table App. A-22. Purad PVDF Velocities and Pressure Drops

Flow Rate (gpm)	1/2		3/4		1		1 1/4		1 1/2		2		2 1/2		3		4		6		8		10		12		
	V	P	V	P	V	P	V	P	V	P	V	P	V	P	V	P	V	P	V	P	V	P	V	P	V	P	
1	1.01	0.38	0.58	0.1	0.36	0.03	0.21	0.01																			
2	2.02	1.36	1.17	0.37	0.71	0.11	0.42	0.03	0.27	0.01																	
5	5.06	7.42	2.92	2.01	1.78	0.60	1.06	0.17	0.67	0.06	0.41	0.02															
7	7.09	13.80	4.09	3.74	2.49	1.11	1.49	0.32	0.94	0.10	0.57	0.03	0.38	0.01													
10	10.13	26.80	5.84	7.24	3.55	2.16	2.12	0.62	1.35	0.20	0.81	0.06	0.54	0.02													
15			8.76	15.30	5.33	4.57	3.19	1.31	2.02	0.43	1.22	0.13	0.81	0.05	0.40	0.01											
20			11.70	26.10	7.10	7.79	4.25	2.24	2.89	0.74	1.82	0.21	1.07	0.08	0.60	0.02											
25					8.88	11.80	5.31	3.37	3.37	1.11	2.03	0.32	1.34	0.12	0.79	0.04	0.50	0.01									
30					10.70	16.50	6.37	4.73	4.04	1.46	2.43	0.45	1.61	0.17	0.99	0.06	0.62	0.02									
35							7.43	6.30	4.71	2.08	2.84	0.60	1.88	0.22	1.19	0.08	0.74	0.03									
40							8.50	8.06	5.38	2.66	3.24	0.78	2.15	0.29	1.39	0.11	0.87	0.03									
45							9.56	10.00	6.06	3.31	3.65	0.96	2.42	0.36	1.59	0.14	0.99	0.04									
50							10.62	12.20	6.73	4.02	4.05	1.17	2.69	0.43	1.79	0.17	1.12	0.05									
60									8.08	5.63	4.86	1.64	3.22	0.60	1.99	0.21	1.24	0.06	0.70	0.02							
70									9.42	7.49	5.67	2.18	3.76	0.80	2.38	0.29	1.49	0.09	0.82	0.02							
80									10.80	9.60	6.48	2.79	4.30	1.03	2.78	0.39	1.74	0.12	0.94	0.03							
90											7.29	3.47	4.83	1.28	3.18	0.49	1.99	0.16	1.05	0.03							
100											8.10	4.22	5.37	1.55	3.57	0.61	2.23	0.19	1.17	0.04	0.75	0.01					
125											10.13	6.38	6.71	2.35	4.96	0.74	2.48	0.24	1.46	0.06	0.93	0.02					
150													8.06	3.29	5.96	1.13	3.10	0.36	1.76	0.08	1.12	0.03					
175													9.40	4.37	6.95	1.58	3.72	0.50	2.05	0.10	1.31	0.03	0.96	0.01			
200													10.70	5.60	7.94	2.10	4.34	0.85	2.34	0.14	1.50	0.04	1.20	0.02			
250															11.90	9.06	6.20	1.81	2.93	0.21	1.87	0.07	1.44	0.03			
300																	7.44	2.41	3.51	0.29	2.24	0.10	1.68	0.04			
350																	9.93	3.09	4.10	0.39	2.62	0.13	1.92	0.06	1.06	0.01	
400																	11.20	3.84	4.68	0.49	2.99	0.16	2.16	0.07	1.21	0.02	
450																			5.27	0.61	3.37	0.20	2.40	0.08	1.36	0.02	
500																			5.85	0.75	3.74	0.25	2.87	0.12	1.51	0.03	
600																			7.02	1.05	4.49	0.35	3.35	0.16	1.81	0.05	
700																			8.19	1.40	5.24	0.47	3.83	0.20	2.11	0.03	
800																			9.36	1.79	5.98	0.60	4.31	0.26	2.41	0.06	
900																			10.50	2.23	6.73	0.75	4.79	0.31	2.71	0.08	
1000																					7.48	0.91	9.58	1.11	3.02	0.10	
2000																					15.00	3.29	12.00	1.68	6.03	0.36	
2500																										7.54	1.97
5000																										15.10	1.97

V = Velocity of water in ft/s; P = Pressure drop in psi/100 ft of pipe based upon the Hazen and Williams method, using C = 150 in Equation C-20.

Table App. A-23. Poly-Flo Friction Losses and Pressure Drops (per 100 ft of pipe)*

Flow (gpm)	1 x 2		2 x 3		4 x 6	
	Friction Loss (ft of water)	Pressure Drop (psi)	Friction Loss (ft of water)	Pressure Drop (psi)	Friction Loss (ft of water)	Pressure Drop (psi)
1	0.10	0.04				
2	0.37	0.16				
3	0.78	0.34				
5	2.00	0.87				
7	3.73	1.61	0.13	0.06		
10	7.21	3.12	0.25	0.11		
15	15.29	6.62	0.54	0.23		
20	26.04	11.27	0.92	0.40		
25	39.37	17.04	1.38	0.60	0.05	0.02
35	73.42	37.78	2.58	1.12	0.09	0.04
50	142.14	61.53	4.99	2.16	0.17	0.07
75			10.58	4.58	0.36	0.16
100			18.03	7.80	0.62	0.27
150			38.20	16.54	1.31	0.57
250			98.38	42.59	3.37	1.46
500					12.18	5.27
750					25.82	11.18
1000					43.98	19.04
1250					66.49	28.78
1500					93.20	40.34

*Note: Units shown are for specific gravities of working fluids less than or equal to 1.0. Correction factors for more dense fluids are as follows: 0.90 for SG = 1.25, 0.85 for SG = 1.50, 0.75 for SG = 1.75, 0.70 for SG = 2.00.

Table App. A-24. Poly-Flo Pressure Drops (per 100 ft of pipe)

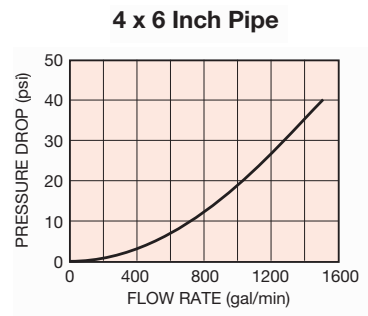
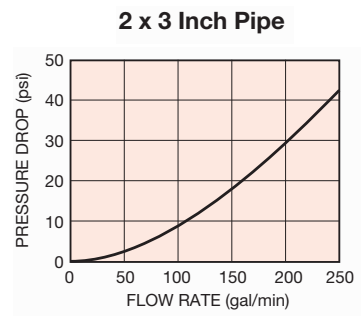
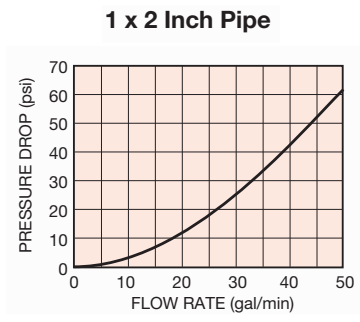

Table App. A-25. Equivalent Lengths for Proline and Duo-Pro Fittings (for friction loss in ft)

Carrier Size (nom in)	90° Elbow	45° Elbow	Tee	Concentric Reduction = D_2/D_1^*			Concentric Reduction = D_1/D_2^{**}		
				1/4	1/2	3/4	1/4	1/2	3/4
1/2	1.50	0.80	3.25				4.0	2.00	1.33
3/4	2.00	1.00	4.00				1.5	1.00	
1	2.75	1.25	6.00		1.0	0.6	2.0	1.50	0.50
1 1/4	3.50	1.70	8.00				3.0	1.75	
1 1/2	4.25	2.00	9.00		1.5			2.20	
2	5.50	2.50	12.00	2.5	2.0	1.2	4.0	2.50	1.00
2 1/2	7.00	3.00	14.00		2.5		6.0	3.50	
3	8.00	3.80	17.00	4.0	3.0		7.0		
4	11.00	5.00	21.00	5.0	4.0	2.5	8.0	5.00	2.00
6	16.00	7.50	34.00	7.0	6.0		12.0	7.00	
8	20.00	10.00	44.00	10.0	8.0	4.0		10.00	4.00
10	25.00	12.50	55.00	12.5	10.0	6.0		12.50	
12	32.00	15.00	58.00	15.0	12.0	7.0			
14	25.00	12.00	80.00						7.00
16	30.00	15.00	90.00	20.0	16.0	9.0			
18	32.50	16.00	100.00						
20	35.00	17.00	110.00						
24	40.00	20.00	140.00						

* D_2 = larger diameter portion, which is shown in size column.

** D_1 = smaller diameter portion, which is shown in size column.

Table App. A-26. Equivalent Lengths for Poly-Flo Fittings (for friction loss in ft)

Description	Equivalent Length (feet)		
	1 x 2	2 x 3	4 x 6
90° Elbow	5.0	10.0	N/A
90° Elbow, Long Sweep	N/A	8.6	12.4
45° Elbow	1.7	4.3	6.2
Tee, Side Outlet	4.0	8.0	16.0
Tee, Straight Flow	1.5	3.0	6.0

Table App. A-27. Equivalent Lengths for Air-Pro Fittings (for friction loss in ft-in)

Description	Nominal Diameter (in.)						
	1/2	3/4	1	1 1/4	1 1/2	2	3
Socket	0'-8"	0'-8"	0'-11"	1'-4"	1'-8"	2'-0"	3'-7"
45° Elbow	0'-8"	0'-11"	1'-4"	2'-0"	3'-0"	4'-0"	7'-6"
90° Elbow	1'-4"	2'-4"	3'-4"	4'-3"	5'-11"	7'-6"	14'-9"
Tee	2'-7"	4'-7"	6'-3"	7'-10"	9'-2"	12'-5"	24'-7"
Reducer	0'-11"	1'-4"	1'-8"	2'-0"	2'-4"	3'-0"	6'-10"

Please see product dimensional guides or BIM catalog on www.asahi-america.com for pipe dimensions.

Table App. A-37. Collapse Pressures

Pro 150 (SDR 11)		Pro 45 (SDR 32.5)		Pro 30 (SDR 41)		HDPE 150 (SDR 11)		PVDF	
° F/° C	(psi)	° F/° C	(psi)	° F/° C	(psi)	° F/° C	(psi)	° F/° C	(psi)
68/20	32.3	68/21	1.2	68/22	0.73	68/23	28.5	68/24	17.4
83/30	28.9	83/31	1.1	83/32	0.66	83/33	24.0	83/34	34.0
104/40	25.5	104/41	1.0	104/42	0.58	104/43	19.7	104/44	7.3
140/60	18.7	140/61	0.7	140/62	0.44	140t63	—	140/64	3.6
176/80	—	176/81	—	176/82	0.29	176/83	—	176/84	2.9
200/93.3	—	200/93.4	—	200/93.5	0.21	200/93.6	—	200/93.7	2.6
—	—	—	—	248/120	—	248/121	—	248/122	2.5

Full vacuum = 14.7 psi, values greater are considered full vacuum.



Table App. A-38. PVDF Pipe Heat Loss in Watts per Linear Foot

n.i.t.	ΔT	Nominal Diameter of Pipe In Inches													
		0.375	0.5	0.75	1	1.25	1.5	2	2.5	3	4	6	8	10	12
0.5	50	1.98	2.26	2.64	3.13	3.75	4.41	5.33	6.29	7.31	8.58	11.62	13.92	16.57	19.78
	75	2.96	3.39	3.97	4.70	5.62	6.61	8.00	9.43	10.97	12.87	17.43	20.80	24.85	29.67
	100	3.95	4.52	5.29	6.27	7.49	8.82	10.67	12.58	14.62	17.16	23.24	27.85	33.14	39.57
	125	4.94	5.66	6.61	7.83	9.36	11.02	13.33	15.72	18.28	21.46	29.05	34.80	41.43	49.46
	150	5.93	6.79	7.93	9.40	11.24	13.23	16.00	18.86	21.94	25.75	34.86	41.78	49.72	59.36
	175	6.92	7.92	9.25	10.97	13.11	15.43	18.67	22.01	25.60	30.04	40.68	48.70	58.01	69.25
1.0	200	7.90	9.05	10.58	12.54	14.98	17.64	21.34	25.15	29.26	34.33	46.49	55.71	66.30	79.15
	50	1.37	1.54	1.75	2.03	2.37	2.74	3.25	3.75	4.32	5.04	6.78	8.14	9.75	11.76
	75	2.05	2.3	2.63	3.05	3.55	4.12	4.88	5.63	6.48	7.56	10.17	12.21	14.62	17.64
	100	2.73	3.07	3.5	4.06	4.74	5.49	6.50	7.51	8.64	10.08	13.56	16.27	19.50	23.53
	125	3.42	3.84	4.38	5.08	5.92	6.86	8.13	9.39	10.80	12.60	16.96	20.30	24.37	29.41
	150	4.10	4.61	5.25	6.09	7.11	8.23	9.76	11.26	12.96	15.11	20.35	24.41	29.25	35.29
1.5	175	4.79	5.37	6.13	7.11	8.29	9.6	11.38	13.14	15.12	17.63	23.74	28.40	34.13	41.17
	200	5.47	6.14	7.00	8.12	9.48	10.98	13.01	15.02	17.28	20.15	27.13	32.55	39.00	47.06
	50	1.13	1.26	1.41	1.61	1.85	2.12	2.48	2.82	3.22	3.72	4.95	5.90	7.07	8.53
	75	1.70	1.88	2.12	2.42	2.78	3.18	3.72	4.24	4.83	5.59	7.43	8.87	10.61	12.80
	100	2.26	2.51	2.82	3.23	3.71	4.24	4.96	5.65	6.44	7.45	9.91	11.83	14.15	17.07
	125	2.83	3.14	3.53	4.04	4.64	5.30	6.20	7.06	8.05	9.31	12.38	14.79	17.68	21.34
2.0	150	3.39	3.77	4.23	4.84	5.56	6.37	7.44	8.47	9.66	11.17	14.86	17.75	21.22	25.60
	175	3.96	4.39	4.94	5.65	6.49	7.43	8.68	9.89	11.27	13.04	17.34	20.70	24.76	29.87
	200	4.52	5.02	5.65	6.46	7.42	8.49	9.92	11.3	12.88	14.90	19.82	23.60	28.29	34.14
	50	1.00	1.10	1.23	1.39	1.58	1.79	2.07	2.34	2.64	3.03	3.99	4.74	5.64	6.79
	75	1.50	1.65	1.84	2.08	2.37	2.69	3.10	3.50	3.96	4.55	5.98	7.10	8.46	10.18
	100	2.00	2.20	2.45	2.78	3.16	3.58	4.14	4.67	5.28	6.07	7.98	9.47	11.28	13.58
2.5	125	2.50	2.75	3.07	3.47	3.95	4.48	5.17	5.84	6.6	7.59	9.97	11.84	14.10	16.97
	150	3.00	3.30	3.68	4.17	4.74	5.37	6.21	7.01	7.92	9.10	11.96	14.21	16.92	20.36
	175	3.50	3.86	4.29	4.86	5.53	6.27	7.24	8.17	9.25	10.62	13.96	16.58	19.74	23.76
	200	4.00	4.41	4.91	5.56	6.32	7.16	8.28	9.34	10.57	12.14	15.95	18.94	22.56	27.15
	50	0.92	1.00	1.11	1.25	1.40	1.58	1.81	2.03	2.28	2.61	3.39	4.00	4.75	5.69
	75	1.37	1.50	1.66	1.87	2.11	2.37	2.72	3.05	3.42	3.91	5.08	6.00	7.12	8.54
3.0	100	1.83	2.00	2.22	2.49	2.81	3.16	3.62	4.06	4.57	5.21	6.78	8.00	9.49	11.38
	125	2.29	2.50	2.77	3.11	3.51	3.95	4.53	5.08	5.71	6.51	8.47	10.00	11.87	14.23
	150	2.75	3.01	3.33	3.74	4.21	4.74	5.44	6.09	6.85	7.82	10.17	12.01	14.24	17.08
	175	3.20	3.51	3.88	4.36	4.92	5.53	6.34	7.11	7.99	9.12	11.86	14.01	16.61	19.92
	200	3.66	4.01	4.43	4.98	5.62	6.32	7.25	8.12	9.13	10.42	13.55	16.01	18.98	22.77
	50	0.85	0.93	1.02	1.14	1.28	1.44	1.63	1.82	2.04	2.31	2.98	3.50	4.13	4.94
4.0	75	1.28	1.40	1.54	1.72	1.92	2.15	2.45	2.73	3.06	3.47	4.47	5.25	6.20	7.41
	100	1.71	1.86	2.05	2.29	2.57	2.87	3.27	3.64	4.07	4.62	5.96	7.00	8.27	9.88
	125	2.14	2.33	2.56	2.86	3.21	3.59	4.09	4.55	5.09	5.78	7.45	8.75	10.33	12.35
	150	2.56	2.79	3.07	3.43	3.85	4.31	4.9	5.46	6.11	6.94	8.94	10.50	12.40	14.82
	175	2.99	3.26	3.59	4.01	4.49	5.03	5.72	6.38	7.13	8.09	10.43	12.25	14.47	17.29
	200	3.42	3.72	4.10	4.58	5.13	5.74	6.54	7.29	8.15	9.25	11.91	14.00	16.53	19.76
5.0	50	0.77	0.84	0.91	1.01	1.12	1.24	1.40	1.55	1.72	1.93	2.45	2.86	3.35	3.97
	75	1.16	1.25	1.37	1.52	1.68	1.87	2.10	2.32	2.58	2.90	3.68	4.28	5.02	5.95
	100	1.54	1.67	1.82	2.02	2.24	2.49	2.81	3.10	3.44	3.87	4.90	5.71	6.69	7.94
	125	1.93	2.09	2.28	2.53	2.81	3.11	3.51	3.87	4.30	4.83	6.13	7.14	8.36	9.92
	150	2.31	2.51	2.74	3.03	3.37	3.73	4.21	4.65	5.15	5.80	7.35	8.57	10.04	11.91
	175	2.70	2.92	3.19	3.54	3.93	4.36	4.91	5.42	6.01	6.77	8.58	9.99	11.71	13.89
200	3.08	3.34	3.65	4.04	4.49	4.98	5.61	6.20	6.87	7.74	9.81	11.42	13.38	15.88	

n.i.t. = nominal insulation thickness of foamed elastomer in inches; ΔT = temperature difference between cold fluid and desired maintenance in °F; body of table is in watts per linear foot of pipe. Heat loss values are calculated using Equation C-67). Values are for moving air at 20 mph velocity, assuming no outer cladding.

Table App. A-39. Proline Pro 150 Pipe Heat Loss in Watts per Linear Foot

n.i.t.	ΔT	Nominal Diameter of Pipe In Inches																
		0.375	0.5	0.75	1	1.25	1.5	2	2.5	3	4	6	8	10	12	14	16	18
0.5	50	1.99	2.28	2.65	3.17	3.73	4.37	5.17	5.88	6.75	7.84	10.26	12.01	13.94	16.14	17.36	18.61	19.85
	75	2.98	3.42	3.97	4.76	5.60	6.55	7.76	8.82	10.12	11.76	15.39	18.02	20.91	24.22	26.05	27.91	29.78
	100	3.97	4.56	5.30	6.34	7.47	8.74	10.35	11.77	13.50	15.68	20.52	24.02	27.88	32.29	34.73	37.22	39.71
	125	4.97	5.70	6.62	7.93	9.33	10.92	12.94	14.71	16.87	19.59	25.66	30.03	34.85	40.37	43.42	46.52	49.64
	150	5.96	6.84	7.94	9.52	11.20	13.11	15.53	17.65	20.25	23.51	30.79	36.04	41.82	48.44	52.10	55.93	59.57
1.0	50	1.37	1.54	1.75	2.05	2.36	2.73	3.19	3.61	4.12	4.77	6.30	7.44	8.77	10.37	11.29	12.26	13.28
	75	2.06	2.32	2.63	3.07	3.55	4.09	4.79	5.41	6.17	7.16	9.44	11.17	13.16	15.56	16.94	18.40	19.92
	100	2.74	3.09	3.50	4.09	4.73	5.46	6.39	7.21	8.23	9.54	12.59	14.89	17.55	20.75	22.59	24.53	26.56
	125	3.43	3.86	4.38	5.12	5.91	6.82	7.98	9.01	10.29	11.93	15.74	18.61	21.94	25.93	28.24	30.66	33.20
	150	4.12	4.63	5.26	6.14	7.09	8.19	9.58	10.82	12.35	14.32	18.89	22.33	26.33	31.12	33.88	36.8	39.84
1.5	50	1.13	1.26	1.41	1.62	1.85	2.11	2.44	2.74	3.10	3.58	4.69	5.54	6.55	7.78	8.50	9.28	10.10
	75	1.70	1.89	2.12	2.44	2.78	3.17	3.67	4.11	4.66	5.37	7.03	8.31	9.82	11.67	12.75	13.91	15.15
	100	2.27	2.52	2.83	3.25	3.70	4.23	4.89	5.48	6.21	7.15	9.38	11.08	13.09	15.56	17.00	18.55	20.20
	125	2.84	3.15	3.53	4.06	4.63	5.28	6.11	6.85	7.76	8.94	11.72	13.85	16.36	19.45	21.25	23.19	25.25
	150	3.40	3.78	4.24	4.87	5.56	6.34	7.33	8.22	9.31	10.73	14.07	16.62	19.64	23.34	25.51	27.83	30.30
2.0	50	1.00	1.11	1.23	1.40	1.58	1.78	2.04	2.28	2.56	2.94	3.81	4.49	5.30	6.3	6.89	7.54	8.22
	75	1.50	1.66	1.84	2.10	2.37	2.68	3.07	3.42	3.85	4.40	5.72	6.74	7.95	9.45	10.34	11.30	12.33
	100	2.01	2.21	2.46	2.79	3.15	3.57	4.09	4.55	5.13	5.87	7.63	8.98	10.60	12.6	13.79	15.07	16.44
	125	2.51	2.76	3.07	3.49	3.94	4.46	5.11	5.69	6.41	7.34	9.54	11.23	13.25	15.75	17.24	18.84	20.55
	150	3.01	3.32	3.68	4.19	4.73	5.35	6.13	6.83	7.69	8.81	11.44	13.48	15.90	18.9	20.68	22.61	24.67
2.5	50	0.92	1.01	1.11	1.25	1.40	1.58	1.79	1.99	2.22	2.53	3.26	3.83	4.50	5.35	5.85	6.39	6.98
	75	1.38	1.51	1.66	1.88	2.10	2.36	2.69	2.98	3.34	3.80	4.89	5.74	6.75	8.02	8.77	9.59	10.47
	100	1.83	2.01	2.22	2.50	2.81	3.15	3.59	3.97	4.45	5.07	6.53	7.65	9.01	10.69	11.70	12.79	13.96
	125	2.29	2.51	2.77	3.13	3.51	3.94	4.48	4.97	5.56	6.33	8.16	9.57	11.26	13.36	14.62	15.99	17.46
	150	2.75	3.02	3.33	3.76	4.21	4.73	5.38	5.96	6.67	7.60	9.79	11.48	13.51	16.04	17.54	19.18	20.95
3.0	50	0.86	0.93	1.03	1.15	1.28	1.43	1.62	1.79	1.99	2.25	2.88	3.37	3.95	4.68	5.11	5.59	6.10
	75	1.28	1.40	1.54	1.72	1.92	2.15	2.43	2.68	2.99	3.38	4.32	5.05	5.92	7.01	7.67	8.38	9.15
	100	1.71	1.87	2.05	2.30	2.56	2.86	3.24	3.57	3.98	4.51	5.76	6.73	7.89	9.35	10.22	11.18	12.20
	125	2.14	2.33	2.56	2.88	3.20	3.58	4.05	4.47	4.98	5.64	7.20	8.41	9.87	11.69	12.78	13.97	15.20
	150	2.57	2.80	3.08	3.45	3.85	4.29	4.86	5.36	5.97	6.76	8.64	10.10	11.84	14.03	15.34	16.76	18.31
4.0	50	0.77	0.84	0.91	1.01	1.12	1.24	1.39	1.52	1.69	1.89	2.38	2.76	3.22	3.8	4.14	4.52	4.93
	75	1.16	1.26	1.37	1.52	1.68	1.86	2.09	2.29	2.53	2.84	3.58	4.15	4.83	5.7	6.21	6.78	7.40
	100	1.55	1.67	1.83	2.03	2.24	2.48	2.78	3.05	3.37	3.79	4.77	5.53	6.45	7.6	8.29	9.04	9.87
	125	1.93	2.09	2.28	2.54	2.80	3.10	3.48	3.81	4.21	4.73	5.96	6.91	8.06	9.49	10.36	11.30	12.33
	150	2.32	2.51	2.74	3.04	3.36	3.72	4.17	4.57	5.06	5.68	7.15	8.29	9.67	11.39	12.43	13.57	14.80

n.i.t. = nominal insulation thickness of foamed elastomer in inches; ΔT = temperature difference between cold fluid and desired maintenance in °F; body of table is in watts per linear foot of pipe. Heat loss values are calculated using Equation C-67). Values are for moving air at 20 mph velocity, assuming no outer cladding.



Table App. A-40. Proline Pro 45 Pipe Heat Loss in Watts per Linear Foot

n.i.t.	ΔT	Nominal Diameter of Pipe In Inches												
		2	2.5	3	4	6	8	10	12	14	16	18	20	24
0.5	50	5.61	6.45	7.50	8.85	12.11	14.63	17.59	21.25	23.38	25.72	28.16	30.55	36.15
	75	8.42	9.68	11.25	13.28	18.17	21.95	26.38	31.87	35.07	38.59	42.25	45.83	54.23
	100	11.22	12.90	15.01	17.71	24.23	29.26	35.18	42.50	46.76	51.45	56.34	61.12	72.31
	125	14.03	16.13	18.76	22.14	30.29	36.58	43.98	53.13	58.45	64.32	70.43	76.40	90.39
	150	16.83	19.36	22.51	26.56	36.35	43.90	52.78	63.76	70.15	77.19	84.52	91.69	108.48
1.0	50	3.35	3.81	4.38	5.13	6.95	8.37	10.09	12.27	13.56	15.00	16.54	18.06	21.78
	75	5.03	5.72	6.58	7.70	10.42	12.56	15.14	18.40	20.34	22.50	24.81	27.10	32.68
	100	6.71	7.62	8.77	10.26	13.90	16.75	20.19	24.53	27.13	30.00	33.09	36.13	43.57
	125	8.38	9.53	10.96	12.83	17.37	20.94	25.24	30.67	33.91	37.51	41.36	45.16	54.47
	150	10.06	11.44	13.16	15.39	20.85	25.12	30.28	36.80	40.69	45.01	49.63	54.20	65.36
1.5	50	2.54	2.86	3.26	3.77	5.04	6.04	7.25	8.80	9.73	10.76	11.88	12.99	15.75
	75	3.81	4.29	4.88	5.66	7.56	9.06	10.88	13.19	14.59	16.14	17.82	19.49	23.63
	100	5.07	5.71	6.51	7.55	10.08	12.08	14.51	17.59	19.45	21.52	23.76	25.98	31.51
	125	6.34	7.14	8.14	9.44	12.60	15.10	18.13	21.99	24.32	26.90	29.70	32.48	39.38
	150	7.61	8.57	9.77	11.33	15.13	18.12	21.76	26.39	29.18	32.28	35.65	38.98	47.26
2.0	50	2.11	2.36	2.67	3.07	4.04	4.81	5.75	6.95	7.68	8.49	9.37	10.24	12.43
	75	3.16	3.54	4.00	4.60	6.07	7.22	8.63	10.43	11.52	12.73	14.05	15.36	18.65
	100	4.22	4.72	5.33	6.14	8.09	9.63	11.51	13.91	15.36	16.97	18.73	20.48	24.86
	125	5.27	5.89	6.67	7.67	10.11	12.04	14.39	17.38	19.20	21.22	23.42	25.60	31.08
	150	6.33	7.07	8.00	9.20	12.13	14.44	17.26	20.86	23.04	25.46	28.10	30.72	37.30
2.5	50	1.84	2.05	2.30	2.63	3.43	4.06	4.83	5.80	6.40	7.07	7.79	8.51	10.33
	75	2.76	3.07	3.45	3.95	5.14	6.09	7.24	8.71	9.60	10.60	11.69	12.77	15.49
	100	3.69	4.10	4.60	5.26	6.86	8.12	9.65	11.61	12.81	14.13	15.58	17.02	20.66
	125	4.61	5.12	5.75	6.58	8.57	10.15	12.07	14.52	16.01	17.67	19.48	21.28	25.82
	150	5.53	6.14	6.90	7.89	10.29	12.17	14.48	17.42	19.21	21.20	23.37	25.53	30.99
3.0	50	1.66	1.84	2.05	2.33	3.01	3.54	4.19	5.03	5.53	6.09	6.71	7.32	8.88
	75	2.49	2.75	3.08	3.50	4.52	5.31	6.29	7.54	8.30	9.14	10.07	10.99	13.31
	100	3.32	3.67	4.10	4.66	6.02	7.09	8.39	10.05	11.06	12.19	13.42	14.65	17.75
	125	4.15	4.59	5.13	5.83	7.53	8.86	10.48	12.56	13.83	15.24	16.78	18.31	22.19
	150	4.98	5.51	6.15	7.00	9.03	10.63	12.58	15.08	16.59	18.28	20.13	21.97	26.63
4.0	50	1.42	1.56	1.73	1.95	2.47	2.88	3.38	4.02	4.41	4.85	5.32	5.80	7.00
	75	2.13	2.34	2.59	2.92	3.71	4.33	5.08	6.04	6.62	7.27	7.99	8.70	10.50
	100	2.84	3.12	3.46	3.89	4.95	5.77	6.77	8.05	8.83	9.70	10.65	11.59	14.00
	125	3.55	3.90	4.32	4.87	6.18	7.21	8.46	10.06	11.04	12.12	13.31	14.49	17.50
	150	4.26	4.68	5.19	5.84	7.42	8.65	10.16	12.08	13.24	14.54	15.97	17.39	21.00

n.i.t. = nominal insulation thickness of foamed elastomer in inches; ΔT = temperature difference between cold fluid and desired maintenance in °F; body of table is in watts per linear foot of pipe. Heat loss values are calculated using Equation C-67). Values are for moving air at 20 mph velocity, assuming no outer cladding.

Table App. A-41. Spiral Factor/Pitch

Pipe Size (ips)	Spiral Factor (feet of auto-tractor per feet of pipe)				
	1.1	1.2	1.3	1.4	1.5
1.0	NR	NR	NR	NR	NR
1.5	NR	NR	NR	NR	NR
2.0	17	NR	NR	NR	NR
2.5	20	14	NR	NR	NR
3.0	24	17	13	NR	NR
3.5	28	19	15	13	NR
4.0	31	21	17	14	NR
4.5	35	24	19	16	14
5.0	39	26	21	18	15
6.0	46	31	25	21	18
8.0	59	41	33	28	24

Note: 1 inch = 2.54 cm

Table App. A-42. Valve Heat Loss Factor

Valve Type	Std 90
Gate	4.3
Butterfly	2.3
Ball	2.6
Globe	3.9

For Example: Heat loss for a 2" gate valve is 4.3 times the heat loss for one foot of pipe of the same size and insulation.

Table App. A-43. Heat Gain Values for Pro150 in Still Air Conditions

Nominal Insulation Thickness (inches)	Fluid Temp (F)	Pipe Size = 0.5", O.D. = 0.79"						Pipe Size = 0.75", O.D. = 0.98"						Pipe Size = 1.0", O.D. = 1.26"					
		Ambient Temperature (F)						Ambient Temperature (F)						Ambient Temperature (F)					
		90		85		80		90		85		80		90		85		80	
		Heat Gain	Surface Temp	Heat Gain	Surface Temp	Heat Gain	Surface Temp	Heat Gain	Surface Temp	Heat Gain	Surface Temp	Heat Gain	Surface Temp	Heat Gain	Surface Temp	Heat Gain	Surface Temp	Heat Gain	Surface Temp
0	35	15.8	42.3	14.4	41.5	12.9	41	19.5	42.5	17.7	41.9	15.9	41.3	24.7	43.2	22.5	42.4	20.2	41.7
0.125	35	11.7	63.1	10.7	60.4	9.6	58	14	62.8	12.7	60.4	11.4	57.9	17.2	62.8	15.7	60.2	14.1	57.7
0.25	35	9.5	72.4	8.7	68.9	7.8	65.6	11.2	71.9	10.2	68.5	9.2	65.2	13.6	71.6	12.3	68.3	11.1	64.9
0.375	35	8.2	77.3	7.4	73.5	6.7	69.6	9.5	76.9	8.6	73.1	7.8	69.2	11.4	76.5	10.4	72.6	9.3	69
0.5	35	7.3	80.3	6.6	76.2	5.9	72.1	8.4	79.9	7.6	75.8	6.9	71.7	10	79.4	9.1	75.4	8.2	71.3
0.625	35	6.6	82.3	6	78	5.4	73.7	7.6	81.9	6.9	77.6	6.2	73.4	8.9	81.5	8.1	77.3	7.3	73.1
0.75	35	6.1	83.6	5.5	79.3	5	74.8	6.9	83.4	6.3	78.9	5.7	74.5	8.2	82.9	7.4	78.6	6.7	74.2
1	35	5.4	85.4	4.9	80.8	4.4	76.2	6.1	85.1	5.5	80.6	6	76	7.1	84.8	6.4	80.3	5.8	75.8
1.25	35	4.9	86.4	4.4	81.8	4	77.1	5.5	86.2	5.0	81.6	4.5	76.9	6.3	86	5.7	81.4	5.2	76.7
1.5	35	4.5	87.2	4.1	82.4	3.7	77.7	5	87	4.6	82.2	4.1	77.5	5.8	86.7	5.3	82	4.7	77.4
2	35	4.0	88	3.6	83.2	3.3	78.4	4.4	87.9	4.0	83.1	3.6	78.3	5	87.7	4.6	82.9	4.1	78.1
2.5	35	3.7	88.5	3.3	83.6	3	78.8	4	88.4	3.7	83.5	3.3	78.7	4.6	88.2	4.1	83.4	3.7	78.6
0	40	14.4	46.5	12.9	46	11.5	45.2	17.7	46.9	15.9	46.3	14.2	45.4	22.5	47.4	20.2	46.7	18	45.9
0.125	40	10.7	65.4	9.6	63	8.5	60.5	12.7	65.4	11.4	62.9	10.2	60.2	15.7	65.2	14.1	62.7	12.5	60.2
0.25	40	8.7	73.9	7.8	70.6	6.9	67.2	10.2	73.5	9.2	70.2	8.1	66.9	12.3	73.3	11.1	69.9	9.9	66.6
0.375	40	7.4	78.5	6.7	74.6	5.9	70.9	8.6	78.1	7.8	74.2	6.9	70.5	10.4	77.6	9.3	74	8.3	70.1
0.5	40	6.6	81.2	5.9	77.1	5.3	72.9	7.6	80.8	6.9	76.7	6.1	72.6	9.1	80.4	8.2	76.3	7.2	72.4
0.625	40	6.0	83	5.4	78.7	4.8	74.4	6.9	82.6	6.2	78.4	5.5	74.1	8.1	82.3	7.3	78.1	6.5	73.8
0.75	40	5.5	84.3	5	79.8	4.4	75.4	6.3	83.9	5.7	79.5	5.1	75.1	7.4	83.6	6.7	79.2	5.9	74.9
1	40	4.9	85.8	4.4	81.2	3.9	76.7	5.5	85.6	5.0	81	4.4	76.5	6.4	85.3	5.8	80.8	5.1	76.3
1.25	40	4.4	86.8	4	82.1	3.5	77.5	5	86.6	4.5	81.9	4	77.3	5.7	86.4	5.2	81.7	4.6	77.1
1.5	40	4.1	87.4	3.7	82.7	3.3	77.9	4.6	87.2	4.1	82.5	3.7	77.8	5.3	87	4.7	82.4	4.2	77.6
2	40	3.6	88.2	3.3	83.4	2.9	78.6	4	88.1	3.6	83.3	3.2	78.5	4.6	87.9	4.1	83.1	3.7	78.3
2.5	40	3.3	88.6	3	83.8	2.7	78.9	3.7	88.5	3.3	83.7	2.9	78.8	4.1	88.4	3.7	83.6	3.3	78.7
0	45	12.9	51	11.5	50.2	10.1	49.5	15.9	51.3	14.2	50.4	12.4	49.8	20.2	51.7	18	50.9	15.7	50.3
0.125	45	9.6	68	8.5	65.5	7.5	62.8	11.4	67.9	10.2	65.2	8.9	62.7	14.1	67.7	12.5	65.2	11	62.6
0.25	45	7.8	75.6	6.9	72.2	6.1	68.7	9.2	75.2	8.1	71.9	7.1	68.5	11.1	74.9	9.9	71.6	8.6	68.3
0.375	45	6.7	79.6	5.9	75.9	5.2	71.9	7.8	79.2	6.9	75.5	6	71.7	9.3	79	8.3	75.1	7.3	71.3
0.5	45	5.9	82.1	5.3	77.9	4.6	73.9	6.9	81.7	6.1	77.6	5.3	73.6	8.2	81.3	7.2	77.4	6.3	73.3
0.625	45	5.4	83.7	4.8	79.4	4.2	75.1	6.2	83.4	5.5	79.1	4.8	74.9	7.3	83.1	6.5	78.8	5.7	74.6
0.75	45	5.0	84.8	4.4	80.4	3.9	75.9	5.7	84.5	5.1	80.1	4.4	75.8	6.7	84.2	5.9	79.9	5.2	75.5
1	45	4.4	86.2	3.9	81.7	3.4	77.1	5	86	4.4	81.5	3.9	76.9	5.8	85.8	5.1	81.3	4.5	76.7
1.25	45	4.0	87.1	3.5	82.5	3.1	77.8	4.5	86.9	4	82.3	3.5	77.6	5.2	86.7	4.6	82.1	4	77.5
1.5	45	3.7	87.7	3.3	82.9	2.9	78.2	4.1	87.5	3.7	82.8	3.2	78.1	4.7	87.4	4.2	82.6	3.7	77.9
2	45	3.3	88.4	2.9	83.6	2.6	78.7	3.6	88.3	3.2	83.5	2.8	78.7	4.1	88.1	3.7	83.3	3.2	78.5
2.5	45	3.0	88.8	2.7	83.9	2.3	79.1	3.3	88.7	2.9	83.8	2.6	79	3.7	88.6	3.3	83.7	2.9	78.9
0	50	11.5	55.2	10.1	54.5	8.6	54	14.2	55.4	12.4	54.8	10.6	54.2	18	55.9	15.7	55.3	13.5	54.4
0.125	50	8.5	70.5	7.5	67.8	6.4	65.3	10.2	70.2	8.9	67.7	7.6	65.2	12.5	70.2	11	67.6	9.4	65.1
0.25	50	6.9	77.2	6.1	73.7	5.2	70.4	8.1	76.9	7.1	73.5	6.1	70.2	9.9	76.6	8.6	73.3	7.4	70
0.375	50	5.9	80.9	5.2	76.9	4.5	73	6.9	80.5	6	76.7	5.2	72.8	8.3	80.1	7.3	76.3	6.2	72.6
0.5	50	5.3	82.9	4.6	78.9	4	74.7	6.1	82.6	5.3	78.6	4.6	74.5	7.2	82.4	6.3	78.3	5.4	74.3
0.625	50	4.8	84.4	4.2	80.1	3.6	75.8	5.5	84.1	4.8	79.9	4.1	75.6	6.5	83.8	5.7	79.6	4.9	75.3
0.75	50	4.4	85.4	3.9	80.9	3.3	76.6	5.1	85.1	4.4	80.8	3.8	76.3	5.9	84.9	5.2	80.5	4.5	76.1
1	50	3.9	86.7	3.4	82.1	2.9	77.5	4.4	86.5	3.9	81.9	3.3	77.4	5.1	86.3	4.5	81.7	3.9	77.1
1.25	50	3.5	87.5	3.1	82.8	2.7	78	4	87.3	3.5	82.6	3	77.9	4.6	87.1	4	82.5	3.4	77.8
1.5	50	3.3	87.9	2.9	83.2	2.5	78.4	3.7	87.8	3.2	83.1	2.8	78.3	4.2	87.6	3.7	82.9	3.2	78.2
2	50	2.9	88.6	2.6	83.7	2.2	78.9	3.2	88.5	2.8	83.7	2.4	78.8	3.7	88.3	3.2	83.5	2.8	78.7
2.5	50	2.7	88.9	2.3	84.1	2	79.2	2.9	88.8	2.6	84	2.2	79.1	3.3	88.7	2.9	83.9	2.5	79
0	55	10.1	59.5	8.6	59	7.2	58.2	12.4	59.8	10.6	59.2	8.9	58.3	15.7	60.3	13.5	59.4	11.2	58.8
0.125	55	7.5	72.8	6.4	70.3	5.3	67.8	8.9	72.7	7.6	70.2	6.4	67.6	11	72.6	9.4	70.1	7.8	67.7
0.25	55	6.1	78.7	5.2	75.4	4.3	72	7.1	78.5	6.1	75.2	5.1	71.8	8.6	78.3	7.4	75	6.2	71.6
0.375	55	5.2	81.9	4.5	78	3.7	74.3	6	81.7	5.2	77.8	4.3	74.1	7.3	81.3	6.2	77.6	5.2	73.8
0.5	55	4.6	83.9	4	79.7	3.3	75.6	5.3	83.6	4.6	79.5	3.8	75.4	6.3	83.3	5.4	79.3	4.5	75.2
0.625	55	4.2	85.1	3.6	80.8	3	76.5	4.8	84.9	4.1	80.6	3.4	76.4	5.7	84.6	4.9	80.3	4.1	76.1
0.75	55	3.9	85.9	3.3	81.6	2.8	77.1	4.4	85.8	3.8	81.3	3.2	76.9	5.2	85.5	4.5	81.1	3.7	76.8
1	55	3.4	87.1	2.9	82.5	2.4	77.9	3.9	86.9	3.3	82.4	2.8	77.8	4.5	86.7	3.9	82.1	3.2	77.7
1.25	55	3.1	87.8	2.7	83	2.2	78.4	3.5	87.6	3.0	82.9	2.5	78.3	4	87.5	3.4	82.8	2.9	78.2
1.5	55	2.9	88.2	2.5	83.4	2.1	78.7	3.2	88.1	2.8	83.3	2.3	78.6	3.7	87.9	3.2	83.2	2.6	78.5
2	55	2.6	88.7	2.2	83.9	1.8	79.1	2.8	88.7	2.4	83.8	2	79	3.2	88.5	2.8	83.7	2.3	79
2.5	55	2.3	89.1	2	84.2	1.7	79.3	2.6	89	2.2	84.1	1.8	79.3	2.9	88.9	2.5	84	2.1	79.2

Fluid Temp = temperature of the chilled water (F).
Heat Gain (Btu per linear foot of pipe) calculated from Equation C-67.

Table App A-43. Heat Gain Values for Pro150 in Still Air Conditions (continued)

Nominal Insulation Thickness (inches)	Fluid Temp (F)	Pipe Size = 1.25", O.D. = 1.58"						Pipe Size = 1.5", O.D. = 1.97"						Pipe Size = 2.0", O.D. = 2.48"					
		Ambient Temperature (F)						Ambient Temperature (F)						Ambient Temperature (F)					
		90		85		80		90		85		80		90		85		80	
		Heat Gain	Surface Temp	Heat Gain	Surface Temp	Heat Gain	Surface Temp	Heat Gain	Surface Temp	Heat Gain	Surface Temp	Heat Gain	Surface Temp	Heat Gain	Surface Temp	Heat Gain	Surface Temp	Heat Gain	Surface Temp
0	35	30.1	44.5	27.4	43.6	24.6	42.8	35.8	46.6	32.6	45.5	29.3	44.5	42.8	48.8	38.9	47.6	35	46.3
0.125	35	20.7	63	18.8	60.5	16.9	58	24.5	63.7	22.3	61	20.1	58.4	29.3	64.4	26.6	61.7	24	59
0.25	35	16.1	71.5	14.7	68.1	13.2	64.8	19	71.6	17.3	68.3	15.6	64.9	22.7	71.8	20.6	68.5	18.6	65.1
0.375	35	13.5	76.2	12.2	72.5	11	68.7	15.8	76.1	14.4	72.4	12.9	68.7	18.8	76.1	17.1	72.4	15.4	68.6
0.5	35	11.7	79.2	10.6	75.2	9.6	71.1	13.6	79.1	12.4	75	11.2	71	16.1	79	14.7	74.9	13.2	70.9
0.625	35	10.4	81.2	9.5	77	8.5	72.8	12.1	81	11	76.8	9.9	72.7	14.3	80.8	13	76.7	11.7	72.5
0.75	35	9.5	82.6	8.6	78.3	7.7	74	11	82.4	10	78.1	9	73.8	12.9	82.3	11.7	78	10.5	73.7
1	35	8.1	84.6	7.4	80.1	6.6	75.6	9.4	84.3	8.5	79.9	7.7	75.4	10.9	84.2	9.9	79.7	8.9	75.3
1.25	35	7.2	85.8	6.6	81.1	5.9	76.5	8.3	85.6	7.5	81	6.8	76.4	9.6	85.4	8.7	80.8	7.8	76.3
1.5	35	6.6	86.6	6	81.9	5.4	77.2	7.5	86.4	6.8	81.7	6.1	77.1	8.6	86.3	7.9	81.6	7.1	76.9
2	35	5.7	87.6	5.2	82.8	4.7	78	6.4	87.4	5.8	82.7	5.3	77.9	7.3	87.3	6.7	82.5	6	77.8
2.5	35	5.1	88.1	4.6	83.3	4.2	78.5	5.7	88	5.2	83.2	4.7	78.4	6.5	87.9	5.9	83.1	5.3	78.3
0	40	27.4	48.6	24.6	47.8	21.9	46.9	32.6	50.5	29.3	49.5	26.1	48.4	38.9	52.6	35	51.3	31.1	50.1
0.125	40	18.8	65.5	16.9	63	15	60.4	22.3	66	20.1	63.4	17.8	60.9	26.6	66.7	24	64	21.3	61.4
0.25	40	14.7	73.1	13.2	69.8	11.7	66.6	17.3	73.3	15.6	69.9	13.8	66.7	20.6	73.5	18.6	70.1	16.5	66.8
0.375	40	12.2	77.5	11	73.7	9.8	70	14.4	77.4	12.9	73.7	11.5	69.9	17.1	77.4	15.4	73.6	13.6	69.9
0.5	40	10.6	80.2	9.6	76.1	8.5	72.1	12.4	80	11.2	76	9.9	72	14.7	79.9	13.2	75.9	11.7	72
0.625	40	9.5	82	8.5	77.8	7.6	73.6	11	81.8	9.9	77.7	8.8	73.5	13	81.7	11.7	77.5	10.4	73.3
0.75	40	8.6	83.3	7.7	79	6.9	74.7	10	83.1	9	78.8	8	74.5	11.7	83	10.5	78.7	9.4	74.4
1	40	7.4	85.1	6.6	80.6	5.9	76.1	8.5	84.9	7.7	80.4	6.8	75.9	9.9	84.7	8.9	80.3	7.9	75.8
1.25	40	6.6	86.1	5.9	81.5	5.3	76.9	7.5	86	6.8	81.4	6	76.8	8.7	85.8	7.8	81.3	7	76.6
1.5	40	6	86.9	5.4	82.2	4.8	77.5	6.8	86.7	6.1	82.1	5.4	77.4	7.9	86.6	7.1	81.9	6.3	77.3
2	40	5.2	87.8	4.7	83	4.1	78.2	5.8	87.7	5.3	82.9	4.7	78.1	6.7	87.5	6	82.8	5.3	78
2.5	40	4.6	88.3	4.2	83.5	3.7	78.7	5.2	88.2	4.7	83.4	4.2	78.6	5.9	88.1	5.3	83.3	4.7	78.5
0	45	24.6	52.8	21.9	51.9	19.2	51	29.3	54.5	26.1	53.4	22.8	52.4	35	56.3	31.1	55.1	27.2	53.8
0.125	45	16.9	68	15	65.4	13.2	62.8	20.1	68.4	17.8	65.9	15.6	63.2	24	69	21.3	66.4	18.6	63.7
0.25	45	13.2	74.8	11.7	71.6	10.3	68.2	15.6	74.9	13.8	71.7	12.1	68.3	18.6	75.1	16.5	71.8	14.4	68.5
0.375	45	11	78.7	9.8	75	8.6	71.2	12.9	78.7	11.5	74.9	10	71.2	15.4	78.6	13.6	74.9	11.9	71.2
0.5	45	9.6	81.1	8.5	77.1	7.4	73.2	11.2	81	9.9	77	8.7	73	13.2	80.9	11.7	77	10.3	72.9
0.625	45	8.5	82.8	7.6	78.6	6.6	74.4	9.9	82.7	8.8	78.5	7.7	74.3	11.7	82.5	10.4	78.3	9.1	74.2
0.75	45	7.7	84	6.9	79.7	6	75.3	9	83.8	8	79.5	7	75.2	10.5	83.7	9.4	79.4	8.2	75.1
1	45	6.6	85.6	5.9	81.1	5.2	76.5	7.7	85.4	6.8	80.9	6	76.4	8.9	85.3	7.9	80.8	6.9	76.3
1.25	45	5.9	86.5	5.3	81.9	4.6	77.3	6.8	86.4	6	81.8	5.3	77.2	7.8	86.3	7	81.6	6.1	77.1
1.5	45	5.4	87.2	4.8	82.5	4.2	77.8	6.1	87.1	5.4	82.4	4.8	77.7	7.1	86.9	6.3	82.3	5.5	77.6
2	45	4.7	88	4.1	83.2	3.6	78.5	5.3	87.9	4.7	83.1	4.1	78.4	6	87.8	5.3	83	4.7	78.3
2.5	45	4.2	88.5	3.7	83.7	3.2	78.8	4.7	88.4	4.2	83.6	3.6	78.8	5.3	88.3	4.7	83.5	4.1	78.7
0	50	21.9	56.9	19.2	56	16.4	55.2	26.1	58.4	22.8	57.4	19.5	56.4	31.1	60.1	27.2	58.8	23.3	57.6
0.125	50	15	70.4	13.2	67.8	11.3	65.3	17.8	70.9	15.6	68.2	13.4	65.6	21.3	71.4	18.6	68.7	16	66
0.25	50	11.7	76.6	10.3	73.2	8.8	69.9	13.8	76.7	12.1	73.3	10.4	69.9	16.5	76.8	14.4	73.5	12.4	70.1
0.375	so	9.8	80	8.6	76.2	7.3	72.5	11.5	79.9	10	76.2	8.6	72.5	13.6	79.9	11.9	76.2	10.2	72.5
0.5	50	8.5	82.1	7.4	78.2	6.4	74.1	9.9	82	8.7	78	7.4	74.1	11.7	82	10.3	77.9	8.8	74
0.625	50	7.6	83.6	6.6	79.4	5.7	75.2	8.8	83.5	7.7	79.3	6.6	75.1	10.4	83.3	9.1	79.2	7.8	75
0.75	50	6.9	84.7	6	80.3	5.2	76	8	84.5	7	80.2	6	75.9	9.4	84.4	8.2	80.1	7	75.8
1	50	5.9	86.1	5.2	81.5	4.4	77.1	6.8	85.9	6	81.4	5.1	76.9	7.9	85.8	6.9	81.3	6	76.8
1.25	50	5.3	86.9	4.6	82.3	3.9	77.7	6	86.8	5.3	82.2	4.5	77.6	7	86.6	6.1	82.1	5.2	77.5
1.5	50	4.8	87.5	4.2	82.8	3.6	78.1	5.4	87.4	4.8	82.7	4.1	78	6.3	87.3	5.5	82.6	4.7	78
2	50	4.1	88.2	3.6	83.5	3.1	78.7	4.7	88.1	4.1	83.4	3.5	78.6	5.3	88	4.7	83.3	4	78.5
2.5	50	3.7	88.7	3.2	83.8	2.8	79	4.2	88.6	3.6	83.8	3.1	78.9	4.7	88.5	4.1	83.7	3.5	78.9
0	55	19.2	61	16.4	60.2	13.7	59.3	22.8	62.4	19.5	61.4	16.3	60.2	27.2	63.8	23.3	62.6	19.4	61.3
0.125	55	13.2	72.8	11.3	70.3	9.4	67.7	15.6	73.2	13.4	70.6	11.1	68.1	18.6	73.7	16	71	13.3	68.4
0.25	55	10.3	78.2	8.8	74.9	7.3	71.6	12.1	78.3	10.4	74.9	8.7	71.6	14.4	78.5	12.4	75.1	10.3	71.7
0.375	55	8.6	81.2	7.3	77.5	6.1	73.7	10	81.2	8.6	77.5	7.2	73.7	11.9	81.2	10.2	77.5	8.5	73.7
0.5	55	7.4	83.2	6.4	79.1	5.3	75.1	8.7	83	7.4	79.1	6.2	75	10.3	82.9	8.8	79	7.3	75
0.625	55	6.6	84.4	5.7	80.2	4.7	76	7.7	84.3	6.6	80.1	5.5	75.9	9.1	84.2	7.8	80	6.5	75.8
0.75	55	6	85.3	5.2	81	4.3	76.7	7	85.2	6	80.9	5	76.6	8.2	85.1	7	80.8	5.9	76.5
1	55	5.2	86.5	4.4	82.1	3.7	77.5	6	86.4	5.1	81.9	4.3	77.4	6.9	86.3	6	81.8	5	77.3
1.25	55	4.6	87.3	3.9	82.7	3	78.1	5.3	87.2	4.5	82.6	3.8	78	6.1	87.1	5.2	82.5	4.4	77.9
1.5	55	4.2	87.8	3.6	83.1	3	78.4	4.8	87.7	4.1	83	3.4	78.4	5.5	87.6	4.7	83	3.9	78.3
2	55	3.6	88.5	3.1	83.7	2.6	78.9	4.1	88.4	3.5	83.6	2.9	78.8	4.7	88.3	4	83.5	3.3	78.8
2.5	55	3.2	88.8	2.8	84	2.3	79.2	3.6	88.8	3.1	83.9	2.6	79.1	4.1	88.7	3.5	83.9	3	79

Fluid Temp = temperature of the chilled water (F).
Heat Gain (Btu per linear foot of pipe) calculated from Equation C-67.

Table App A-43. Heat Gain Values for Pro150 in Still Air Conditions (continued)

Nominal Insulation Thickness (inches)	Fluid Temp (F)	Pipe Size = 3.0", O.D. = 3.54"						Pipe Size = 4.0", O.D. = 4.33"						Pipe Size = 6.0", O.D. = 6.29"					
		Ambient Temperature (F)						Ambient Temperature (F)						Ambient Temperature (F)					
		90		85		80		90		85		80		90		85		80	
		Heat Gain	Surface Temp	Heat Gain	Surface Temp	Heat Gain	Surface Temp	Heat Gain	Surface Temp	Heat Gain	Surface Temp	Heat Gain	Surface Temp	Heat Gain	Surface Temp	Heat Gain	Surface Temp	Heat Gain	Surface Temp
0	35	55.3	52.7	50.2	51.1	45.2	49.5	63.1	55.2	57.4	53.4	51.7	51.5	78.5	60.2	71.3	57.9	64.2	55.6
0.125	35	38.4	65.8	34.9	63	31.4	60.2	44.4	66.9	40.4	63.9	36.3	61.1	57.2	69.1	52	66	46.8	62.9
0.25	35	29.8	72.4	27.1	69	24.4	65.6	34.7	72.8	31.5	69.4	28.4	66	45.3	74.1	41.2	70.5	37.1	67
0.375	35	24.6	76.3	22.4	72.5	20.1	68.8	28.7	76.5	26	72.8	23.4	69	37.7	77.2	34.3	73.4	30.9	69.5
0.5	35	21.1	78.9	19.2	74.9	17.3	70.9	24.6	79	22.3	75	20.1	71	32.5	79.4	29.5	75.3	26.6	71.3
0.625	35	18.6	80.7	16.9	76.6	15.2	72.4	21.6	80.8	19.7	76.6	17.7	72.4	28.6	80.9	26	76.8	23.4	72.6
0.75	35	16.7	82.1	15.2	77.8	13.7	73.5	19.4	82.1	17.6	77.8	15.9	73.5	25.7	82.1	23.4	77.8	21	73.6
1	35	14	84	12.8	79.5	11.5	75	16.3	83.9	14.8	79.4	13.3	75	21.5	83.8	19.5	79.4	17.6	74.9
1.25	35	12.2	85.2	11.1	80.6	10	76	14.1	85.1	12.8	80.5	11.6	75.9	18.6	84.9	16.9	80.4	15.2	75.9
1.5	35	10.9	86	9.9	81.4	9	76.7	12.6	85.9	11.4	81.3	10.3	76.6	16.5	85.8	15	81.1	13.5	76.5
2	35	9.2	87.1	8.4	82.3	7.5	77.6	10.5	87	9.6	82.2	8.6	77.5	13.6	86.8	12.4	82.1	11.2	77.4
2.5	35	8.1	87.7	7.3	83	6.6	78.2	9.2	87.6	8.3	82.9	7.5	78.1	11.8	87.5	10.7	82.7	9.6	78
0	40	50.2	56.1	45.2	54.5	40.2	52.9	57.4	58.4	51.7	56.5	45.9	54.7	71.3	62.9	64.2	60.6	57.1	58.3
0.125	40	34.9	68	31.4	65.2	27.9	62.4	40.4	68.9	36.3	66.1	32.3	63.2	52	71	46.8	67.9	41.6	64.8
0.25	40	27.1	74	24.4	70.6	21.7	67.2	31.5	74.4	28.4	71	25.2	67.5	41.2	75.5	37.1	72	32.9	68.4
0.375	40	22.4	77.5	20.1	73.8	17.9	70	26	77.8	23.4	74	20.8	70.2	34.3	78.4	30.9	74.5	27.4	70.7
0.5	40	19.2	79.9	17.3	75.9	15.3	72	22.3	80	20.1	76	17.9	72	29.5	80.3	26.6	76.3	23.6	72.3
0.625	40	16.9	81.6	15.2	77.4	13.5	73.3	19.7	81.6	17.7	77.4	15.7	73.3	26	81.8	23.4	77.6	20.8	73.4
0.75	40	15.2	82.8	13.7	78.5	12.1	74.3	17.6	82.8	15.9	78.5	14.1	74.2	23.4	82.8	21	78.6	18.7	74.3
1	40	12.8	84.5	11.5	80	10.2	75.6	14.8	84.4	13.3	80	11.8	75.5	19.5	84.4	17.6	79.9	15.6	75.5
1.25	40	11.1	85.6	10	81	8.9	76.5	12.8	85.5	11.6	80.9	10.3	76.4	16.9	85.4	15.2	80.9	13.5	76.3
1.5	40	9.9	86.4	9	81.7	8	77.1	11.4	86.3	10.3	81.6	9.2	77	15	86.1	13.5	81.5	12	76.9
2	40	8.4	87.3	7.5	82.6	6.7	77.9	9.6	87.2	8.6	82.5	7.6	77.8	12.4	87.1	11.2	82.4	9.9	77.7
2.5	40	7.3	88	6.6	83.2	5.9	78.4	8.3	87.9	7.5	83.1	6.7	78.3	10.7	87.7	9.6	83	8.6	78.2
0	45	45.2	59.5	40.2	57.9	35.2	56.3	51.7	61.5	45.9	59.7	40.2	57.8	64.2	65.6	57.1	63.3	49.9	61.1
0.125	45	31.4	70.2	27.9	67.4	24.4	64.6	36.3	71.1	32.3	68.2	28.3	65.2	46.8	72.9	41.6	69.8	36.4	66.7
0.25	45	24.4	75.6	21.7	72.2	19	68.8	28.4	76	25.2	72.5	22.1	69.1	37.1	77	32.9	73.4	28.8	69.9
0.375	45	20.1	78.8	17.9	75	15.7	71.3	23.4	79	20.8	75.2	18.2	71.4	30.9	79.5	27.4	75.7	24	71.9
0.5	45	17.3	80.9	15.3	77	13.4	73	20.1	81	17.9	77	15.6	73	26.6	81.3	23.6	77.3	20.7	73.2
0.625	45	15.2	82.4	13.5	78.3	11.8	74.1	17.7	82.4	15.7	78.3	13.8	74.1	23.4	82.6	20.8	78.4	18.2	74.2
0.75	45	13.7	83.5	12.1	79.3	10.6	75	15.9	83.5	14.1	79.2	12.4	74.9	21	83.6	18.7	79.3	16.3	75
1	45	11.5	85	10.2	80.6	8.9	76.2	13.3	85	11.8	80.5	10.3	76.1	17.6	84.9	15.6	80.5	13.7	76.1
1.25	45	10	86	8.9	81.5	7.8	76.9	11.6	85.9	10.3	81.4	9	76.9	15.2	85.9	13.5	81.3	11.8	76.8
1.5	45	9	86.7	8	82.1	7	77.4	10.3	86.6	9.2	82	8	77.4	13.5	86.5	12	81.9	10.5	77.3
2	45	7.5	87.6	6.7	82.9	5.8	78.2	8.6	87.5	7.6	82.8	6.7	78.1	11.2	87.4	9.9	82.7	8.7	78
2.5	45	6.6	88.2	5.9	83.4	5.1	78.6	7.5	88.1	6.7	83.3	5.8	78.5	9.6	88	8.6	83.2	7.5	78.4
0	50	40.2	62.9	35.2	61.3	30.1	59.7	45.9	64.7	40.2	62.8	34.4	61	57.1	68.3	49.9	66.1	42.8	63.8
0.125	50	27.9	72.4	24.4	69.6	20.9	66.8	32.3	73.2	28.3	70.2	24.2	67.4	41.6	74.8	36.4	71.7	31.2	68.6
0.25	50	21.7	77.2	19	73.8	16.3	70.4	25.2	77.5	22.1	74.1	18.9	70.7	32.9	78.4	28.8	74.9	24.7	71.3
0.375	so	17.9	80	15.7	76.3	13.4	72.5	20.8	80.2	18.2	76.4	15.6	72.7	27.4	80.7	24	76.9	20.6	73
0.5	50	15.3	82	13.4	78	11.5	74	17.9	82	15.6	78	13.4	74	23.6	82.3	20.7	78.2	17.7	74.2
0.625	50	13.5	83.3	11.8	79.1	10.1	75	15.7	83.3	13.8	79.1	11.8	75	20.8	83.4	18.2	79.2	15.6	75.1
0.75	50	12.1	84.3	10.6	80	9.1	75.7	14.1	84.2	12.4	79.9	10.6	75.7	18.7	84.3	16.3	80	14	75.7
1	50	10.2	85.6	8.9	81.2	7.7	76.7	11.8	85.5	10.3	81.1	8.9	76.6	15.6	85.5	13.7	81.1	11.7	76.6
1.25	50	8.9	86.5	7.8	81.9	6.7	77.4	10.3	86.4	9.8	81.9	7.7	77.3	13.5	86.3	11.8	81.8	10.1	77.3
1.5	50	8	87.1	7	82.4	6	77.8	9.2	87	8.2	82.4	6.9	77.8	12	86.9	10.5	82.3	9	77.7
2	50	6.7	87.9	5.8	83.2	5	78.4	7.6	87.8	6.7	83.1	5.7	78.4	9.9	87.7	8.7	83	7.4	78.3
2.5	50	5.9	88.4	5.1	83.6	4.4	78.8	6.7	88.3	5.8	83.5	5	78.7	8.6	88.2	7.5	83.4	6.4	78.6
0	55	35.2	66.3	30.1	64.7	25.1	63.1	40.2	67.8	34.4	66	28.7	64.2	49.9	71.1	42.8	68.8	35.7	66.5
0.125	55	24.4	74.6	20.9	71.8	17.4	69	28.3	75.2	24.2	72.4	20.2	69.5	36.4	76.7	31.2	73.6	26	70.5
0.25	55	19	78.8	16.3	75.4	13.5	72	22.1	79.1	18.9	75.7	15.8	72.2	28.8	79.9	24.7	76.3	20.6	72.8
0.375	55	15.7	81.3	13.4	77.5	11.2	73.8	18.2	81.4	15.6	77.7	13	73.9	24	81.9	20.6	78	17.2	74.2
0.5	55	13.4	83	11.5	79	9.6	75	15.6	83	13.4	79	11.2	75	20.7	83.2	17.7	79.2	14.8	75.2
0.625	55	11.8	84.1	10.1	80	8.5	75.8	13.8	84.1	11.8	80	9.8	75.8	18.2	84.2	15.6	80.1	13	75.9
0.75	55	10.6	85	9.1	80.7	7.6	76.4	12.4	84.9	10.6	80.7	8.8	76.4	16.3	85	14	80.7	11.7	76.4
1	55	8.9	86.2	7.7	81.7	6.4	77.2	10.3	86.1	8.9	81.6	7.4	77.2	13.7	86.1	11.7	81.6	9.8	77.2
1.25	55	7.8	86.9	6.7	82.4	5.6	77.8	9	86.9	7.7	82.3	6.4	77.8	11.8	86.8	10.1	82.3	8.4	77.7
1.5	55	7	87.4	6	82.8	5	78.2	8	87.4	6.9	82.8	5.7	78.1	10.5	87.3	9	82.7	7.5	78.1
2	55	5.8	88.2	5	83.4	4.2	78.7	6.7	88.1	5.7	83.4	4.8	78.6	8.7	88	7.4	83.3	6.2	78.6
2.5	55	5.1	88.6	4.4	83.8	3.7	79	5.8	88.5	5.1	83.7	4.2	78.9	7.5	88.4	6.4	83.6	5.4	78.9

Fluid Temp = temperature of the chilled water (F).
Heat Gain (Btu per linear foot of pipe) calculated from Equation C-67.



Table App A-43. Heat Gain Values for Pro150 in Still Air Conditions (continued)

Nominal Insulation Thickness (inches)	Fluid Temp (F)	Pipe Size = 8", O.D. = 7.87"						Pipe Size = 10", O.D. = 9.84"						Pipe Size = 12", O.D. = 12.4"					
		Ambient Temperature (F)						Ambient Temperature (F)						Ambient Temperature (F)					
		90		85		80		90		85		80		90		85		80	
		Heat Gain	Surface Temp	Heat Gain	Surface Temp	Heat Gain	Surface Temp	Heat Gain	Surface Temp	Heat Gain	Surface Temp	Heat Gain	Surface Temp	Heat Gain	Surface Temp	Heat Gain	Surface Temp	Heat Gain	Surface Temp
0	35	88.2	63.2	80.2	60.7	72.2	58.1	97.6	66.3	88.8	63.5	79.9	60.6	107.3	69.3	97.5	66.2	87.8	63.1
0.125	35	65.8	70.7	59.9	67.4	53.9	64.2	74.8	72.3	68	68.9	61.2	65.5	84.6	74	76.9	70.5	69.2	66.9
0.25	35	52.8	74.9	48	71.3	43.2	67.7	61	75.9	55.4	72.2	49.9	68.5	70.1	77	63.7	73.2	57.3	69.4
0.375	35	44.3	77.7	40.3	73.8	36.3	69.9	51.6	78.4	46.9	74.4	42.2	70.5	60	79.1	54.5	75.1	49.1	71.1
0.5	35	38.3	79.7	34.8	75.6	31.4	71.5	44.9	80.1	40.8	76	36.7	71.9	52.5	80.6	47.8	76.5	43	72.3
0.625	35	33.9	81.1	30.8	76.9	27.7	72.7	39.8	81.4	36.2	77.2	32.6	73	46.8	81.8	42.6	77.5	38.3	73.3
0.75	35	30.4	82.3	27.6	78	24.9	73.7	35.8	82.5	32.6	78.1	29.3	73.8	42.3	82.7	38.5	78.4	34.6	74.1
1	35	25.4	83.9	23.1	79.4	20.8	75	30	84	27.3	79.5	24.6	75	35.6	84.1	32.4	79.6	29.1	75.2
1.25	35	22	84.9	20	80.4	18	75.9	26	85	23.6	80.4	21.3	75.9	30.9	85	28.1	80.5	25.3	75.9
1.5	35	19.5	85.7	17.7	81.1	15.9	76.5	23	85.7	20.9	81.1	18.8	76.5	27.4	85.8	24.9	81.1	22.4	76.5
2	35	16	86.8	14.6	82.1	13.1	77.4	18.9	86.7	17.2	82	15.5	77.3	22.5	86.7	20.5	82	18.4	77.3
2.5	35	13.8	87.4	12.5	82.7	11.3	77.9	16.2	87.4	14.8	82.6	13.3	77.9	19.3	87.4	17.5	82.6	15.8	77.8
0	40	80.2	65.7	72.2	63.1	64.2	60.5	88.8	68.5	79.9	65.6	71	62.8	97.5	71.2	87.8	68.1	78	65
0.125	40	59.9	72.4	53.9	69.2	47.9	65.9	68	73.9	61.2	70.5	54.4	67.1	76.9	75.5	69.2	71.9	61.5	68.4
0.25	40	48	76.3	43.2	72.7	38.4	69	55.4	77.2	49.9	73.5	44.3	69.8	63.7	78.2	57.3	74.4	51	70.6
0.375	40	40.3	78.8	36.3	74.9	32.2	71.1	46.9	79.4	42.2	75.5	37.5	71.5	54.5	80.1	49.1	76.1	43.6	72.1
0.5	40	34.8	80.6	31.4	76.5	27.9	72.5	40.8	81	36.7	76.9	32.6	72.8	47.8	81.5	43	77.3	38.2	73.2
0.625	40	30.8	81.9	27.7	77.7	24.6	73.6	36.2	82.2	32.6	78	28.9	73.8	42.6	82.5	38.3	78.3	34.1	74
0.75	40	27.6	83	24.9	78.7	22.1	74.4	32.6	83.1	29.3	78.8	26.1	74.5	38.5	83.4	34.6	79.1	30.8	74.7
1	40	23.1	84.4	20.8	80	18.5	75.5	27.3	84.5	24.6	80	21.8	75.6	32.4	84.6	29.1	80.2	25.9	75.7
1.25	40	20	85.4	18	80.9	16	76.3	23.6	85.4	21.3	80.9	18.9	76.3	28.1	85.5	25.3	80.9	22.5	76.4
1.5	40	17.7	86.1	15.9	81.5	14.2	76.9	20.9	86.1	18.8	81.5	16.7	76.9	24.9	86.1	22.4	81.5	19.9	76.9
2	40	14.6	87.1	13.1	82.4	11.7	77.6	17.2	87	15.5	82.3	13.8	77.6	20.5	87	18.4	82.3	16.4	77.6
2.5	40	12.5	87.7	11.3	82.9	10	78.1	14.8	87.6	13.3	82.9	11.8	78.1	17.5	87.6	15.8	82.8	14	78.1
0	45	72.2	68.1	64.2	65.5	56.1	63	79.9	70.6	71	67.8	62.1	64.9	87.8	73.1	78	70	68.3	66.9
0.125	45	53.9	74.2	47.9	70.9	41.9	67.7	61.2	75.5	54.4	72.1	47.6	68.7	69.2	76.9	61.5	73.4	53.8	69.8
0.25	45	43.2	77.7	38.4	74	33.6	70.4	49.9	78.5	44.3	74.8	38.8	71	57.3	79.4	51	75.6	44.6	71.7
0.375	45	36.3	79.9	32.2	76.1	28.2	72.2	42.2	80.5	37.5	76.5	32.8	72.6	49.1	81.1	43.6	77.1	38.2	73.1
0.5	45	31.4	81.5	27.9	77.5	24.4	73.4	36.7	81.9	32.6	77.8	28.6	73.7	43	82.3	38.2	78.2	33.4	74
0.625	45	27.7	82.7	24.6	78.6	21.5	74.4	32.6	83	28.9	78.8	25.3	74.6	38.3	83.3	34.1	79	29.8	74.8
0.75	45	24.9	83.7	22.1	79.4	19.3	75.1	29.3	83.8	26.1	79.5	22.8	75.2	34.6	84.1	30.8	79.7	26.9	75.4
1	45	20.8	85	18.5	80.5	16.2	76.1	24.6	85	21.8	80.6	19.1	76.1	29.1	85.2	25.9	80.7	22.7	76.2
1.25	45	18	85.9	16	81.3	14	76.8	21.3	85.9	18.9	81.3	16.5	76.8	25.3	85.9	22.5	81.4	19.7	76.8
1.5	45	15.9	86.5	14.2	81.9	12.4	77.3	18.8	86.5	16.7	81.9	14.7	77.3	22.4	86.5	19.9	81.9	17.4	77.3
2	45	13.1	87.4	11.7	82.6	10.2	77.9	15.5	87.3	13.8	82.6	12	77.9	18.4	87.3	16.4	82.6	14.3	77.9
2.5	45	11.3	87.9	10	83.1	8.8	78.4	13.3	87.9	11.8	83.1	10.3	78.3	15.8	87.8	14	83.1	12.3	78.3
0	50	64.2	70.5	56.1	68	48.1	65.4	71	72.8	62.1	69.9	53.3	67.1	78	75	68.3	71.9	58.5	68.7
0.125	50	47.9	75.9	41.9	72.7	35.9	69.4	54.4	77.1	47.6	73.7	40.8	70.3	61.5	78.4	53.8	74.8	46.1	71.3
0.25	50	38.4	79	33.6	75.4	28.8	71.8	44.3	79.8	38.8	76	33.3	72.3	51	80.6	44.6	76.7	38.2	72.9
0.375	50	32.2	81.1	28.2	77.2	24.2	73.3	37.5	81.5	32.8	77.6	28.1	73.7	43.6	82.1	38.2	78.1	32.7	74.1
0.5	50	27.9	82.5	24.4	78.4	20.9	74.4	32.6	82.8	28.6	78.7	24.5	74.6	38.2	83.2	33.4	79	28.7	74.9
0.625	50	24.6	83.6	21.5	79.4	18.5	75.2	28.9	83.8	25.3	79.6	21.7	75.3	34.1	84	29.8	79.8	25.5	75.5
0.75	50	22.1	84.4	19.3	80.1	16.6	75.8	26.1	84.5	22.8	80.2	19.5	75.9	30.8	84.7	26.9	80.4	23.1	76
1	50	18.5	85.5	16.2	81.1	13.9	76.6	21.8	85.6	19.1	81.1	16.4	76.7	25.9	85.7	22.7	81.2	19.4	76.8
1.25	50	16	86.3	14	81.8	12	77.2	18.9	86.3	16.5	81.8	14.2	77.3	22.5	86.4	19.7	81.8	16.9	77.3
1.5	50	14.2	86.9	12.4	82.3	10.6	77.7	16.7	86.9	14.7	82.3	12.6	77.7	19.9	86.9	17.4	82.3	14.9	77.7
2	50	11.7	87.6	10.2	82.9	8.8	78.2	13.8	87.6	12	82.9	10.3	78.2	16.4	87.6	14.3	82.9	12.3	78.2
2.5	50	10	88.1	8.8	83.4	7.5	78.6	11.8	88.1	10.3	83.3	8.9	78.6	14	88.1	12.3	83.3	10.5	78.6
0	55	56.1	73	48.1	70.4	40.1	67.8	62.1	74.9	53.3	72.1	44.4	69.2	68.3	76.9	58.5	73.7	48.8	70.6
0.125	55	41.9	77.7	35.9	74.4	29.9	71.2	47.6	78.7	40.8	75.3	34	72	53.8	79.8	46.1	76.3	38.5	72.7
0.25	55	33.6	80.4	28.8	76.8	24	73.2	38.8	81	33.3	77.3	27.7	73.6	44.6	81.7	38.2	77.9	31.9	74.1
0.375	55	28.2	82.2	24.2	78.3	20.1	74.4	32.8	82.6	28.1	78.7	23.5	74.7	38.2	83.1	32.7	79.1	27.3	75
0.5	55	24.4	83.4	20.9	79.4	17.4	75.3	28.6	83.7	24.5	79.6	20.4	75.5	33.4	84	28.7	79.9	23.9	75.7
0.625	55	21.5	84.4	18.5	80.2	15.4	76	25.3	84.6	21.7	80.3	18.1	76.1	29.8	84.8	25.5	80.5	21.3	76.3
0.75	55	19.3	85.1	16.6	80.8	13.8	76.5	22.8	85.2	19.5	80.9	16.3	76.6	26.9	85.4	23.1	81	19.2	76.7
1	55	16.2	86.1	13.9	81.6	11.6	77.2	19.1	86.1	16.4	81.7	13.7	77.2	22.7	86.2	19.4	81.8	16.2	77.3
1.25	55	14	86.8	12	82.2	10	77.7	16.5	86.8	14.2	82.3	11.8	77.7	19.7	86.8	16.9	82.3	14	77.8
1.5	55	12.4	87.3	10.6	82.7	8.9	78	14.7	87.3	12.6	82.7	10.5	78	17.4	87.3	14.9	82.7	12.5	78.1
2	55	10.2	87.9	8.8	83.2	7.3	78.5	12	87.9	10.3	83.2	8.6	78.5	14.3	87.9	12.3	83.2	10.2	78.5
2.5	155	8.8	88.4	7.5	83.6	6.3	78.8	10.3	88.3	18.9	83.6	7.4	78.81	12.3	88.31	10.5	83.6	8.8	78.8

Fluid Temp = temperature of the chilled water (F).
Heat Gain (Btu per linear foot of pipe) calculated from Equation C-67.

Table App. A-43. Heat Gain Values for Pro 150 in Still Air Conditions (continued)

Nominal Insulation Thickness (inches)	Fluid Temp (F)	Pipe Size = 14", O.D. = 13.98"						Pipe Size = 16", O.D. = 15.75"						Pipe Size = 18", O.D. = 17.72"					
		Ambient Temperature (F)						Ambient Temperature (F)						Ambient Temperature (F)					
		90		85		80		90		85		80		90		85		80	
		Heat Gain	Surface Temp	Heat Gain	Surface Temp	Heat Gain	Surface Temp	Heat Gain	Surface Temp	Heat Gain	Surface Temp	Heat Gain	Surface Temp	Heat Gain	Surface Temp	Heat Gain	Surface Temp	Heat Gain	Surface Temp
0	35	112.1	70.9	101.9	67.6	91.8	64.3	116.7	72.3	106.1	68.9	95.5	65.5	120.9	73.7	109.9	70.2	98.9	66.7
0.125	35	89.7	75.0	81.6	71.3	73.4	67.7	94.8	75.9	86.2	72.1	77.5	68.4	99.6	76.8	90.6	73.0	81.5	69.2
0.25	35	75.0	77.6	68.2	73.8	61.4	69.9	80.0	78.2	72.7	74.3	65.4	70.4	84.9	78.9	77.2	74.9	69.5	70.9
0.375	35	64.6	79.5	58.7	75.5	52.9	71.4	69.3	80.0	63.0	75.9	56.7	71.8	80.4	67.3	76.3	60.6	60.6	72.2
0.5	35	56.8	80.9	51.7	76.8	46.5	72.6	61.3	81.3	55.7	77.1	50.1	72.9	65.8	81.6	59.8	77.4	53.8	73.1
0.625	35	50.8	82.0	46.2	77.8	41.6	73.5	55.0	82.3	50.0	78.0	45.0	73.7	59.3	82.5	53.9	78.2	48.5	73.9
0.75	35	46.0	82.9	41.8	78.6	37.7	74.2	49.9	83.1	46.4	78.7	40.9	74.3	54.0	83.3	49.1	78.9	44.2	74.5
1	35	38.9	84.2	35.3	79.7	31.8	75.2	42.3	84.3	38.5	79.8	34.6	75.3	45.9	84.4	41.8	79.9	37.6	75.4
1.25	35	33.8	85.1	30.7	80.6	27.6	76.0	36.8	85.2	33.5	80.6	30.1	76.1	40.1	85.3	36.5	80.7	32.8	76.1
1.5	35	30.0	85.8	27.2	81.2	24.5	76.6	32.7	85.8	29.8	81.2	26.8	76.6	35.7	85.9	32.4	81.3	29.2	76.6
2	35	24.6	86.7	22.4	82.0	20.2	77.3	26.9	86.7	24.5	82.0	22.0	77.3	29.4	86.8	26.7	82.1	24.1	77.4
2.5	35	21.1	87.3	19.2	82.6	17.3	77.8	23.1	87.3	21.0	82.6	18.9	77.8	25.2	87.4	22.9	82.6	20.6	77.8
0	40	101.9	72.6	91.8	69.3	81.6	66.1	106.1	73.9	95.5	70.5	84.9	67.1	109.9	75.2	99.9	71.7	88.0	68.1
0.125	40	81.6	76.3	73.4	72.7	65.3	69.0	86.2	77.1	77.5	73.4	68.9	69.7	90.6	78.0	81.5	74.2	72.5	70.4
0.25	40	66.2	78.8	61.4	74.9	54.6	71.0	72.7	79.3	65.4	75.4	58.2	71.4	77.2	79.9	69.5	75.9	61.7	71.9
0.375	40	58.7	80.5	52.9	76.4	47.0	72.4	63.0	80.9	56.7	76.8	50.4	72.7	67.3	81.3	60.6	77.2	53.9	73.0
0.5	40	51.7	81.8	46.5	77.6	41.3	73.4	55.7	82.1	50.1	77.9	44.6	73.6	59.8	82.4	53.8	78.1	47.9	73.9
0.625	40	46.2	82.8	41.6	78.5	37.0	74.2	50.0	83.0	45.0	78.7	40.0	74.4	53.9	83.2	48.5	78.9	43.1	74.6
0.75	40	41.8	83.6	37.7	79.2	33.5	74.8	45.4	83.7	40.9	79.3	36.3	75.0	49.1	83.9	44.2	79.5	39.3	75.1
1	40	35.3	84.7	31.8	80.2	28.3	75.8	38.5	84.8	34.6	80.3	30.8	75.9	41.8	84.9	37.6	80.4	33.4	76.0
1.25	40	30.7	85.6	27.6	81.0	24.6	76.4	33.5	85.6	30.1	81.1	26.8	76.5	36.5	85.7	32.8	81.1	29.2	76.6
1.5	40	27.2	86.2	24.5	81.6	21.8	76.9	29.8	86.2	26.8	81.6	23.8	77.0	32.4	86.3	29.2	81.6	25.9	77.0
2	40	22.4	87.0	20.2	82.3	17.9	77.6	24.5	87.0	22	82.3	19.6	77.6	26.7	87.1	24.1	82.4	21.4	77.6
2.5	40	19.2	87.6	17.3	82.8	15.3	78.1	21.0	87.6	18.9	82.8	16.8	78.1	22.9	87.6	20.6	82.8	18.3	78.1
0	45	91.8	74.3	81.6	71.1	71.4	67.8	95.5	75.5	84.9	72.1	74.3	68.7	98.9	76.7	88.0	73.1	77.0	69.6
0.125	45	73.4	77.7	65.3	74.0	57.1	70.4	77.5	78.4	68.9	74.7	60.3	71.0	81.5	79.2	72.5	75.4	63.4	71.6
0.25	45	61.4	79.9	54.6	76.0	47.7	72.1	65.4	80.4	58.2	76.4	50.9	72.5	69.5	80.9	61.7	76.9	54.0	72.9
0.375	45	52.9	81.4	47.0	77.4	41.1	73.3	56.7	81.8	50.4	77.7	44.1	73.6	60.6	82.2	53.9	78.0	47.1	73.9
0.5	45	46.5	82.6	41.3	78.4	36.2	74.2	50.1	82.9	44.6	78.6	39.0	74.4	53.8	83.1	47.9	78.9	41.9	74.7
0.625	45	41.6	83.5	37.0	79.2	32.3	74.9	45.0	83.7	40.0	79.4	35.0	75.1	48.5	83.9	43.1	79.6	37.7	75.3
0.75	45	37.7	84.2	33.5	79.8	29.3	75.5	40.9	84.3	36.3	80.0	31.8	75.6	44.2	84.5	39.3	80.1	34.3	75.7
1	45	31.8	85.2	28.3	80.8	24.7	76.3	34.6	85.3	30.8	80.9	26.9	76.4	37.6	85.4	33.4	81.0	29.2	76.5
1.25	45	27.6	86.0	24.6	81.4	21.5	76.9	30.1	86.1	26.8	81.5	23.4	76.9	32.8	86.1	29.2	81.6	25.5	77.0
1.5	45	24.5	86.6	21.8	81.9	19.1	77.3	26.8	86.6	23.8	82	20.8	77.4	29.2	86.6	25.9	82.0	22.7	77.4
2	45	20.2	87.3	17.9	82.6	15.7	77.9	22.0	87.3	19.6	82.6	17.1	77.9	24.1	87.4	21.4	82.6	18.7	77.9
2.5	45	17.3	87.8	15.3	83.1	13.4	78.3	18.9	87.8	16.8	83.1	14.7	78.3	20.6	87.8	18.3	83.1	16.0	78.3
0	50	81.6	76.1	71.4	72.8	61.2	69.5	84.9	77.1	74.3	73.7	63.7	70.3	88.0	78.1	77.0	74.6	66.0	71.1
0.125	50	65.3	79.0	57.1	75.4	49.0	71.8	68.9	79.7	60.3	76.0	51.7	72.3	72.5	80.4	63.4	76.6	54.3	72.8
0.25	50	54.6	81.0	47.7	77.1	40.9	73.3	58.2	81.4	50.9	77.5	43.6	73.6	61.7	81.9	54.0	77.9	46.3	73.9
0.375	50	47.0	82.4	41.1	78.3	35.2	74.3	50.4	82.7	44.1	78.6	37.8	74.5	53.9	83.0	47.1	78.9	40.4	74.8
0.5	50	41.3	83.4	36.2	79.2	31.0	75.1	44.6	83.6	39.0	79.4	33.4	75.2	47.9	83.9	41.9	79.7	35.9	75.4
0.625	50	37.0	84.2	32.3	79.9	27.7	75.7	40.0	84.4	35.0	80.1	30.0	75.8	43.1	84.6	37.7	80.3	32.3	75.9
0.75	50	33.5	84.8	29.3	80.5	25.1	76.1	36.3	85.0	31.8	80.6	27.2	76.2	39.3	85.1	34.3	80.7	29.4	76.3
1	50	28.3	85.8	24.7	81.3	21.2	76.8	30.8	85.9	26.9	81.4	23.1	76.9	33.4	86.0	29.2	81.5	25.1	77.0
1.25	50	24.6	86.4	21.5	81.9	18.4	77.3	26.8	86.5	23.4	81.9	20.1	77.4	29.2	86.6	25.5	82.0	21.9	77.4
1.5	50	21.8	86.9	19.1	82.3	16.3	77.7	23.8	87.0	20.8	82.4	17.9	77.7	25.9	87.0	22.7	82.4	19.5	77.8
2	50	17.9	87.6	15.7	82.9	13.4	78.2	19.6	87.6	17.1	82.9	14.7	78.2	21.4	87.6	18.7	82.9	16.0	78.2
2.5	50	15.3	88.1	13.4	83.3	11.5	78.6	16.8	88.1	14.7	83.3	12.6	78.6	18.3	88.1	16.0	83.3	13.7	78.6
0	55	71.4	77.8	61.2	74.5	51.0	71.3	74.3	78.7	63.7	75.3	53.1	72.0	77.0	79.6	66.0	76.1	55.0	72.6
0.125	55	57.1	80.4	49.0	76.8	40.8	73.2	60.3	81	51.7	77.3	43.1	73.6	63.4	81.6	54.3	77.8	45.3	74.0
0.25	55	47.7	82.1	40.9	78.3	34.1	74.4	50.9	82.5	43.6	78.6	36.4	74.7	54.0	82.9	46.3	78.9	38.6	74.9
0.375	55	41.1	83.3	35.2	79.3	29.4	75.2	44.1	83.6	37.8	79.5	31.5	75.4	47.1	83.9	40.4	79.8	33.7	75.6
0.5	55	36.2	84.2	31.0	80.1	25.8	75.9	39.0	84.4	33.4	80.2	27.9	76.0	41.9	84.7	35.9	80.4	29.9	76.2
0.625	55	32.3	84.9	27.7	80.7	23.1	76.4	35.0	85.1	30.0	80.8	25.0	76.5	37.7	85.3	32.3	80.9	26.9	76.6
0.75	55	29.3	85.5	25.1	81.1	20.9	76.8	31.8	85.6	27.2	81.2	22.7	76.9	34.3	85.7	29.4	81.3	24.5	77.0
1	55	24.7	86.3	21.2	81.8	17.7	77.4	26.9	86.4	23.1	81.9	19.2	77.4	29.2	86.5	25.1	82.0	20.9	77.5
1.25	55	21.5	86.9	18.4	82.3	15.4	77.8	23.4	86.9	20.1	82.4	16.7	77.8	25.5	87.0	21.9	82.4	18.2	77.9
1.5	55	19.1	87.3	16.3	82.7	13.6	78.1	20.8	87.4	17.9	82.7	14.9	78.1	22.7	87.4	19.5	82.8	16.2	78.1
2	55	15.7	87.9	13.4	83.2	11.2	78.5	17.1	87.9	14.7	83.2	12.2	78.5	18.7	87.9	16.0	83.2	13.4	78.5
2.5	155	13.4	88.3	11.5	83.6	9.6	78.8	14.7	88.3	12.6	83.6	10.5	78.8	16.1	88.3	13.7	83.6	11.5	78.8

Fluid Temp = temperature of the chilled water (F).
Heat Gain (Btu per linear foot of pipe) calculated from Equation C-67.

Table App. A-44. Heat Gain Values for Pro 150 in Moving Air Conditions

Nominal Insulation Thickness (inches)	Fluid Temp (F)	Pipe Size = 0.5", O.D. = 0.79"						Pipe Size = 0.75", O.D. = 0.98"						Pipe Size = 1", O.D. = 1.26"					
		Ambient Temperature (F)						Ambient Temperature (F)						Ambient Temperature (F)					
		90		85		80		90		85		80		90		85		80	
		Heat Gain	Surface Temp	Heat Gain	Surface Temp	Heat Gain	Surface Temp	Heat Gain	Surface Temp	Heat Gain	Surface Temp	Heat Gain	Surface Temp	Heat Gain	Surface Temp	Heat Gain	Surface Temp	Heat Gain	Surface Temp
0	35	43.7	54.8	39.7	53	35.7	51.2	53.0	55.6	48.2	53.7	43.4	51.8	65.8	56.8	59.9	54.7	53.9	52.8
0.125	35	18.3	78.8	16.6	74.8	14.9	70.9	21.9	78.7	19.9	74.7	17.9	70.7	27.1	78.6	24.6	74.6	22.1	70.7
0.25	35	12.5	83.8	11.3	79.4	10.2	75.0	14.7	83.7	13.4	79.2	12.1	74.8	18.0	83.5	16.4	79.1	14.7	74.7
0.375	35	9.8	85.9	8.9	81.3	8.1	76.7	11.5	85.8	10.5	81.1	9.4	76.5	13.9	85.6	12.7	81.0	11.4	76.4
0.5	35	8.3	87.0	7.6	82.3	6.8	77.6	9.7	86.9	8.8	82.2	7.9	77.5	11.6	86.7	10.5	82.0	9.5	77.3
0.625	35	7.4	87.7	6.7	82.9	6.0	78.1	8.5	87.6	7.7	82.8	6.9	78.0	10.1	87.4	9.2	82.7	8.2	77.9
0.75	35	6.7	88.1	6.1	83.3	5.4	78.5	7.6	88.0	6.9	83.2	6.2	78.4	9.0	87.9	8.2	83.1	7.4	78.3
1	35	5.7	88.7	5.2	83.8	4.7	78.9	6.5	88.6	5.9	83.7	5.3	78.9	7.6	88.5	6.9	83.7	6.2	78.8
1.25	35	5.1	89.0	4.7	84.1	4.2	79.2	5.8	88.9	5.2	84.0	4.7	79.1	6.7	88.9	6.1	84.0	5.5	79.1
1.5	35	4.7	89.2	4.3	84.3	3.8	79.4	5.3	89.2	4.8	84.2	4.3	79.3	6.0	89.1	5.5	84.2	4.9	79.3
2	35	4.1	89.5	3.7	84.5	3.4	79.5	4.6	89.4	4.2	84.5	3.7	79.5	5.2	89.4	4.7	84.4	4.3	79.5
2.5	35	3.8	89.6	3.4	84.6	3.1	79.7	4.1	89.6	3.8	84.6	3.4	79.6	4.7	89.5	4.2	84.6	3.8	79.6
0	40	39.7	58.0	35.7	56.2	31.8	54.4	48.2	58.7	43.4	56.8	38.6	54.9	59.9	59.7	53.9	57.8	47.9	55.8
0.125	40	16.6	79.8	14.9	75.9	13.3	71.9	19.9	79.7	17.9	75.7	15.9	71.8	24.6	79.6	22.1	75.7	19.7	71.7
0.25	40	11.3	84.4	10.2	80.0	9.1	75.5	13.4	84.2	12.1	79.8	10.7	75.4	16.4	84.1	14.7	79.7	13.1	75.3
0.375	40	8.9	86.3	8.1	81.7	7.2	77.0	10.5	86.1	9.4	81.5	8.4	76.9	12.7	86.0	11.4	81.4	10.1	76.8
0.5	40	7.6	87.3	6.8	82.6	6.1	77.8	8.8	87.2	7.9	82.5	7.0	77.7	10.5	87.0	9.5	82.3	8.4	77.6
0.625	40	6.7	87.9	6.0	83.1	5.4	78.3	7.7	87.8	6.9	83.0	6.2	78.2	9.2	87.7	8.2	82.9	7.3	78.1
0.75	40	6.1	88.3	5.4	83.5	4.8	78.7	6.9	88.2	6.2	83.4	5.5	78.6	8.2	88.1	7.4	83.3	6.5	78.5
1	40	5.2	88.8	4.7	83.9	4.2	79.0	5.9	88.7	5.3	83.9	4.7	79.0	6.9	88.7	6.2	83.8	5.5	78.9
1.25	40	4.7	89.1	4.2	84.2	3.7	79.3	5.2	89.0	4.7	84.1	4.2	79.2	6.1	89.0	5.5	84.1	4.9	79.2
1.5	40	4.3	89.3	3.8	84.4	3.4	79.4	4.8	89.2	4.3	84.3	3.8	79.4	5.5	89.2	4.9	84.3	4.4	79.3
2	40	3.7	89.5	3.4	84.5	3.0	79.6	4.2	89.5	3.7	84.5	3.3	79.6	4.7	89.4	4.3	84.5	3.8	79.5
2.5	40	3.4	89.6	3.1	84.7	2.7	79.7	3.8	89.6	3.4	84.6	3.0	79.7	4.2	89.6	3.8	84.6	3.4	79.7
0	45	35.7	61.2	31.8	59.4	27.8	57.6	43.4	61.8	38.6	59.9	33.7	58.1	53.9	62.8	47.9	60.8	41.9	58.8
0.125	45	14.9	80.9	13.3	76.9	11.6	72.9	17.9	80.7	15.9	76.8	13.9	72.8	22.1	80.7	19.7	76.7	17.2	72.7
0.25	45	10.2	85.0	9.1	80.5	7.9	76.1	12.1	84.8	10.7	80.4	9.4	76.0	14.7	84.7	13.1	80.3	11.5	75.8
0.375	45	8.1	86.7	7.2	82.0	6.3	77.4	9.4	86.5	8.4	81.9	7.3	77.3	11.4	86.4	10.1	81.8	8.9	77.2
0.5	45	6.8	87.6	6.1	82.8	5.3	78.1	7.9	87.5	7.0	82.7	6.2	78.0	9.5	87.3	8.4	82.6	7.4	77.9
0.625	45	6.0	88.1	5.4	83.3	4.7	78.5	6.9	88.0	6.2	83.2	5.4	78.5	8.2	87.9	7.3	83.1	6.4	78.4
0.75	45	5.4	88.5	4.8	83.7	4.2	78.8	6.2	88.4	5.5	83.6	4.9	78.7	7.4	88.3	6.5	83.5	5.7	78.7
1	45	4.7	88.9	4.2	84.0	3.6	79.2	5.3	88.9	4.7	84	4.1	79.1	6.2	88.8	5.5	83.9	4.8	79.1
1.25	45	4.2	89.2	3.7	84.3	3.3	79.4	4.7	89.1	4.2	84.2	3.7	79.3	5.5	89.1	4.9	84.2	4.3	79.3
1.5	45	3.8	89.4	3.4	84.4	3.0	79.5	4.3	89.3	3.8	84.4	3.3	79.5	4.9	89.3	4.4	84.3	3.8	79.4
2	45	3.4	89.5	3.0	84.6	2.6	79.7	3.7	89.5	3.3	84.6	2.9	79.6	4.3	89.5	3.8	84.5	3.3	79.6
2.5	45	3.1	89.7	2.7	84.7	2.4	79.7	3.4	89.6	3.0	84.7	2.6	79.7	3.8	89.6	3.4	84.7	3.0	79.7
0	50	31.8	64.4	27.8	62.6	23.8	60.8	38.6	64.9	33.7	63.1	28.9	61.2	47.9	65.8	41.9	63.8	35.9	61.9
0.125	50	13.3	81.9	11.6	77.9	10.0	73.9	15.9	81.8	13.9	77.8	11.9	73.8	19.7	81.7	17.2	77.7	14.8	73.8
0.25	50	9.1	85.5	7.9	81.1	6.8	76.6	10.7	85.4	9.4	81.0	8.0	76.6	13.1	85.3	11.5	80.8	9.8	76.5
0.375	50	7.2	87.0	6.3	82.4	5.4	77.8	8.4	86.9	7.3	82.3	6.3	77.7	10.1	86.8	8.9	82.2	7.6	77.6
0.5	50	6.1	87.8	5.3	83.1	4.5	78.4	7.0	87.7	6.2	83.0	5.3	78.3	8.4	87.6	7.4	82.9	6.3	78.2
0.625	50	5.4	88.3	4.7	83.5	4.0	78.8	6.2	88.2	5.4	83.5	4.6	78.7	7.3	88.1	6.4	83.4	5.5	78.6
0.75	50	4.8	88.7	4.2	83.8	3.6	79.0	5.5	88.6	4.9	83.7	4.2	78.9	6.5	88.5	5.7	83.7	4.9	78.9
1	50	4.2	89.0	3.6	84.2	3.1	79.3	4.7	89.0	4.1	84.1	3.5	79.3	5.5	88.9	4.8	84.1	4.1	79.2
1.25	50	3.7	89.3	3.3	84.4	2.8	79.5	4.2	89.2	3.7	84.3	3.1	79.4	4.9	89.2	4.3	84.3	3.6	79.4
1.5	50	3.4	89.4	3.0	84.5	2.6	79.6	3.8	89.4	3.3	84.5	2.9	79.5	4.4	89.3	3.8	84.4	3.3	79.5
2	50	3.0	89.6	2.6	84.7	2.2	79.7	3.3	89.6	2.9	84.6	2.5	79.7	3.8	89.5	3.3	84.6	2.8	79.7
2.5	50	2.7	89.7	2.4	84.7	2.0	79.8	3.0	89.7	2.6	84.7	2.3	79.8	3.4	89.7	3.0	84.7	2.5	79.7
0	55	27.8	67.6	23.8	65.8	19.8	64.0	33.7	68.1	28.9	66.2	24.1	64.3	41.9	66.8	35.9	66.9	29.9	64.9
0.125	55	11.6	82.9	10.0	78.9	8.3	74.9	13.9	82.8	11.9	78.8	9.9	74.9	17.2	82.7	14.8	78.8	12.3	74.8
0.25	55	7.9	86.1	6.8	81.6	5.7	77.2	9.4	86.0	8.0	81.6	6.7	77.1	11.5	85.8	9.8	81.5	8.2	77.0
0.375	55	6.3	87.4	5.4	82.8	4.5	78.1	7.3	87.3	6.3	82.7	5.2	78.1	8.9	87.2	7.6	82.6	6.3	78.0
0.5	55	5.3	88.1	4.5	83.4	3.8	78.6	6.2	88.0	5.3	83.3	4.4	78.6	7.4	87.9	6.3	83.2	5.3	78.5
0.625	55	4.7	88.5	4.0	83.8	3.3	79.0	5.4	88.5	4.6	83.7	3.9	78.9	6.4	88.4	5.5	83.6	4.6	78.8
0.75	55	4.2	88.8	3.6	84.0	3.0	79.2	4.9	88.7	4.2	83.9	3.5	79.1	5.7	88.7	4.9	83.9	4.1	79.1
1	55	3.6	89.2	3.1	84.3	2.6	79.4	4.1	89.1	3.5	84.3	3.0	79.4	4.8	89.1	4.1	84.2	3.4	79.3
1.25	55	3.3	89.4	2.8	84.5	2.3	79.6	3.7	89.3	3.1	84.4	2.6	79.5	4.3	89.3	3.6	84.4	3.0	79.5
1.5	55	3.0	89.5	2.6	84.6	2.1	79.6	3.3	89.5	2.9	84.5	2.4	79.6	3.8	89.4	3.3	84.5	2.7	79.6
2	55	2.6	89.7	2.2	84.7	1.9	79.7	2.9	89.6	2.5	84.7	2.1	79.7	3.3	89.6	2.8	84.7	2.4	79.7
2.5	55	2.4	89.7	2.0	84.8	1.7	79.8	2.6	89.7	2.3	84.8	1.9	79.8	3.0	89.7	2.5	84.7	2.1	79.8

Fluid Temp = temperature of the chilled water (F).
Heat Gain (Btu per linear foot of pipe) calculated from Equation C-67.

Table App. A-44. Heat Gain Values for Pro 150 in Moving Air Conditions (continued)

Nominal Insulation Thickness (inches)	Fluid Temp (F)	Pipe Size = 1.25", O.D. = 1.58"						Pipe Size = 1.5", O.D. = 1.97"						Pipe Size = 2", O.D. = 2.48"					
		Ambient Temperature (F)						Ambient Temperature (F)						Ambient Temperature (F)					
		90		85		80		90		85		80		90		85		80	
		Heat Gain	Surface Temp	Heat Gain	Surface Temp	Heat Gain	Surface Temp	Heat Gain	Surface Temp	Heat Gain	Surface Temp	Heat Gain	Surface Temp	Heat Gain	Surface Temp	Heat Gain	Surface Temp	Heat Gain	Surface Temp
0	35	76.6	59.1	69.6	57.0	62.6	54.8	85.1	62.5	77.4	60.0	69.6	57.5	94.8	65.7	86.2	62.9	77.6	60.1
0.125	35	32.3	78.8	29.4	74.8	26.4	70.8	37.8	79.2	34.4	75.1	30.9	71.1	44.5	79.6	40.5	75.6	36.4	71.5
0.25	35	21.4	83.5	19.5	79.0	17.5	74.6	25.2	83.5	22.9	79.1	20.6	74.7	30.0	83.6	27.2	79.2	24.5	74.8
0.375	35	16.5	85.5	15.0	80.9	13.5	76.3	19.4	85.5	17.6	80.9	15.8	76.3	23.0	85.5	20.9	80.9	18.8	76.3
0.5	35	13.6	86.6	12.4	81.9	11.2	77.2	16.0	86.6	14.5	81.9	13.1	77.2	18.9	86.5	17.2	81.9	15.5	77.2
0.625	35	11.8	87.3	10.7	82.6	9.7	77.8	13.8	87.3	12.5	82.5	11.3	77.8	16.3	87.2	14.8	82.5	13.3	77.7
0.75	35	10.5	87.8	9.5	83.0	8.6	78.2	12.2	87.8	11.1	83.0	10.0	78.2	14.4	87.7	13.1	82.9	11.8	78.1
1	35	8.8	88.4	8.0	83.6	7.2	78.7	10.1	88.4	9.2	83.5	8.3	78.7	11.8	88.3	10.8	83.5	9.7	78.6
1.25	35	7.7	88.8	7.0	83.9	6.3	79.0	8.8	88.7	8.0	83.9	7.2	79.0	10.2	88.7	9.3	83.8	8.4	78.9
1.5	35	6.9	89.0	6.3	84.1	5.6	79.2	7.9	89.0	7.1	84.1	6.4	79.2	9.1	88.9	8.3	84.0	7.4	79.1
2	35	5.9	89.3	5.3	84.4	4.8	79.5	6.6	89.3	6.0	84.4	5.4	79.4	7.6	89.3	6.9	84.3	6.2	79.4
2.5	35	5.2	89.5	4.8	84.5	4.3	79.6	5.9	89.5	5.3	84.5	4.8	79.6	6.7	89.4	6.1	84.5	5.5	79.5
0	40	69.6	62.0	62.6	59.8	55.7	57.6	77.4	65.0	69.6	62.5	61.9	60.0	86.2	67.9	77.6	65.1	69.0	62.3
0.125	40	29.4	79.8	26.4	75.8	23.5	71.8	34.4	80.1	30.9	76.1	27.5	72.1	40.5	80.6	36.4	76.5	32.4	72.4
0.25	40	19.5	84.0	17.5	79.6	15.6	75.2	22.9	84.1	20.6	79.7	18.3	75.3	27.2	84.2	24.5	79.8	21.8	75.3
0.375	40	15.0	85.9	13.5	81.3	12.0	76.7	17.6	85.9	15.8	81.3	14.1	76.7	20.9	85.9	18.8	81.3	16.7	76.7
0.5	40	12.4	86.9	11.2	82.2	9.9	77.6	14.5	86.9	13.1	82.2	11.6	77.5	17.2	86.9	15.5	82.2	13.8	77.5
0.625	40	10.7	87.6	9.7	82.8	8.6	78.1	12.5	87.5	11.3	82.8	10.0	78.0	14.8	87.5	13.3	82.7	11.8	78.0
0.75	40	9.5	88.0	8.6	83.2	7.6	78.4	11.1	88.0	10.0	83.2	8.9	78.4	13.1	87.9	11.8	83.1	10.4	78.3
1	40	8.0	88.6	7.2	83.7	6.4	78.9	9.2	88.5	8.3	83.7	7.4	78.8	10.8	88.5	9.7	83.6	8.6	78.8
1.25	40	7.0	88.9	6.3	84.0	5.6	79.1	8.0	88.9	7.2	84.0	6.4	79.1	9.3	88.8	8.4	83.9	7.4	79.1
1.5	40	6.3	89.1	5.6	84.2	5.0	79.3	7.1	89.1	6.4	84.2	5.7	79.3	8.3	89.0	7.4	84.1	6.6	79.2
2	40	5.3	89.4	4.8	84.5	4.3	79.5	6.0	89.4	5.4	84.4	4.8	79.5	6.9	89.3	6.2	84.4	5.5	79.5
2.5	40	4.8	89.5	4.3	84.6	3.8	79.6	5.3	89.5	4.8	84.6	4.3	79.6	6.1	89.5	5.5	84.5	4.9	79.6
0	45	62.6	64.8	55.7	62.6	48.7	60.4	69.6	67.5	61.9	65.0	54.2	62.5	77.6	70.1	69.0	67.3	60.3	64.5
0.125	45	26.4	80.8	23.5	76.8	20.6	72.8	30.9	81.1	27.5	77.1	24.1	73.1	36.4	81.5	32.4	77.4	28.3	73.4
0.25	45	17.5	84.6	15.6	80.2	13.6	75.8	20.6	84.7	18.3	80.3	16.0	75.9	24.5	84.8	21.8	80.3	19.1	75.9
0.375	45	13.5	86.3	12.0	81.7	10.5	77.1	15.8	86.3	14.1	81.7	12.3	77.1	18.8	86.3	16.7	81.7	14.6	77.1
0.5	45	11.2	87.2	9.9	82.6	8.7	77.9	13.1	87.2	11.6	82.5	10.2	77.8	15.5	87.2	13.8	82.5	12.1	77.8
0.625	45	9.7	87.8	8.6	83.1	7.5	78.3	11.3	87.8	10.0	83.0	8.8	78.3	13.3	87.7	11.8	83.0	10.4	78.2
0.75	45	8.6	88.2	7.6	83.4	6.7	78.6	10.0	88.2	8.9	83.4	7.8	78.6	11.8	88.1	10.4	83.3	9.1	78.5
1	45	7.2	88.7	6.4	83.9	5.6	79.0	8.3	88.7	7.4	83.8	6.4	79.0	9.7	88.6	8.6	83.8	7.5	78.9
1.25	45	6.3	89.0	5.6	84.1	4.9	79.2	7.2	89.0	6.4	84.1	5.6	79.2	8.4	88.9	7.4	84.1	6.5	79.2
1.5	45	5.6	89.2	5.0	84.3	4.4	79.4	6.4	89.2	5.7	84.3	5.0	79.4	7.4	89.1	6.6	84.2	5.8	79.3
2	45	4.8	89.5	4.3	84.5	3.7	79.6	5.4	89.4	4.8	84.5	4.2	79.6	6.2	89.4	5.5	84.5	4.9	79.5
2.5	45	4.3	89.6	3.8	84.6	3.3	79.7	4.8	89.6	4.3	84.6	3.7	79.7	5.5	89.5	4.9	84.6	4.3	79.6
0	50	55.7	67.6	48.7	65.4	41.8	63.2	61.9	70.0	54.2	67.5	46.4	65.0	69.0	72.3	60.3	69.5	51.7	66.7
0.125	50	23.5	81.8	20.6	77.8	17.6	73.9	27.5	82.1	24.1	78.1	20.6	74.1	32.4	82.4	28.3	78.4	24.3	74.3
0.25	50	15.6	85.2	13.6	80.8	11.7	76.4	18.3	85.3	16.0	80.9	13.8	76.4	21.8	85.3	19.1	80.9	16.3	76.5
0.375	50	12.0	86.7	10.5	82.1	9.0	77.5	14.1	86.7	12.3	82.1	10.6	77.5	16.7	86.7	14.6	82.1	12.6	77.5
0.5	50	9.9	87.6	8.7	82.9	7.4	78.2	11.6	87.5	10.2	82.8	8.7	78.1	13.8	87.5	12.1	82.8	10.3	78.1
0.625	50	8.6	88.1	7.5	83.3	6.4	78.6	10.0	88.0	8.8	83.3	7.5	78.5	11.8	88.0	10.4	83.2	8.9	78.5
0.75	50	7.6	88.4	6.7	83.6	5.7	78.8	8.9	88.4	7.8	83.6	6.7	78.8	10.4	88.3	9.1	83.5	7.8	78.8
1	50	6.4	88.9	5.6	84.0	4.8	79.1	7.4	88.8	6.4	84.0	5.5	79.1	8.6	88.8	7.5	83.9	6.5	79.1
1.25	50	5.6	89.1	4.9	84.2	4.2	79.3	6.4	89.1	5.6	84.2	4.8	79.3	7.4	89.1	6.5	84.2	5.6	79.3
1.5	50	5.0	89.3	4.4	84.4	3.8	79.5	5.7	89.3	5.0	84.4	4.3	79.4	6.6	89.2	5.8	84.3	5.0	79.4
2	50	4.3	89.5	3.7	84.6	3.2	79.6	4.8	89.5	4.2	84.6	3.6	79.6	5.5	89.5	4.9	84.5	4.2	79.6
2.5	50	3.8	89.6	3.3	84.7	2.9	79.7	4.3	89.6	3.7	84.7	3.2	79.7	4.9	89.6	4.3	84.6	3.7	79.7
0	55	48.7	70.4	41.8	68.2	34.8	66.0	54.2	72.5	46.4	70.0	38.7	67.5	60.3	74.5	51.7	71.7	43.1	68.9
0.125	55	20.6	82.8	17.6	78.9	14.7	74.9	24.1	83.1	20.6	79.1	17.2	75.1	28.3	83.4	24.3	79.3	20.2	75.3
0.25	55	13.6	85.8	11.7	81.4	9.7	77.0	16.0	85.9	13.8	81.4	11.5	77.0	19.1	85.9	16.3	81.5	13.6	77.1
0.375	55	10.5	87.1	9.0	82.5	7.5	78.0	12.3	87.1	10.6	82.5	8.8	77.9	14.6	87.1	12.6	82.5	10.5	77.9
0.5	55	8.7	87.9	7.4	83.2	6.2	78.5	10.2	87.8	8.7	83.1	7.3	78.4	12.1	87.8	10.3	83.1	8.6	78.4
0.625	55	7.5	88.3	6.4	83.6	5.4	78.8	8.8	88.3	7.5	83.5	6.3	78.8	10.4	88.2	8.9	83.5	7.4	78.7
0.75	55	6.7	88.6	5.7	83.8	4.8	79.0	7.8	88.6	6.7	83.8	5.5	79.0	9.1	88.5	7.8	83.8	6.5	79.0
1	55	5.6	89.0	4.8	84.1	4.0	79.3	6.4	89.0	5.5	84.1	4.6	79.3	7.5	88.9	6.5	84.1	5.4	79.2
1.25	55	4.9	89.2	4.2	84.3	3.5	79.5	5.6	89.2	4.8	84.3	4.0	79.4	6.5	89.2	5.6	84.3	4.6	79.4
1.5	55	4.4	89.4	3.8	84.5	3.1	79.6	5.0	89.4	4.3	84.4	3.6	79.5	5.8	89.3	5.0	84.4	4.1	79.5
2	55	3.7	89.6	3.2	84.6	2.7	79.7	4.2	89.6	3.6	84.6	3.0	79.7	4.9	89.5	4.2	84.6	3.5	79.7
2.5	55	3.3	89.7	2.9	84.7	2.4	79.8	3.7	89.7	3.2	84.7	2.7	79.8	4.3	89.6	3.7	84.7	3.0	79.7

Fluid Temp = temperature of the chilled water (F).
Heat Gain (Btu per linear foot of pipe) calculated from Equation C-67.

Table App. A-44. Heat Gain Values for Pro 150 in Moving Air Conditions (continued)

Nominal Insulation Thickness (inches)	Fluid Temp (F)	Pipe Size = 3", O.D. = 3.54"						Pipe Size = 4", O.D. = 4.33"						Pipe Size = 6", O.D. = 6.29"					
		Ambient Temperature (F)						Ambient Temperature (F)						Ambient Temperature (F)					
		90		85		80		90		85		80		90		85		80	
		Heat Gain	Surface Temp	Heat Gain	Surface Temp	Heat Gain	Surface Temp	Heat Gain	Surface Temp	Heat Gain	Surface Temp	Heat Gain	Surface Temp	Heat Gain	Surface Temp	Heat Gain	Surface Temp	Heat Gain	Surface Temp
0	35	109.9	70.2	99.9	67.0	89.9	63.8	117.8	72.7	107.1	69.3	96.4	65.8	130.2	76.8	118.3	73.0	106.5	69.2
0.125	35	56.6	80.5	51.5	76.3	46.3	72.2	64.3	81.1	58.4	76.9	52.6	72.7	79.2	82.3	72.0	78.0	64.8	73.7
0.25	35	38.9	83.9	35.4	79.4	31.9	75.0	44.9	84.1	40.8	79.6	36.7	75.2	57.5	84.6	52.3	80.1	47.1	75.6
0.375	35	30.1	85.5	27.3	80.9	24.6	76.3	34.9	85.6	31.7	81.0	28.6	76.4	45.5	85.9	41.4	81.3	37.2	76.6
0.5	35	24.8	86.5	22.5	81.8	20.3	77.2	28.8	86.6	26.2	81.9	23.6	77.2	37.9	86.7	34.4	82.0	31.0	77.3
0.625	35	21.2	87.2	19.3	82.4	17.4	77.7	24.7	87.2	22.4	82.4	20.2	77.7	32.6	87.2	29.6	82.5	26.7	77.7
0.75	35	18.7	87.6	17.0	82.9	15.3	78.1	21.7	87.6	19.7	82.8	17.8	78.1	28.7	87.7	26.1	82.9	23.5	78.1
1	35	15.3	88.2	13.9	83.4	12.5	78.6	17.7	88.2	16.1	83.4	14.5	78.5	23.4	88.2	21.3	83.4	19.1	78.5
1.25	35	13.1	88.6	11.9	83.7	10.7	78.9	15.1	88.6	13.7	83.7	12.4	78.8	19.9	88.6	18.1	83.7	16.3	78.8
1.5	35	11.6	88.9	10.5	84.0	9.5	79.1	13.3	88.8	12.1	83.9	10.9	79.1	17.5	88.8	15.9	83.9	14.3	79.0
2	35	9.6	89.2	8.7	84.3	7.8	79.3	10.9	89.2	10.0	84.2	9.0	79.3	14.2	89.1	12.9	84.2	11.6	79.3
2.5	35	8.3	89.4	7.5	84.4	6.8	79.5	9.5	89.4	8.6	84.4	7.7	79.5	12.2	89.3	11.1	84.4	10.0	79.4
0	40	99.9	72.0	89.9	68.8	79.9	65.6	107.1	74.3	96.4	70.8	85.7	67.4	118.3	78.0	106.5	74.2	94.7	70.4
0.125	40	51.5	81.3	46.3	77.2	41.2	73.1	58.4	81.9	52.6	77.7	46.7	73.5	72.0	83.0	64.8	78.7	57.6	74.4
0.25	40	35.4	84.4	31.9	80.0	28.3	75.5	40.8	84.6	36.7	80.2	32.7	75.7	52.3	85.1	47.1	80.6	41.8	76.1
0.375	40	27.3	85.9	24.6	81.3	21.9	76.8	31.7	86.0	28.6	81.4	25.4	76.8	41.4	86.3	37.2	81.6	33.1	77.0
0.5	40	22.5	86.8	20.3	82.2	18.0	77.5	26.2	86.9	23.6	82.2	21.0	77.5	34.4	87.0	31.0	82.3	27.5	77.6
0.625	40	19.3	87.4	17.4	82.7	15.4	78.0	22.4	87.4	20.2	82.7	18.0	77.9	29.6	87.5	26.7	82.7	23.7	78.0
0.75	40	17.0	87.9	15.3	83.1	13.6	78.3	19.7	87.8	17.8	83.1	15.8	78.3	26.1	87.9	23.5	83.1	20.9	78.3
1	40	13.9	88.4	12.5	83.6	11.1	78.7	16.1	88.4	14.5	83.5	12.9	78.7	21.3	88.4	19.1	83.5	17.0	78.7
1.25	40	11.9	88.7	10.7	83.9	9.5	79.0	13.7	88.7	12.4	83.8	11.0	79.0	18.1	88.7	16.3	83.8	14.5	78.9
1.5	40	10.5	89.0	9.5	84.1	8.4	79.2	12.1	88.9	10.9	84.1	9.7	79.2	15.9	88.9	14.3	84.0	12.7	79.1
2	40	8.7	89.3	7.8	84.3	7.0	79.4	10.0	89.2	9.0	84.3	8.0	79.4	12.9	89.2	11.6	84.3	10.3	79.4
2.5	40	7.5	89.4	6.8	84.5	6.0	79.6	8.6	89.4	7.7	84.5	6.9	79.5	11.1	89.4	10.0	84.4	8.9	79.5
0	45	89.9	73.8	79.9	70.6	69.9	67.4	96.4	75.8	85.7	72.4	75.0	69.0	106.5	79.2	94.7	75.4	82.8	71.6
0.125	45	46.3	82.2	41.2	78.1	36.0	74.0	52.6	82.7	46.7	78.5	40.9	74.3	64.8	83.7	57.6	79.4	50.4	75.1
0.25	45	31.9	85.0	28.3	80.5	24.8	76.1	36.7	85.2	32.7	80.7	28.6	76.2	47.1	85.6	41.8	81.1	36.6	76.6
0.375	45	24.6	86.3	21.9	81.8	19.1	77.2	28.6	86.4	25.4	81.8	22.2	77.2	37.2	86.6	33.1	82.0	29.0	77.4
0.5	45	20.3	87.2	18.0	82.5	15.8	77.8	23.6	87.2	21.0	82.5	18.3	77.8	31.0	87.3	27.5	82.6	24.1	77.9
0.625	45	17.4	87.7	15.4	83.0	13.5	78.2	20.2	87.7	18.0	82.9	15.7	78.2	26.7	87.7	23.7	83.0	20.7	78.3
0.75	45	15.3	88.1	13.6	83.3	11.9	78.5	17.8	88.1	15.8	83.3	13.8	78.5	23.5	88.1	20.9	83.3	18.3	78.5
1	45	12.5	88.6	11.1	83.7	9.7	78.9	14.5	88.5	12.9	83.7	11.3	78.9	19.1	88.5	17.0	83.7	14.9	78.9
1.25	45	10.7	88.9	9.5	84.0	8.3	79.1	12.4	88.8	11.0	84.0	9.6	79.1	16.3	88.8	14.5	83.9	12.7	79.1
1.5	45	9.5	89.1	8.4	84.2	7.4	79.3	10.9	89.1	9.7	84.2	8.5	79.3	14.3	89.0	12.7	84.1	11.1	79.2
2	45	7.8	89.3	7.0	84.4	6.1	79.5	9.0	89.3	8.0	84.4	7.0	79.5	11.6	89.3	10.3	84.4	9.1	79.4
2.5	45	6.8	89.5	6.0	84.6	5.3	79.6	7.7	89.5	6.9	84.5	6.0	79.6	10.0	89.4	8.9	84.5	7.8	79.6
0	50	79.9	75.6	69.9	72.4	59.9	69.2	85.7	77.4	75.0	74.6	4.3	70.5	94.7	80.4	82.8	76.6	71.0	72.8
0.125	50	41.2	83.1	36.0	79.0	30.9	74.8	46.7	83.5	40.9	79.3	35.1	75.1	57.6	84.4	50.4	80.1	43.2	75.8
0.25	50	28.3	85.5	24.8	81.1	21.2	76.7	32.7	85.7	28.6	81.2	24.5	76.8	41.8	86.1	36.6	81.6	31.4	77.1
0.375	50	21.9	86.8	19.1	82.2	16.4	77.6	25.4	86.8	22.2	82.2	19.0	77.6	33.1	87.0	29.0	82.4	24.8	77.8
0.5	50	18.0	87.5	15.8	82.8	13.5	78.1	21.0	87.5	18.3	82.8	15.7	78.1	27.5	87.6	24.1	82.9	20.7	78.2
0.625	50	15.4	88.0	13.5	83.2	11.6	78.5	18.0	87.9	15.7	83.2	13.5	78.5	23.7	88.0	20.7	83.3	17.8	78.5
0.75	50	13.6	88.3	11.9	83.5	10.2	78.7	15.8	88.3	13.8	83.5	11.8	78.7	20.9	88.3	18.3	83.5	15.7	78.7
1	50	11.1	88.7	9.7	83.9	8.3	79.0	12.9	88.7	11.3	83.9	9.7	79.0	17.0	88.7	14.9	83.9	12.8	79.0
1.25	50	9.5	89.0	8.3	84.1	7.1	79.3	11.0	89.0	9.6	84.1	8.2	79.2	14.5	88.9	12.7	84.1	10.9	79.2
1.5	50	8.4	89.2	7.4	84.3	6.3	79.4	9.7	89.2	8.5	84.3	7.3	79.4	12.7	89.1	11.1	84.2	9.5	79.3
2	50	7.0	89.4	6.1	84.5	5.2	79.6	8.0	89.4	7.0	84.5	6.0	79.5	10.3	89.4	9.1	84.4	7.8	79.5
2.5	50	6.0	89.6	5.3	84.6	4.5	79.7	6.9	89.5	6.0	84.6	5.2	79.6	8.9	89.5	7.8	84.6	6.6	79.6
0	55	69.9	77.4	59.9	74.2	49.9	71.0	75.0	79.0	64.3	75.5	53.6	72.1	82.8	81.6	71.0	77.8	59.2	74.0
0.125	55	36.0	84.0	30.9	79.8	25.7	75.7	40.9	84.3	35.1	80.1	29.2	75.9	50.4	85.1	43.2	80.8	36.0	76.5
0.25	55	24.8	86.1	21.2	81.7	17.7	7.2	28.6	86.2	24.5	81.8	20.4	77.3	36.6	86.6	31.4	82.1	26.1	77.6
0.375	55	19.1	87.2	16.4	82.6	13.7	78.0	22.2	87.2	19.0	82.6	15.9	78.0	29.0	87.4	24.8	82.8	20.7	78.1
0.5	55	15.8	87.8	13.5	83.1	11.3	78.4	18.3	87.8	15.7	83.1	13.1	78.4	24.1	87.9	20.7	83.2	17.2	78.5
0.625	55	13.5	88.2	11.6	83.5	9.6	78.7	15.7	88.2	13.5	83.5	11.2	78.7	20.7	88.3	17.8	83.5	14.8	78.8
0.75	55	11.9	88.5	10.2	83.7	8.5	78.9	13.8	88.5	11.8	83.7	9.9	78.9	18.3	88.5	15.7	83.7	13.0	78.9
1	55	9.7	88.9	8.3	84.0	6.9	79.2	11.3	88.9	9.7	84.0	8.0	79.2	14.9	88.9	12.8	84.0	10.6	79.2
1.25	55	8.3	89.1	7.1	84.3	5.9	79.4	9.6	89.1	8.2	84.2	6.9	79.4	12.7	89.1	10.9	84.2	9.1	79.3
1.5	55	7.4	89.3	6.3	84.4	5.3	79.5	8.5	89.3	7.3	84.4	6.1	79.5	11.1	89.2	9.5	84.3	7.9	79.5
2	55	6.1	89.5	5.2	84.6	4.3	79.6	7.0	89.5	6.0	84.5	5.0	79.6	9.1	89.4	7.8	84.5	6.5	79.6
2.5	55	5.3	89.6	4.5	84.7	3.8	79.7	6.0	89.6	5.2	84.6	4.3	79.7	7.8	89.6	6.6	84.6	5.5	79.7

Fluid Temp = temperature of the chilled water (F).
Heat Gain (Btu per linear foot of pipe) calculated from Equation C-67.

Table App. A-44. Heat Gain Values for Pro 150 in Moving Air Conditions (continued)

Nominal Insulation Thickness (inches)	Fluid Temp (F)	Pipe Size = 8", O.D. = 7.87"						Pipe Size = 10", O.D. = 9.84"						Pipe Size = 12", O.D. = 12.4"					
		Ambient Temperature (F)						Ambient Temperature (F)						Ambient Temperature (F)					
		90		85		80		90		85		80		90		85		80	
		Heat Gain	Surface Temp	Heat Gain	Surface Temp	Heat Gain	Surface Temp	Heat Gain	Surface Temp	Heat Gain	Surface Temp	Heat Gain	Surface Temp	Heat Gain	Surface Temp	Heat Gain	Surface Temp	Heat Gain	Surface Temp
0	35	137.1	78.9	124.7	74.9	112.2	70.9	142.7	80.8	129.7	76.6	116.7	72.4	148.0	82.4	134.6	78.1	121.1	73.8
0.125	35	88.7	83.0	80.7	78.7	72.6	74.3	98.0	83.8	89.1	79.4	80.2	74.9	107.5	84.6	97.7	80.1	87.9	75.6
0.25	35	66.1	85.0	60.1	80.4	54.1	75.9	75.0	85.4	68.2	80.8	61.4	76.2	84.7	85.8	77.0	81.2	69.3	76.6
0.375	35	53.0	86.1	48.2	81.4	43.4	76.8	61.1	86.3	55.5	81.7	50.0	77.0	70.1	86.6	63.8	81.9	57.4	77.2
0.5	35	44.4	86.8	40.4	82.1	36.3	77.4	51.7	87.0	47.0	82.2	42.3	77.5	60.0	87.1	54.6	82.4	49.1	77.7
0.625	35	38.4	87.3	34.9	82.6	31.4	77.8	44.9	87.4	40.8	82.7	36.8	77.9	52.6	87.5	47.8	82.8	43.0	78.0
0.75	35	33.9	87.7	30.8	82.9	27.7	78.1	39.8	87.8	36.2	83.0	32.6	78.2	46.9	87.9	42.6	83.0	38.3	78.2
1	35	27.7	88.2	25.2	83.4	22.7	78.5	32.7	88.2	29.7	83.4	26.7	78.6	38.7	88.3	35.2	83.4	31.6	78.6
1.25	35	23.6	88.6	21.4	83.7	19.3	78.8	27.9	88.6	25.3	83.7	22.8	78.8	33.1	88.6	30.1	83.7	27.1	78.8
1.5	35	20.7	88.8	18.8	83.9	16.9	79.0	24.4	88.8	22.2	83.9	20.0	79.0	29.0	88.8	26.4	83.9	23.8	79
2	35	16.8	89.1	15.2	84.2	13.7	79.3	19.8	89.1	18.0	84.2	16.2	79.3	23.5	89.1	21.4	84.2	19.3	79.3
2.5	35	14.3	89.3	13.0	84.4	11.7	79.4	16.8	89.3	15.3	84.3	13.8	79.4	20.0	89.3	18.2	84.3	16.3	79.4
0	40	124.7	79.9	112.2	75.9	99.7	71.9	129.7	81.6	116.7	77.4	103.8	73.3	134.6	83.1	121.1	78.8	107.7	74.5
0.125	40	80.7	83.7	72.6	79.3	64.5	74.9	89.1	84.4	80.2	79.9	71.3	75.5	97.7	85.1	87.9	80.6	78.2	76.1
0.25	40	60.1	85.4	54.1	80.9	48.1	76.3	68.2	85.8	61.4	81.2	54.6	76.6	77.0	86.2	69.3	81.6	61.6	77.0
0.375	40	48.2	86.4	43.4	81.8	38.5	77.2	55.5	86.7	50.0	82.0	44.4	77.3	63.8	86.9	57.4	82.2	51.0	77.5
0.5	40	40.4	87.1	36.3	82.4	32.3	77.7	47.0	87.2	42.3	82.5	37.6	77.8	54.6	87.4	49.1	82.7	43.7	77.9
0.625	40	34.9	87.6	31.4	82.8	27.9	78.1	40.8	87.7	36.8	82.9	32.7	78.1	47.8	87.8	43.0	83.0	38.2	78.2
0.75	40	30.8	87.9	27.7	83.1	24.7	78.3	36.2	88.0	32.6	83.2	29.0	78.4	42.6	88.0	38.3	83.2	34.1	78.4
1	40	25.2	88.4	22.7	83.5	20.1	78.7	29.7	88.4	26.7	83.6	23.8	78.7	35.2	88.4	31.6	83.6	28.1	78.8
1.25	40	21.4	88.7	19.3	83.8	17.1	79.0	25.3	88.7	22.8	83.8	20.3	79.0	30.1	88.7	27.1	83.8	24.1	79.0
1.5	40	18.8	88.9	16.9	84.0	15.0	79.1	22.2	88.9	20.0	84.0	17.8	79.1	26.4	88.9	23.8	84.0	21.1	79.1
2	40	15.2	89.2	13.7	84.3	12.2	79.3	18.0	89.2	16.2	84.3	14.4	79.3	21.4	89.2	19.3	84.3	17.1	79.3
2.5	40	13.0	89.4	11.7	84.4	10.4	79.5	15.3	89.3	13.8	84.4	12.2	79.5	18.2	89.3	16.3	84.4	14.5	79.5
0	45	112.2	80.9	99.7	76.9	87.3	72.9	116.7	82.4	103.8	78.3	90.8	74.1	121.1	83.8	107.7	79.5	94.2	75.2
0.125	45	72.6	84.3	64.5	79.9	56.5	75.6	80.2	84.9	71.3	80.5	62.4	76.1	87.9	85.6	78.2	81.1	68.4	76.6
0.25	45	54.1	85.9	48.1	81.3	42.1	76.8	61.4	86.2	54.6	81.6	47.8	77.1	69.3	86.6	61.6	82.0	53.9	77.3
0.375	45	43.4	86.8	38.5	82.2	33.7	77.5	50.0	87.0	44.4	82.3	38.9	77.7	57.4	87.2	51.0	82.5	44.6	77.8
0.5	45	36.3	87.4	32.3	82.7	28.3	78.0	42.3	87.5	37.6	82.8	32.9	78.1	49.1	87.7	43.7	82.9	38.2	78.2
0.625	45	31.4	87.8	27.9	83.1	24.4	78.3	36.8	87.9	32.7	83.1	28.6	78.4	43.0	88.0	38.2	83.2	33.5	78.4
0.75	45	27.7	88.1	24.7	83.3	21.6	78.5	32.6	88.2	29.0	83.4	25.4	78.6	38.3	88.2	34.1	83.4	29.8	78.6
1	45	22.7	88.5	20.1	83.7	17.6	78.9	26.7	88.6	23.8	83.7	20.8	78.9	31.6	88.6	28.1	83.8	24.6	78.9
1.25	45	19.3	88.8	17.1	84.0	15.0	79.1	22.8	88.8	20.3	84.0	17.7	79.1	27.1	88.8	24.1	84.0	21.1	79.1
1.5	45	16.9	89.0	15.0	84.1	13.1	79.2	20.0	89.0	17.8	84.1	15.5	79.2	23.8	89.0	21.1	84.1	18.5	79.2
2	45	13.7	89.3	12.2	84.3	10.7	79.4	16.2	89.3	14.4	84.3	12.6	79.4	19.3	89.3	17.1	84.3	15.0	79.4
2.5	45	11.7	89.4	10.4	84.5	9.1	79.5	13.8	89.4	12.2	84.5	10.7	79.5	16.3	89.4	14.5	84.5	12.7	79.5
0	50	99.7	81.9	87.3	77.9	74.8	73.9	103.8	83.3	90.8	79.1	77.8	75.0	107.7	84.5	94.2	80.2	80.7	75.9
0.125	50	64.5	84.9	56.5	80.6	48.4	76.2	71.3	85.6	62.4	81.1	53.4	76.6	78.2	86.1	68.4	81.6	58.6	77.1
0.25	50	48.1	86.3	42.1	81.8	36.1	77.3	54.6	86.6	47.8	82.1	40.9	77.5	61.6	87.0	53.9	82.3	46.2	77.7
0.375	50	38.5	87.2	33.7	82.5	28.9	77.9	44.4	87.3	38.9	82.7	33.3	78.0	51.0	87.5	44.6	82.8	38.3	78.1
0.5	50	32.3	87.7	28.3	83.0	24.2	78.3	37.6	87.8	32.9	83.1	28.2	78.3	43.7	87.9	38.2	83.2	32.7	78.4
0.625	50	27.9	88.1	24.4	83.3	20.9	78.5	32.7	88.1	28.6	83.4	24.5	78.6	38.2	88.2	33.5	83.4	28.7	78.7
0.75	50	24.7	88.3	21.6	83.5	18.5	78.7	29.0	88.4	25.4	83.6	21.7	78.8	34.1	88.4	29.8	83.6	25.6	78.8
1	50	20.1	88.7	17.6	83.9	15.1	79.0	23.8	88.7	20.8	83.9	17.8	79.0	28.1	88.8	24.6	83.9	21.1	79.1
1.25	50	17.1	89.0	15.0	84.1	12.9	79.2	20.3	89.0	17.7	84.1	15.2	79.2	24.1	89.0	21.1	84.1	18.0	79.2
1.5	50	15.0	89.1	13.1	84.2	11.3	79.3	17.8	89.1	15.5	84.2	13.3	79.3	21.1	89.1	18.5	84.2	15.8	79.3
2	50	12.2	89.3	10.7	84.4	9.1	79.5	14.4	89.3	12.6	84.4	10.8	79.5	17.1	89.3	15.0	84.4	12.8	79.5
2.5	50	10.4	89.5	9.1	84.5	7.8	79.6	12.2	89.5	10.7	84.5	9.2	79.6	14.5	89.5	12.7	84.5	10.9	79.6
0	55	87.3	82.9	74.8	78.9	62.3	75.0	90.8	84.1	77.8	80.0	64.9	75.8	94.2	85.2	80.7	80.9	67.3	76.5
0.125	55	56.5	85.6	48.4	81.2	40.3	76.8	62.4	86.1	53.4	81.6	44.5	77.2	68.4	86.6	58.6	82.1	48.9	77.5
0.25	55	42.1	86.8	36.1	82.3	30.1	77.7	47.8	87.1	40.9	82.5	34.1	77.9	53.9	87.3	46.2	82.7	38.5	78.1
0.375	55	33.7	87.5	28.9	82.9	24.1	78.2	38.9	87.7	33.3	83.0	27.8	78.3	44.6	87.8	38.3	83.1	31.9	78.5
0.5	55	28.3	88.0	24.2	83.3	20.2	78.6	32.9	88.1	28.2	83.3	23.5	78.6	38.2	88.2	32.7	83.4	27.3	78.7
0.625	55	24.4	88.3	20.9	83.5	17.4	78.8	28.6	88.4	24.5	83.6	20.4	78.8	33.5	88.4	28.7	83.7	23.9	78.9
0.75	55	21.6	88.5	18.5	83.7	15.4	79.0	25.4	88.6	21.7	83.8	18.1	79.0	29.8	88.6	25.6	83.8	21.3	79.0
1	55	17.6	88.9	15.1	84.0	12.6	79.2	20.8	88.9	17.8	84.0	14.9	79.2	24.6	88.9	21.1	84.1	17.6	79.2
1.25	55	15.0	89.1	12.9	84.2	10.7	79.3	17.7	89.1	15.2	84.2	12.7	79.3	21.1	89.1	18.0	84.2	15.0	79.4
1.5	55	13.1	89.2	11.3	84.3	9.4	79.4	15.5	89.2	13.3	84.3	11.1	79.4	18.5	89.2	15.8	84.3	13.2	79.5
2	55	10.7	89.4	9.1	84.5	7.6	79.6	12.6	89.4	10.8	84.5	9.0	79.6	15.0	89.4	12.8	84.5	10.7	79.6
2.5	55	9.1	89.5	7.8	84.6	6.5	79.7	10.7	89.5	9.2	84.6	7.6	79.7	12.7	89.5	10.9	84.6	9.1	79.7

Fluid Temp = temperature of the chilled water (F).
Heat Gain (Btu per linear foot of pipe) calculated from Equation C-67.

Table App. A-44. Heat Gain Values for Pro 150 in Moving Air Conditions (continued)

Nominal Insulation Thickness (inches)	Fluid Temp (F)	Pipe Size = 14", O.D. = 13.98"						Pipe Size = 16", O.D. = 15.75"						Pipe Size = 18", O.D. = 17.72"					
		Ambient Temperature (F)						Ambient Temperature (F)						Ambient Temperature (F)					
		90		85		80		90		85		80		90		85		80	
		Heat Gain	Surface Temp	Heat Gain	Surface Temp	Heat Gain	Surface Temp	Heat Gain	Surface Temp	Heat Gain	Surface Temp	Heat Gain	Surface Temp	Heat Gain	Surface Temp	Heat Gain	Surface Temp	Heat Gain	Surface Temp
0	35	150.6	83.1	136.9	78.8	123.2	74.4	152.7	83.8	138.9	79.4	125.0	74.9	154.5	84.4	140.5	80.0	126.4	75.5
0.125	35	112.3	85.0	102.1	80.4	91.9	75.9	116.8	85.4	106.2	80.8	95.6	76.2	121.0	85.7	110.0	81.1	99.0	76.5
0.25	35	89.8	86.1	81.7	81.4	73.5	76.8	94.8	86.3	86.2	81.6	77.6	77.0	99.7	86.5	90.6	81.8	81.5	77.2
0.375	35	75.1	86.8	68.3	82.0	61.4	77.3	80.0	86.9	72.7	82.2	65.5	77.5	84.9	87.1	77.2	82.3	69.5	77.6
0.5	35	64.6	87.3	58.8	82.5	52.9	77.8	69.3	87.4	63.0	82.6	56.7	77.8	74.1	87.5	67.3	82.7	60.6	77.9
0.625	35	56.0	87.6	51.7	82.8	46.5	78.1	61.3	87.7	55.7	82.9	50.1	78.1	65.8	87.8	59.8	83.0	53.8	78.2
0.75	35	50.8	87.9	46.2	83.1	41.6	78.3	55.0	88.0	50.0	83.2	45.0	78.3	59.3	88.0	53.9	83.2	48.5	78.4
1	35	42.1	88.3	38.3	83.5	34.5	78.6	45.8	88.4	41.6	83.5	37.5	78.7	49.6	88.4	45.1	83.5	40.6	78.7
1.25	35	36.1	88.6	32.9	83.7	29.6	78.9	39.4	88.6	35.8	83.8	32.2	78.9	42.8	88.7	38.9	83.8	35.0	78.9
1.5	35	31.7	88.8	28.9	83.9	26.0	79.0	34.7	88.8	31.5	83.9	28.4	79.0	37.7	88.8	34.3	83.9	30.9	79.1
2	35	25.8	89.1	23.4	84.2	21.1	79.3	28.2	89.1	25.6	84.2	23.0	79.3	30.7	89.1	27.9	84.2	25.2	79.3
2.5	35	21.9	89.3	19.9	84.3	17.9	79.4	23.9	89.3	21.7	84.3	19.6	79.4	26.1	89.3	23.7	84.3	21.4	79.4
0	40	136.9	83.8	123.2	79.4	109.5	75.0	138.9	84.4	125.0	79.9	111.1	75.5	140.5	85.0	126.4	80.5	112.4	76.0
0.125	40	102.1	85.4	91.9	80.9	81.7	76.3	106.2	85.8	95.6	81.2	85.0	76.6	110.0	86.1	99.0	81.5	88.0	76.9
0.25	40	81.7	86.4	73.5	81.8	65.3	77.1	86.2	86.6	77.6	82.0	69.0	77.3	90.6	86.8	81.5	82.2	72.5	77.5
0.375	40	68.3	87	61.4	82.3	54.6	77.6	72.7	87.2	65.5	82.5	58.2	77.8	77.2	87.3	69.5	82.6	61.8	77.9
0.5	40	58.8	87.5	52.9	82.8	47.0	78.0	63.0	87.6	56.7	82.8	50.4	78.1	67.3	87.7	60.6	82.9	53.9	78.2
0.625	40	51.7	87.8	46.5	83.1	41.4	78.3	55.7	87.9	50.1	83.1	44.6	78.3	59.8	88.0	53.8	83.2	47.9	78.4
0.75	40	46.2	88.1	41.6	83.3	37.0	78.5	50.0	88.2	45.0	83.3	40.0	78.5	53.9	88.2	48.5	83.4	43.1	78.6
1	40	38.3	88.5	34.5	83.6	30.6	78.8	41.6	88.5	37.5	83.7	33.3	78.8	45.1	88.5	40.6	83.7	36.1	78.8
1.25	40	32.9	88.7	29.6	83.9	26.3	79.0	35.8	88.8	32.2	83.9	28.6	79.0	38.9	88.8	35.0	83.9	31.1	79.0
1.5	40	28.9	88.9	26.0	84.0	23.1	79.1	31.5	88.9	28.4	84.0	25.2	79.1	34.3	88.9	30.9	84.1	27.5	79.2
2	40	23.4	89.2	21.1	84.3	18.7	79.3	25.6	89.2	23.0	84.3	20.5	79.3	27.9	89.2	25.2	84.3	22.4	79.3
2.5	40	19.9	89.3	17.9	84.4	15.9	79.5	21.7	89.3	19.6	84.4	17.4	79.5	23.7	89.3	21.4	84.4	19.0	79.5
0	45	123.2	84.4	109.5	80.0	95.8	75.6	125.0	84.9	111.1	80.5	97.2	76.1	126.4	85.5	112.4	81.0	98.3	76.5
0.125	45	91.9	85.9	81.7	81.3	71.5	76.8	95.6	86.2	85.0	81.6	74.3	77.0	99.0	86.5	88.0	81.9	77.0	77.3
0.25	45	73.5	86.8	65.3	82.1	57.2	77.5	77.6	87.0	69.0	82.3	60.4	77.6	81.5	87.2	72.5	82.5	63.4	77.8
0.375	45	61.4	87.3	54.6	82.6	47.8	77.9	65.5	87.5	58.2	82.8	50.9	78.0	69.5	87.6	61.8	82.9	54.0	78.1
0.5	45	52.9	87.8	47.0	83.0	41.1	78.3	56.7	87.8	50.4	83.1	44.1	78.3	60.6	87.9	53.9	83.2	47.1	78.4
0.625	45	46.5	88.1	41.4	83.3	36.2	78.5	50.1	88.1	44.6	83.3	39.0	78.5	53.8	88.2	47.9	83.4	41.9	78.6
0.75	45	41.6	88.3	37.0	83.5	32.4	78.7	45.0	88.3	40.0	83.5	35.0	78.7	48.5	88.4	43.1	83.6	37.7	78.8
1	45	34.5	88.6	30.6	83.8	26.8	78.9	37.5	88.7	33.3	83.8	29.1	79.0	40.6	88.7	36.1	83.8	31.6	79.0
1.25	45	29.6	88.9	26.3	84.0	23.0	79.1	32.2	88.9	28.6	84.0	25.1	79.1	35.0	88.9	31.1	84.0	27.2	79.1
1.5	45	26	89.0	23.1	84.1	20.2	79.2	28.4	89	25.2	84.1	22.1	79.2	30.9	89.1	27.5	84.2	24.0	79.3
2	45	21.1	89.3	18.7	84.3	16.4	79.4	23.0	89.3	20.5	84.3	17.9	79.4	25.2	89.3	22.4	84.3	19.6	79.4
2.5	45	17.9	89.4	15.9	84.5	13.9	79.5	19.6	89.4	17.4	84.5	15.2	79.5	21.4	89.4	19.0	84.5	16.6	79.5
0	50	109.5	85.0	95.8	80.6	82.1	76.3	111.1	85.5	97.2	81.1	83.3	76.6	112.4	86.0	98.3	81.5	84.3	77.0
0.125	50	81.7	86.3	71.5	81.8	61.3	77.3	85.0	86.6	74.3	82.0	63.7	77.5	88.0	86.9	77.0	82.3	66.0	77.7
0.25	50	65.3	87.1	57.2	82.5	49.0	77.8	69.0	87.3	60.4	82.6	51.7	78.0	72.5	87.5	63.4	82.8	54.4	78.1
0.375	50	54.6	87.6	47.8	82.9	41.0	78.2	58.2	87.8	50.9	83.0	43.6	78.3	61.8	87.9	54.0	83.1	46.3	78.4
0.5	50	47.0	88.0	41.1	83.3	35.3	78.5	50.4	88.1	44.1	83.3	37.8	78.6	53.9	88.2	47.1	83.4	40.4	78.6
0.625	50	41.4	88.3	36.2	83.5	31.0	78.7	44.6	88.3	39.0	83.5	33.4	78.7	47.9	88.4	41.9	83.6	35.9	78.8
0.75	50	37.0	88.5	32.4	83.7	27.7	78.9	40.0	88.5	35.0	83.7	30.0	78.9	43.1	88.6	37.7	83.8	32.3	78.9
1	50	30.6	88.8	26.8	83.9	23.0	79.1	33.3	88.8	29.1	84.0	25.0	79.1	36.1	88.8	31.6	84.0	27.1	79.1
1.25	50	26.3	89.0	23.0	84.1	19.7	79.2	28.6	89.0	25.1	84.1	21.5	79.3	31.1	89.0	27.2	84.1	23.3	79.3
1.5	50	23.1	89.1	20.2	84.2	17.3	79.4	25.2	89.1	22.1	84.2	18.9	79.4	27.5	89.2	24.0	84.3	20.6	79.4
2	50	18.7	89.3	16.4	84.4	14.1	79.5	20.5	89.3	17.9	84.4	15.4	79.5	22.4	89.3	19.6	84.4	16.8	79.5
2.5	50	15.9	89.5	13.9	84.5	11.9	79.6	17.4	89.5	15.2	84.5	13.0	79.6	19.0	89.5	16.6	84.5	14.2	79.6
0	55	95.8	85.6	82.1	81.3	68.5	76.9	97.2	86.1	83.3	81.6	69.4	77.2	98.3	86.5	84.3	82.0	70.2	77.5
0.125	55	71.5	86.8	61.3	82.3	51.0	77.7	74.3	87.0	63.7	82.5	53.1	77.9	77.0	87.3	66.0	82.7	55.0	78.1
0.25	55	57.2	87.5	49.0	82.8	40.8	78.2	60.4	87.6	51.7	83.0	43.1	78.3	63.4	87.8	54.4	83.1	45.3	78.4
0.375	55	47.8	87.9	41.0	83.2	34.1	78.5	50.9	88.0	43.6	83.3	36.4	78.6	54.0	88.1	46.3	83.4	38.6	78.7
0.5	55	41.1	88.3	35.3	83.5	29.4	78.8	44.1	88.3	37.8	83.6	31.5	78.8	47.1	88.4	40.4	83.6	33.7	78.9
0.625	55	36.2	88.5	31.0	83.7	25.8	78.9	39.0	88.5	33.4	83.7	27.9	79.0	41.9	88.6	35.9	83.8	29.9	79.0
0.75	55	32.4	88.7	27.7	83.9	23.1	79.1	35.0	88.7	30.0	83.9	25.0	79.1	37.7	88.8	32.3	83.9	26.9	79.1
1	55	26.8	88.9	23.0	84.1	19.2	79.2	29.1	89.0	25.0	84.1	20.8	79.3	31.6	89.0	27.1	84.1	22.5	79.3
1.25	55	23.0	89.1	19.7	84.2	16.4	79.4	25.1	89.1	21.5	84.3	17.9	79.4	27.2	89.1	23.3	84.3	19.5	79.4
1.5	55	20.2	89.2	17.3	84.4	14.4	79.5	22.1	89.2	18.9	84.4	15.8	79.5	24.0	89.3	20.6	84.4	17.2	79.5
2	55	16.4	89.4	14.1	84.5	11.7	79.6	17.9	89.4	15.4	84.5	12.8	79.6	19.6	89.4	16.8	84.5	14.0	79.6
2.5	55	13.9	89.5	11.9	84.6	9.9	79.7	15.2	89.5	13.0	84.6	10.9	79.7	16.6	89.5	14.2	84.6	11.9	79.7

Fluid Temp = temperature of the chilled water (F).
Heat Gain (Btu per linear foot of pipe) calculated from Equation C-67.

Table App. A-45. Heat Gain Values for Pro 45 in Still Air Conditions

Nominal Insulation Thickness (inches)	Fluid Temp (F)	Pipe Size = 2", O.D. = 2.48"						Pipe Size = 3", O.D. = 3.54"						Pipe Size = 4", O.D. = 4.33"					
		Ambient Temperature (F)						Ambient Temperature (F)						Ambient Temperature (F)					
		90		85		80		90		85		80		90		85		80	
		Heat Gain	Surface Temp	Heat Gain	Surface Temp	Heat Gain	Surface Temp	Heat Gain	Surface Temp	Heat Gain	Surface Temp	Heat Gain	Surface Temp	Heat Gain	Surface Temp	Heat Gain	Surface Temp	Heat Gain	Surface Temp
0	35	51.6	40.3	46.9	39.9	42.2	39.4	70.8	42.3	64.4	41.6	58.0	40.9	83.8	43.8	76.2	43.0	68.6	42.2
0.125	35	33.2	61.0	30.2	58.6	27.2	56.2	45.3	61.5	41.2	59.0	37.0	56.7	53.8	62.0	48.9	59.5	44.0	57.1
0.25	35	25.0	70.0	22.7	66.8	20.4	63.7	33.8	70.0	30.7	66.9	27.6	63.7	40.1	70.2	36.4	67.0	32.8	63.8
0.375	35	20.3	75.0	18.4	71.4	16.6	67.7	27.3	74.8	24.8	71.2	22.3	67.6	32.3	74.8	29.3	71.2	26.4	67.6
0.5	35	17.3	78.1	15.7	74.2	14.1	70.3	23.0	77.9	20.9	74.0	18.8	70.1	27.2	77.8	24.7	73.9	22.2	70.1
0.625	35	15.1	80.3	13.8	76.2	12.4	72.1	20.1	80.0	18.3	75.9	16.4	71.8	23.6	79.9	21.5	75.8	19.3	71.7
0.75	35	13.6	81.8	12.3	77.6	11.1	73.3	17.9	81.5	16.3	77.3	14.6	73.1	21.0	81.4	19.1	77.2	17.2	73.0
1	35	11.4	83.9	10.4	79.5	9.3	75.0	14.9	83.6	13.5	79.2	12.2	74.7	17.4	83.4	15.8	79.0	14.2	74.6
1.25	35	10.0	85.2	9.1	80.6	8.2	76.1	12.9	84.9	11.7	80.4	10.5	75.8	15.0	84.8	13.6	80.2	12.2	75.7
1.5	35	8.9	86.1	8.1	81.5	7.3	76.8	11.4	85.8	10.4	81.2	9.4	76.6	13.2	85.7	12.0	81.1	10.8	76.5
2	35	7.6	87.2	6.9	82.5	6.2	77.7	9.5	87.0	8.7	82.2	7.8	77.5	11.0	86.8	10.0	82.1	9.0	77.4
2.5	35	6.7	87.9	6.1	83.1	5.5	78.2	8.3	87.7	7.6	82.9	6.8	78.1	9.5	87.6	8.6	82.8	7.8	78.0
0	40	46.9	44.9	42.2	44.4	37.5	43.9	64.4	46.6	58.0	45.9	51.5	45.3	76.2	48	68.6	47.2	61.0	46.4
0.125	40	30.2	63.6	27.2	61.2	24.1	58.9	41.2	64.0	37.0	61.7	32.9	59.3	48.9	64.5	44.0	62.1	39.1	59.6
0.25	40	22.7	71.8	20.4	68.7	18.2	65.4	30.7	71.9	27.6	68.7	24.6	65.5	36.4	72.0	32.8	68.8	29.2	65.6
0.375	40	18.4	76.4	16.6	72.7	14.8	69.1	24.8	76.2	22.3	72.6	19.8	69.0	29.3	76.2	26.4	72.6	23.5	69.0
0.5	40	15.7	79.2	14.1	75.3	12.6	71.4	20.9	79.0	18.8	75.1	16.8	71.2	24.7	78.9	22.2	75.1	19.8	71.1
0.625	40	13.8	81.2	12.4	77.1	11.0	73.0	18.3	80.9	16.4	76.8	14.6	72.7	21.5	80.8	19.3	76.7	17.2	72.6
0.75	40	12.3	82.6	11.1	78.3	9.9	74.1	16.3	82.3	14.6	78.1	13.0	73.8	19.1	82.2	17.2	78.0	15.3	73.7
1	40	10.4	84.5	9.3	80.0	8.3	75.6	13.5	84.2	12.2	79.7	10.8	75.3	15.8	84.0	14.2	79.6	12.6	75.2
1.25	40	9.1	85.6	8.2	81.1	7.3	76.5	11.7	85.4	10.5	80.8	9.4	76.3	13.6	85.2	12.2	80.7	10.9	76.2
1.5	40	8.1	86.5	7.3	81.8	6.5	77.2	10.4	86.2	9.4	81.6	8.3	77.0	12.0	86.1	10.8	81.5	9.6	76.9
2	40	6.9	87.5	6.2	82.7	5.5	78.0	8.7	87.2	7.8	82.5	6.9	77.8	10.0	87.1	9.0	82.4	8.0	77.7
2.5	40	6.1	88.1	5.5	83.2	4.9	78.4	7.6	87.9	6.8	83.1	6.1	78.3	8.6	87.8	7.8	83.0	6.9	78.2
0	45	42.2	49.4	37.5	48.9	32.8	48.4	58.0	50.9	51.5	50.3	45.1	49.6	68.6	52.2	61.0	51.4	53.3	50.6
0.125	45	27.2	66.2	24.1	63.9	21.1	61.5	37.0	66.7	32.9	64.3	28.8	61.9	44.0	67.1	39.1	64.6	34.2	62.2
0.25	45	20.4	73.7	18.2	70.4	15.9	67.3	27.6	73.7	24.6	70.5	21.5	67.3	32.8	73.8	29.2	70.6	25.5	67.4
0.375	45	16.6	77.7	14.8	74.1	12.9	70.5	22.3	77.6	19.8	74.0	17.3	70.4	26.4	77.6	23.5	74.0	20.5	70.4
0.5	45	14.1	80.3	12.6	76.4	11.0	72.5	18.8	80.1	16.8	76.2	14.7	72.3	22.2	80.1	19.8	76.1	17.3	72.3
0.625	45	12.4	82.1	11.0	78.0	9.6	73.9	16.4	81.8	14.6	77.7	12.8	73.6	19.3	81.7	17.2	77.6	15.0	73.6
0.75	45	11.1	83.3	9.9	79.1	8.6	74.8	14.6	83.1	13	78.8	11.4	74.6	17.2	83.0	15.3	78.7	13.4	74.5
1	45	9.3	85.0	8.3	80.6	7.3	76.1	12.2	84.7	10.8	80.3	9.5	75.9	14.2	84.6	12.6	80.2	11.0	75.9
1.25	45	8.2	86.1	7.3	81.5	6.3	77.0	10.5	85.8	9.4	81.3	8.2	76.8	12.2	85.7	10.9	81.2	9.5	76.7
1.5	45	7.3	86.8	6.5	82.2	5.7	77.5	9.4	86.6	8.3	82.0	7.3	77.3	10.8	86.5	9.6	81.9	8.4	77.3
2	45	6.2	87.7	5.5	83.0	4.8	78.2	7.8	87.5	6.9	82.8	6.1	78.1	9.0	87.4	8.0	82.7	7.0	78.0
2.5	45	5.5	88.2	4.9	83.4	4.3	78.6	6.8	88.1	6.1	83.3	5.3	78.5	7.8	88.0	6.9	83.2	6.0	78.5
0	50	37.5	53.9	32.8	53.4	28.1	53.0	51.5	55.3	45.1	54.6	38.6	54.0	61.0	56.4	53.3	55.6	45.7	54.8
0.125	50	24.1	68.9	21.1	66.5	18.1	64.2	32.9	69.3	28.8	66.9	24.7	64.4	39.1	69.6	34.2	67.2	29.3	64.7
0.25	50	18.2	75.4	15.9	72.3	13.6	69.1	24.6	75.5	21.5	72.3	18.4	69.1	29.2	75.6	25.5	72.4	21.9	69.2
0.375	50	14.8	79.1	12.9	75.5	11.1	71.8	19.8	79.0	17.3	75.4	14.9	71.7	23.5	79.0	20.5	75.4	17.6	71.7
0.5	50	12.6	81.4	11.0	77.5	9.4	73.6	16.8	81.2	14.7	77.3	12.6	73.4	19.8	81.1	17.3	77.3	14.8	73.4
0.625	50	11.0	83.0	9.6	78.9	8.3	74.7	14.6	82.7	12.8	78.6	11.0	74.5	17.2	82.6	15.0	78.6	12.9	74.5
0.75	50	9.9	84.1	8.6	79.8	7.4	75.6	13.0	83.8	11.4	79.6	9.8	75.4	15.3	83.7	13.4	79.5	11.5	75.3
1	50	8.3	85.6	7.3	81.1	6.2	76.7	10.8	85.3	9.5	80.9	8.1	76.5	12.6	85.2	11.0	80.9	9.5	76.4
1.25	50	7.3	86.5	6.3	82.0	5.4	77.4	9.4	86.3	8.2	81.8	7.0	77.2	10.9	86.2	9.5	81.7	8.2	77.1
1.5	50	6.5	87.2	5.7	82.5	4.9	77.9	8.3	87.0	7.3	82.3	6.2	77.7	9.6	86.9	8.4	82.3	7.2	77.7
2	50	5.5	88.0	4.8	83.2	4.1	78.5	6.9	87.8	6.1	83.1	5.2	78.4	8.0	87.7	7.0	83.0	6.0	78.3
2.5	50	4.9	88.4	4.3	83.6	3.6	78.9	6.1	88.3	5.3	83.5	4.5	78.7	6.9	88.2	6.0	83.5	5.2	78.7
0	55	32.8	58.4	28.1	58.0	23.5	57.4	45.1	59.6	38.6	59.0	32.2	58.3	53.3	60.6	45.7	59.8	38.1	59.0
0.125	55	21.1	71.5	18.1	69.2	15.1	66.8	28.8	71.9	24.7	69.4	20.6	67.0	34.2	72.2	29.3	69.7	24.4	67.3
0.25	55	15.9	77.3	13.6	74.1	11.3	70.9	21.5	77.3	18.4	74.1	15.4	70.9	25.5	77.4	21.9	74.2	18.2	71.0
0.375	55	12.9	80.5	11.1	76.8	9.2	73.2	17.3	80.4	14.9	76.7	12.4	73.1	20.5	80.4	17.6	76.7	14.7	73.1
0.5	55	11.0	82.5	9.4	78.6	7.8	74.6	14.7	82.3	12.6	78.4	10.5	74.5	17.3	82.3	14.8	78.4	12.4	74.4
0.625	55	9.6	83.9	8.3	79.7	6.9	75.6	12.8	83.6	11	79.5	9.1	75.5	15.0	83.6	12.9	79.5	10.7	75.4
0.75	55	8.6	84.8	7.4	80.6	6.2	76.3	11.4	84.6	9.8	80.4	8.1	76.2	13.4	84.5	11.5	80.3	9.5	76.1
1	55	7.3	86.1	6.2	81.7	5.2	77.2	9.5	85.9	8.1	81.5	6.8	77.1	11.0	85.9	9.5	81.4	7.9	77.0
1.25	55	6.3	87.0	5.4	82.4	4.5	77.8	8.2	86.8	7	82.2	5.8	77.7	9.5	86.7	8.2	82.1	6.8	77.6
1.5	55	5.7	87.5	4.9	82.9	4.1	78.2	7.3	87.3	6.2	82.7	5.2	78.1	8.4	87.3	7.2	82.7	6.0	78.0
2	55	4.8	88.2	4.1	83.5	3.4	78.7	6.1	88.1	5.2	83.4	4.3	78.6	7.0	88.0	6.0	83.3	5.0	78.6
2.5	55	4.3	88.6	3.6	83.9	3.0	79.0	5.3	88.5	4.5	83.7	3.8	78.6	6.0	88.5	5.2	83.7	4.4	78.9

Fluid Temp = temperature of the chilled water (F).
Heat Gain (Btu per linear foot of pipe) calculated from Equation C-67.



Table App. A-45. Heat Gain Values for Pro 45 in Still Air Conditions (continued)

Nominal Insulation Thickness (inches)	Fluid Temp (F)	Pipe Size = 6", O.D. = 6.29"						Pipe Size = 8", O.D. = 7.87"						Pipe Size = 10", O.D. = 9.84"					
		Ambient Temperature (F)						Ambient Temperature (F)						Ambient Temperature (F)					
		90		85		80		90		85		80		90		85		80	
		Heat Gain	Surface Temp	Heat Gain	Surface Temp	Heat Gain	Surface Temp	Heat Gain	Surface Temp	Heat Gain	Surface Temp	Heat Gain	Surface Temp	Heat Gain	Surface Temp	Heat Gain	Surface Temp	Heat Gain	Surface Temp
0	35	114.0	46.7	103.6	45.7	93.3	44.6	135.7	48.8	123.4	47.6	111.0	46.3	159.3	51.4	144.9	49.8	130.4	48.4
0.125	35	74.0	63.0	67.2	60.5	60.5	57.9	89.1	63.8	81.0	61.2	72.9	58.6	106.5	64.8	96.8	62.1	87.1	59.4
0.25	35	56.2	70.6	50.2	67.3	45.2	64.1	66.8	70.9	60.8	67.7	54.7	64.4	80.4	71.4	73.1	68.1	65.8	64.8
0.375	35	44.4	74.9	40.4	71.3	36.3	67.7	53.8	75.1	48.9	71.5	44.0	67.8	64.9	75.4	59.0	71.7	53.1	68.0
0.5	35	37.3	77.8	33.9	73.9	30.5	70.0	45.2	77.6	41.1	73.9	37.0	70.0	54.6	78.0	49.6	74.1	44.7	70.2
0.625	35	32.3	79.8	29.4	75.7	26.4	71.6	39.1	79.8	35.6	75.7	32.0	71.6	47.3	79.8	43.0	75.7	38.7	71.7
0.75	35	28.6	81.2	26.0	70.7	23.4	72.8	34.6	81.2	31.4	77.0	28.3	72.8	41.8	81.2	38.0	77.0	34.2	72.8
1	35	23.5	83.2	21.3	78.9	19.2	74.5	28.3	83.2	25.7	78.8	23.1	74.4	34.1	83.1	31.0	78.7	27.9	74.4
1.25	35	20.1	84.5	18.2	80.1	16.4	75.5	24.1	84.5	21.9	80.0	19.7	75.5	29.0	84.4	26.4	79.9	23.7	75.4
1.5	35	17.6	85.6	16.0	80.9	14.4	76.3	21.1	85.4	19.2	80.8	17.3	76.2	25.3	85.3	23.0	80.7	20.7	76.2
2	35	14.4	86.7	13.1	82.0	11.8	77.3	17.1	86.6	15.6	81.9	14.0	77.2	20.5	86.5	18.6	81.8	16.7	77.1
2.5	35	12.4	87.4	11.2	82.6	10.1	77.9	14.6	87.3	13.3	82.5	11.9	77.8	17.4	87.2	15.8	82.5	14.2	77.7
0	40	103.6	60.7	93.3	49.6	82.9	48.5	123.4	52.6	111.0	51.3	98.7	50.1	144.9	54.8	130.4	53.4	115.9	51.9
0.125	40	67.2	65.5	60.5	62.9	53.8	60.4	81.0	66.2	72.9	63.6	64.8	60.9	96.8	67.1	87.1	64.4	77.4	61.7
0.25	40	50.2	72.3	45.2	69.1	40.2	65.9	60.8	72.7	54.7	69.4	48.6	66.1	73.1	73.1	65.8	69.8	58.5	66.5
0.375	40	40.4	76.3	36.3	72.7	32.3	69.0	48.9	76.5	44.0	72.8	39.1	69.2	59.0	76.7	53.1	73.0	47.2	69.4
0.5	40	33.9	78.9	30.5	75.0	27.1	71.1	41.1	78.9	37.0	75.3	2.9	71.1	49.6	79.1	44.7	75.2	39.7	71.3
0.625	40	29.4	80.7	26.4	76.6	23.5	72.6	35.6	80.7	32.0	76.6	28.4	72.6	43.0	80.7	38.7	76.7	34.4	72.6
0.75	40	26.0	82.0	23.4	77.8	20.8	73.6	31.4	82	28.3	77.8	25.1	73.6	38.0	82	34.2	77.8	30.4	73.6
1	40	21.3	83.9	19.2	79.5	17.1	75.1	25.7	81.8	23.1	79.4	20.6	75.0	31.0	83.7	27.9	79.4	24.8	75.0
1.25	40	18.2	85.1	16.4	80.5	14.6	76.0	21.9	80.5	19.7	80.5	17.5	76.0	26.4	84.9	23.7	80.4	21.1	75.9
1.5	40	16.0	85.9	14.4	81.3	12.8	76.7	19.2	85.8	17.3	81.2	15.3	76.6	23.0	85.7	20.7	81.2	18.4	76.6
2	40	13.1	87.0	11.8	82.3	10.5	77.6	15.6	86.9	14.0	82.2	12.5	77.5	18.6	86.8	16.7	82.1	14.9	77.4
2.5	40	11.2	87.6	10.1	82.9	9.0	78.1	13.3	87.5	11.9	82.8	10.6	78.0	15.8	87.5	14.2	82.7	12.6	78.0
0	45	93.3	54.6	82.9	63.5	72.5	52.5	111.0	56.3	98.7	56.1	86.4	53.8	130.4	58.4	115.9	56.9	101.4	55.4
0.125	45	60.5	67.9	53.8	65.4	47.1	62.8	72.9	68.6	64.8	65.9	56.7	63.3	87.1	69.4	77.4	66.7	67.7	64.0
0.25	45	45.2	74.1	40.2	70.9	35.2	67.6	54.7	74.4	48.6	71.1	42.5	67.9	65.8	74.8	58.5	71.5	51.2	68.2
0.375	45	36.3	77.7	32.3	74.0	28.3	70.4	44.0	77.8	39.1	74.2	34.2	70.5	53.1	78.0	47.2	74.4	41.3	70.7
0.5	45	30.6	80.0	27.1	76.1	23.7	72.2	37.0	80.0	32.9	76.1	28.8	72.2	44.7	80.2	39.7	76.3	34.7	72.4
0.625	45	26.4	81.6	23.5	77.6	20.6	73.5	32.0	81.6	28.4	77.6	24.9	73.5	38.7	81.7	34.4	77.6	30.1	73.5
0.75	45	23.4	82.8	20.8	78.6	18.2	74.4	28.3	82.8	25.1	78.6	22.0	74.4	34.2	82.8	30.4	78.6	26.6	74.4
1	45	19.2	84.5	17.1	80.1	14.9	75.7	23.1	84.4	20.6	80.0	18.0	75.6	27.9	84.4	24.8	80.0	21.7	75.6
1.25	45	16.4	85.5	14.6	81.0	12.8	76.5	19.7	85.5	17.5	81.0	15.3	76.5	23.7	85.4	21.1	80.9	18.4	76.4
1.5	45	14.4	86.3	12.8	81.7	11.2	77.1	17.3	86.2	15.3	81.6	13.4	77.1	20.7	86.2	18.4	81.6	16.1	77.0
2	45	11.8	87.3	10.5	82.6	9.2	77.9	14.0	87.2	12.5	82.5	10.9	77.8	16.7	87.1	14.9	82.4	13.0	77.8
2.5	45	10.1	87.9	9.0	83.1	7.9	78.3	11.9	87.8	10.6	83.0	9.3	78.3	14.2	87.7	12.6	83.0	11.0	78.2
0	50	82.9	58.5	72.5	57.5	62.2	56.4	98.7	60.1	86.4	58.8	74.0	57.6	115.9	61.9	101.4	60.4	86.9	58.9
0.125	50	53.8	70.4	47.1	67.8	40.3	65.3	64.8	70.9	56.7	68.3	48.6	65.7	77.4	71.7	67.7	89.0	58.1	66.3
0.25	50	40.2	75.9	35.2	72.6	30.1	69.4	48.6	76.1	42.5	72.9	36.5	69.6	58.5	76.5	51.2	73.2	43.9	69.9
0.375	50	32.3	79.0	28.3	75.4	24.2	71.8	39.1	79.2	34.2	75.5	29.3	71.9	47.2	79.4	41.3	75.7	35.4	72.0
0.5	50	27.1	81.1	23.7	77.2	20.4	73.3	32.9	81.1	28.8	77.2	24.6	73.4	39.7	81.3	34.7	77.4	29.8	73.4
0.625	50	23.5	82.6	20.6	78.5	17.6	74.4	28.4	82.6	24.9	78.5	21.3	74.4	34.4	82.6	30.1	78.5	25.8	74.4
0.75	50	20.8	83.6	18.2	79.4	15.6	75.2	25.1	83.6	22.0	79.4	18.9	75.2	30.4	83.6	26.6	79.4	22.8	75.2
1	50	17.1	85.1	14.9	80.7	12.8	76.3	20.6	85.0	18.0	80.6	15.4	76.3	24.8	85.0	21.7	80.6	18.6	76.2
1.25	50	14.6	86.0	12.8	81.5	10.9	77.0	17.5	86.0	15.3	81.5	13.1	77.0	21.1	85.9	18.4	81.4	15.8	76.9
1.5	50	12.8	86.7	11.2	82.1	9.6	77.5	15.3	86.6	13.4	82.1	11.5	77.5	18.4	86.6	16.1	82.0	13.8	77.4
2	50	10.5	87.6	9.2	82.9	7.9	78.2	12.5	87.5	10.9	82.8	9.3	78.1	14.9	87.4	13.0	82.8	11.2	78.1
2.5	50	9.0	88.1	7.9	83.3	6.7	78.6	10.6	88.0	9.3	83.3	8.0	78.5	12.6	88.0	11.0	83.2	9.5	78.5
0	55	72.5	62.5	62.2	61.4	51.8	60.3	86.4	63.8	74	62.6	61.7	61.3	101.4	65.4	86.9	63.9	72.4	62.4
0.125	55	47.1	72.8	40.3	70.3	33.6	67.7	56.7	73.3	48.6	70.7	40.5	68.1	67.7	74.0	58.1	71.3	48.4	68.5
0.25	55	35.2	77.6	30.1	74.4	25.1	71.2	42.5	77.9	36.5	74.6	30.4	71.3	51.2	78.2	43.9	74.9	36.5	71.6
0.375	55	28.3	80.4	24.2	76.8	20.2	73.2	34.2	80.5	29.3	78.9	24.4	73.2	41.3	80.7	35.4	77.0	29.5	73.3
0.5	55	23.7	82.2	20.4	78.3	17.0	74.4	28.8	82.2	24.6	78.4	20.5	74.5	34.7	82.4	29.8	78.4	24.8	74.5
0.625	55	20.8	83.5	17.6	79.4	14.7	75.3	24.9	83.5	21.3	79.4	17.8	75.3	30.1	83.5	25.8	79.4	21.5	75.4
0.75	55	18.2	84.4	15.6	80.2	13.0	76.0	22.0	84.4	18.9	80.2	15.7	76.0	28.6	84.4	22.8	80.2	19.0	76.0
1	55	14.9	85.7	12.8	81.3	10.7	76.9	16.0	85.6	15.4	81.3	12.9	76.9	21.7	85.6	18.6	81.2	15.5	76.9
1.25	55	12.8	86.5	10.9	82.0	9.1	77.5	15.3	86.5	13.1	82.0	10.9	77.5	18.4	86.4	15.8	81.9	13.2	77.4
1.5	55	11.2	87.1	9.6	82.5	8.0	77.9	13.4	87.1	11.5	82.5	9.6	77.9	16.1	87.0	13.8	82.4	11.5	77.9
2	55	9.2	87.9	7.9	83.2	6.6	78.5	10.9	87.8	9.3	83.1	7.8	78.4	13.0	87.8	11.2	83.1	9.3	78.4
2.5	55	7.9	88.3	6.7	83.6	5.6	78.6	9.3	88.3	8.0	83.5	6.6	78.8	11.0	88.2	9.5	83.5	7.9	78.7

Fluid Temp = temperature of the chilled water (F).
Heat Gain (Btu per linear foot of pipe) calculated from Equation C-67.

Table App. A-45. Heat Gain Values for Pro 45 in Still Air Conditions (continued)

Nominal Insulation Thickness (inches)	Fluid Temp (F)	Pipe Size = 12", O.D. = 12.4"						Pipe Size = 14", O.D. = 13.98"						Pipe Size = 18", O.D. = 15.75"					
		Ambient Temperature (F)						Ambient Temperature (F)						Ambient Temperature (F)					
		90		85		80		90		85		80		90		85		80	
		Heat Gain	Surface Temp	Heat Gain	Surface Temp	Heat Gain	Surface Temp	Heat Gain	Surface Temp	Heat Gain	Surface Temp	Heat Gain	Surface Temp	Heat Gain	Surface Temp	Heat Gain	Surface Temp	Heat Gain	Surface Temp
0	35	186.5	54.1	169.6	52.3	152.6	50.6	201.1	55.7	182.8	53.8	164.5	51.9	217.1	57.1	197.3	55.1	177.6	53.1
0.125	35	127.2	66	115.7	63.2	104.1	60.4	138.9	66.7	126.3	63.8	113.7	60.9	151.8	67.4	138.0	64.4	124.2	61.5
0.25	35	97.0	72	88.2	68.7	79.4	65.3	106.6	72.4	96.9	69.0	87.2	65.6	117.1	72.8	106.4	69.4	95.8	65.9
0.375	35	78.7	75.7	71.5	72.0	64.4	68.3	86.7	75.9	78.8	72.2	70.9	68.5	95.6	76.2	86.9	72.4	78.2	68.7
0.5	35	66.3	78.2	60.3	74.3	54.3	70.3	73.3	78.3	66.6	74.4	59.9	70.5	80.9	78.5	73.6	74.5	66.2	70.6
0.625	35	57.5	79.9	52.3	75.9	47.0	71.8	63.6	80.0	57.8	75.9	52.0	71.8	70.3	80.1	63.9	76.0	57.5	71.9
0.75	35	50.8	81.3	46.2	77.1	41.6	72.9	56.2	81.3	51.1	77.1	46.0	72.9	62.2	81.4	56.6	77.2	50.9	73.0
1	35	41.5	83.1	37.7	78.7	33.9	74.4	45.9	83.1	41.7	78.8	37.6	74.4	50.8	83.2	46.2	78.8	41.6	74.4
1.25	35	35.2	84.4	32.0	79.9	28.8	75.4	39.0	84.4	35.4	79.9	31.9	75.4	43.1	84.4	39.2	79.9	35.3	75.4
1.5	35	30.7	85.2	27.9	80.7	25.1	76.1	34.0	85.2	30.9	80.7	27.8	76.1	37.6	85.2	34.2	80.6	30.8	76.1
2	35	24.7	86.4	22.5	81.7	20.2	77.1	27.3	86.4	24.8	81.7	22.3	77.0	30.2	86.3	27.4	81.7	24.7	77.0
2.5	35	20.9	87.1	19.0	82.4	17.1	77.7	23.0	87.1	20.9	82.4	18.8	77.6	25.4	87.1	23.1	82.3	20.8	77.6
040	40	169.6	57.3	152.6	55.6	135.7	53.9	182.8	58.8	164.5	56.9	146.2	55.0	197.3	60.1	177.6	58.1	157.9	56.1
0.125	40	115.7	68.2	104.1	65.4	92.5	62.5	126.3	68.8	113.7	65.9	101.0	63.1	138.0	69.4	124.2	66.5	110.4	63.5
0.25	40	88.2	73.7	79.4	70.3	70.5	67.0	96.9	74.0	87.2	70.6	77.5	67.2	106.4	74.4	95.8	70.9	85.1	67.5
0.375	40	71.5	77.0	64.4	73.3	57.2	69.6	78.8	77.2	70.9	73.5	63.0	69.8	86.9	77.4	78.2	73.7	69.5	69.9
0.5	40	60.3	79.3	54.3	75.3	48.2	71.4	66.6	79.4	59.9	75.5	53.3	71.5	73.6	79.5	66.2	75.6	58.8	71.6
0.625	40	52.3	80.9	47.0	76.8	41.8	72.7	57.8	80.9	52.0	76.8	46.2	72.8	63.9	81.0	57.5	76.9	51.1	72.8
0.75	40	46.2	82.1	41.6	77.9	37.0	73.6	51.1	82.1	46.0	77.9	40.9	73.7	56.6	82.2	50.9	78.0	45.3	73.7
1	40	37.7	83.7	33.9	79.4	30.2	75.0	41.7	83.8	37.6	79.4	33.4	75.0	46.2	83.8	41.6	79.4	37.0	75.0
1.25	40	32.0	84.9	28.8	80.4	25.6	75.9	35.4	84.9	31.9	80.4	28.3	75.9	39.2	84.9	35.3	80.4	31.4	75.9
1.5	40	27.9	85.7	25.1	81.1	22.3	76.5	30.9	85.7	27.8	81.1	24.7	76.5	34.2	85.6	30.8	81.1	27.4	76.5
2	40	22.5	86.7	20.2	82.1	18.0	77.4	24.8	86.7	22.3	82.0	19.8	77.4	27.4	86.7	24.7	82.0	21.9	77.4
2.5	40	19.0	87.4	17.1	82.7	15.2	77.9	20.9	87.4	18.8	82.6	16.7	77.9	23.1	87.3	20.8	82.6	18.5	77.9
0	45	152.6	60.6	135.7	58.9	118.7	57.1	164.5	61.9	146.2	60.0	128.0	58.1	177.6	63.1	157.9	61.1	138.1	59.1
0.125	45	104.1	70.4	92.5	67.5	81.0	64.7	113.7	70.9	101.0	68.1	88.4	65.2	124.2	71.5	110.4	68.5	96.6	65.6
0.25	45	79.4	75.3	70.5	72.0	61.7	68.6	87.2	75.6	77.5	72.2	67.8	68.8	95.8	75.9	85.1	72.5	74.5	69.1
0.375	45	64.4	78.3	57.2	74.6	50.1	70.9	70.9	78.5	63.0	74.8	55.2	71.1	78.2	78.7	69.5	74.9	60.8	71.2
0.5	45	54.3	80.3	48.2	76.4	42.2	72.5	59.9	80.5	53.3	76.5	46.6	72.6	66.2	80.6	58.8	76.6	51.5	72.7
0.625	45	47.0	81.8	41.8	77.7	36.6	73.6	52.0	81.8	46.2	77.8	40.4	73.7	57.5	81.9	51.1	77.8	44.7	73.7
0.75	45	41.6	82.9	37.0	78.6	32.4	74.4	46.0	82.9	40.9	78.7	35.8	74.5	50.9	83.0	45.3	78.7	39.6	74.5
1	45	33.9	84.4	30.2	80.0	26.4	75.6	37.6	84.4	33.4	80.0	29.2	75.6	41.6	84.4	37.0	80.0	32.3	75.7
1.25	45	28.8	85.4	25.6	80.9	22.4	76.4	31.9	85.4	28.3	80.9	24.8	76.4	35.3	85.4	31.4	80.9	27.5	76.4
1.5	45	25.1	86.1	22.3	81.5	19.6	77.0	27.8	86.1	24.7	81.5	21.6	77.0	30.8	86.1	27.4	81.5	23.9	77.0
2	45	20.2	87.1	18.0	82.4	15.7	77.7	22.3	87.0	19.8	82.4	17.4	77.7	24.7	87.0	21.9	82.4	19.2	77.7
2.5	45	17.1	87.7	15.2	82.9	13.3	78.2	18.8	87.6	16.7	82.9	14.6	78.2	20.8	87.6	18.5	82.9	16.2	78.1
0	50	135.7	63.9	118.7	62.1	101.8	60.4	146.2	65.0	128.0	63.1	109.7	61.3	157.9	66.1	138.1	64.1	118.4	62.1
0.125	50	92.5	72.5	81.0	69.7	69.4	66.9	101.0	73.1	88.4	70.2	75.8	67.3	110.4	73.5	96.6	70.6	82.8	67.6
0.25	50	70.5	77.0	61.7	73.6	52.9	70.2	77.5	77.2	67.8	73.8	58.1	70.4	85.1	77.5	74.5	74.1	63.9	70.6
0.375	50	57.2	79.6	50.1	75.9	42.9	72.2	63.0	79.8	55.2	76.1	47.3	72.3	69.5	79.9	60.8	76.2	52.1	72.5
0.5	50	48.2	81.4	42.2	77.5	36.2	73.6	53.3	81.5	46.6	77.6	40.0	73.6	58.8	81.6	51.5	77.7	44.1	73.7
0.625	50	41.8	82.7	36.6	78.6	31.4	74.5	46.2	82.8	40.4	78.7	34.7	74.6	51.1	82.8	44.7	78.7	38.3	74.6
0.75	50	37.0	83.6	32.4	79.4	27.7	75.2	40.9	83.7	35.8	79.5	30.7	75.3	45.3	83.7	39.6	79.5	33.9	75.3
1	50	30.2	85.0	26.4	80.6	22.6	76.3	33.4	85.0	29.2	80.6	25.0	76.3	37.0	85.0	32.3	80.7	27.7	76.3
1.25	50	25.6	85.9	22.4	81.4	19.2	76.9	28.3	85.9	24.8	81.4	21.3	76.9	31.4	85.9	27.5	81.4	23.5	76.9
1.5	50	22.3	86.5	19.6	82.0	16.8	77.4	24.7	86.5	21.6	82.0	18.5	77.4	27.4	86.5	23.9	82.0	20.5	77.4
250	50	18.0	87.4	15.7	82.7	13.5	78.0	19.8	87.4	17.4	82.7	14.9	78.0	21.9	87.4	19.2	82.7	16.5	78.0
2.5	50	15.2	87.9	13.3	83.2	11.4	78.4	16.7	87.9	14.6	83.2	12.5	78.4	18.5	87.9	16.2	83.1	13.8	78.4
055	55	118.7	67.1	101.8	65.4	84.8	63.7	128.0	68.1	109.7	66.3	91.4	64.4	138.1	69.1	118.4	67.1	98.7	65.0
0.125	55	81.0	74.7	69.4	71.9	57.8	69.1	88.4	75.2	75.8	72.3	63.1	69.4	96.6	75.6	82.8	72.6	69.0	69.7
0.25	55	61.7	78.6	52.9	75.2	44.1	71.8	67.8	78.8	58.1	75.4	48.4	72.0	74.5	79.1	63.9	75.6	53.2	72.2
0.375	55	50.1	80.9	42.9	77.2	35.8	73.5	55.2	81.1	47.3	77.3	39.4	73.6	60.8	81.2	52.1	77.5	43.4	73.7
0.5	55	42.2	82.5	36.2	78.6	30.2	74.6	46.6	82.6	40.0	78.6	33.3	74.7	51.5	82.7	44.1	78.7	36.8	74.8
0.625	55	36.6	83.6	31.4	79.5	26.1	75.4	40.4	83.7	34.7	79.6	28.9	75.4	44.7	83.7	38.3	79.6	31.9	75.5
0.75	55	32.4	84.4	27.7	80.2	23.1	76.0	35.8	84.5	30.7	80.3	25.6	76.1	39.6	84.5	33.9	80.3	28.3	76.1
1	55	26.4	85.6	22.6	81.3	18.9	76.9	29.2	85.6	25.0	81.3	20.9	76.9	32.3	85.7	27.7	81.3	23.1	76.9
1.25	55	22.4	86.4	19.2	81.9	16.0	77.4	24.8	86.4	21.3	81.9	17.7	77.4	27.5	86.4	23.5	81.9	19.6	77.4
1.5	55	19.6	87.0	16.8	82.4	14.0	77.8	21.6	87.0	18.5	82.4	15.4	77.8	23.9	87.0	20.5	82.4	17.1	77.8
2	55	15.7	87.7	13.5	83.0	11.2	78.4	17.4	87.7	14.9	83.0	12.4	78.4	19.2	87.7	16.5	83.0	13.7	78.3
2.5	55	13.3	88.2	11.4	83.4	9.5	78.7	14.6	88.2	12.5	83.4	10.5	78.7	16.2	88.1	13.8	83.4	11.5	78.7

Fluid Temp = temperature of the chilled water (F).
Heat Gain (Btu per linear foot of pipe) calculated from Equation C-67.

Table App. A-45. Heat Gain Values for Pro 45 in Still Air Conditions (continued)

Nominal Insulation Thickness (inches)	Fluid Temp (F)	Pipe Size = 18", O.D. = 17.72"						Pipe Size = 20", O.D. = 19.69"						Pipe Size = 24", O.D. = 24.8"					
		Ambient Temperature (F)						Ambient Temperature (F)						Ambient Temperature (F)					
		90		85		80		90		85		80		90		85		80	
		Heat Gain	Surface Temp	Heat Gain	Surface Temp	Heat Gain	Surface Temp	Heat Gain	Surface Temp	Heat Gain	Surface Temp	Heat Gain	Surface Temp	Heat Gain	Surface Temp	Heat Gain	Surface Temp	Heat Gain	Surface Temp
0	35	232.2	58.7	211.0	56.6	189.9	54.4	246.6	60.1	224.2	57.8	201.8	55.5	276.4	63.4	251.3	60.8	226.2	58.2
0.125	35	164.6	68.1	149.6	65.1	134.7	62.1	177.0	68.8	160.9	65.7	144.8	62.7	204.5	70.5	185.9	67.3	167.3	64.1
0.25	35	127.9	73.2	116.3	69.8	104.6	66.3	138.4	73.6	125.8	70.1	113.2	66.6	162.6	74.7	147.8	71.1	133.0	67.5
0.375	35	104.8	76.5	95.3	72.7	85.8	68.9	113.9	76.7	103.5	72.9	93.2	69.1	135.2	77.4	122.9	73.5	110.6	69.7
0.5	35	89.0	78.7	80.9	74.7	72.8	70.7	96.9	78.8	88.1	74.8	79.3	70.8	115.8	79.3	105.3	75.3	94.8	71.2
0.625	35	77.4	80.3	70.4	76.1	63.4	72.0	84.5	80.4	76.8	76.2	69.1	72.1	101.4	80.7	92.2	76.6	83.0	72.4
0.75	35	68.6	81.5	62.4	77.2	56.2	73.0	75.0	81.6	68.1	77.3	61.3	73.1	90.3	81.8	82.1	77.5	73.9	73.3
1	35	56.1	83.2	51.0	78.8	45.9	74.4	61.4	83.2	55.8	78.9	50.2	74.5	74.3	83.4	67.5	79.0	60.8	74.6
1.25	35	47.7	84.4	43.3	79.9	39.0	75.4	52.1	84.4	47.4	79.9	42.7	75.4	63.3	84.5	57.5	80.0	51.8	75.5
1.5	35	41.5	85.2	37.8	80.6	34.0	76.1	45.4	85.2	41.3	80.7	37.2	76.1	55.2	85.3	50.2	80.7	45.2	76.1
2	35	33.3	86.3	30.3	81.7	27.2	77.0	36.4	86.3	33.1	81.7	29.8	77.0	44.2	86.3	40.2	81.7	36.2	77.0
2.5	35	28.0	87.1	25.4	82.3	22.9	77.6	30.6	87.0	27.8	82.3	25.0	77.6	37.1	87.0	33.7	82.3	30.4	77.6
0	40	211.0	61.6	189.9	59.4	168.8	57.3	224.2	62.8	201.8	60.5	179.3	58.3	251.3	65.8	226.2	63.2	201.0	60.7
0.125	40	149.6	70.1	134.7	67.1	119.7	64.1	160.9	70.7	144.8	67.7	128.7	64.6	185.9	72.3	167.3	69.1	148.7	65.8
0.25	40	116.3	74.8	104.6	71.3	93.0	67.8	125.8	75.1	113.2	71.6	100.6	68.1	147.8	76.1	133.0	72.5	118.2	68.8
0.375	40	95.3	77.7	85.8	73.9	76.2	70.2	103.5	77.9	93.2	74.1	82.8	70.3	122.9	78.5	110.6	74.7	98.3	70.8
0.5	40	80.9	79.7	72.8	75.7	64.7	71.7	88.1	79.8	79.3	75.8	70.5	71.9	105.3	80.3	94.8	76.2	84.2	72.2
0.625	40	70.4	81.1	63.4	77.0	56.3	72.9	76.8	81.2	69.1	77.1	61.4	73.0	92.2	81.6	83.0	77.4	73.8	73.2
0.75	40	62.4	82.2	56.2	78.0	49.9	73.8	68.1	82.3	61.3	78.1	54.5	73.9	82.1	82.5	73.9	78.3	65.7	74.0
1	40	51.0	83.8	45.9	79.4	40.8	75.1	55.8	83.9	50.2	79.5	44.6	75.1	67.5	84.0	60.8	79.6	54.0	75.2
1.25	40	43.3	84.9	39.0	80.4	34.7	75.9	47.4	84.9	42.7	80.4	37.9	75.9	57.5	85.0	51.8	80.5	46.0	76.0
1.5	40	37.8	85.6	34.0	81.1	30.2	76.5	41.3	85.7	37.2	81.1	33.1	76.5	50.2	85.7	45.2	81.1	40.1	76.6
2	40	30.3	86.7	27.2	82.0	24.2	77.3	33.1	86.7	29.8	82.0	26.5	77.3	40.2	86.7	36.2	82.0	32.2	77.3
2.5	40	25.4	87.3	22.9	82.6	20.4	77.9	27.8	87.3	25.0	82.6	22.2	77.9	33.7	87.3	30.4	82.6	27.0	77.8
0	45	189.9	64.4	168.8	62.3	147.7	60.1	201.8	65.5	179.3	63.3	156.9	61.0	226.2	68.2	201.0	65.7	175.9	63.1
0.125	45	134.7	72.1	119.7	69.1	104.7	66.1	144.8	72.7	128.7	69.6	112.6	66.5	167.3	74.1	148.7	70.8	130.1	67.6
0.25	45	104.6	76.3	93.0	72.8	81.4	69.3	113.2	76.6	100.6	73.1	88.1	69.6	133.0	77.5	118.2	73.8	103.5	70.2
0.375	45	85.8	78.9	76.2	75.2	66.7	71.4	93.2	79.1	82.8	75.3	72.5	71.5	110.6	79.7	98.3	75.8	86.0	72.0
0.5	45	72.8	80.7	64.7	76.7	56.6	72.8	79.3	80.8	70.5	76.9	61.7	72.9	94.8	81.2	84.2	77.2	73.7	73.2
0.625	45	63.4	82.0	56.3	77.9	49.3	73.8	69.1	82.1	61.4	78.0	53.7	73.9	83.0	82.4	73.8	78.2	64.6	74.1
0.75	45	56.2	83.0	49.9	78.8	43.7	74.6	61.3	83.1	54.5	78.9	47.7	74.6	73.9	83.3	65.7	79.0	57.5	74.8
1	45	45.9	84.4	40.8	80.1	35.7	75.7	50.2	84.5	44.6	80.1	39.1	75.7	60.8	84.6	54.0	80.2	47.3	75.8
1.25	45	39.0	85.4	34.7	80.9	30.3	76.4	42.7	85.4	37.9	80.9	33.2	76.4	51.8	85.5	46.0	81.0	40.3	76.5
1.5	45	34.0	86.1	30.2	81.5	26.4	77.0	37.2	86.1	33.1	81.5	28.9	77.0	45.2	86.1	40.1	81.6	35.1	77.0
2	45	27.2	87.0	24.2	82.3	21.2	77.7	29.8	87.0	26.5	82.3	23.2	77.7	36.2	87.0	32.2	82.3	28.2	77.7
2.5	45	22.9	87.6	20.4	82.9	17.8	78.1	25.0	87.6	22.2	82.9	19.5	78.1	30.4	87.6	27.0	82.8	23.6	78.1
0	50	168.8	67.3	147.7	65.1	126.6	62.9	179.3	68.3	156.9	66.0	134.5	63.7	201.0	70.7	175.9	68.1	150.8	65.5
0.125	50	119.7	74.1	104.7	71.1	89.8	68.1	128.7	74.6	112.6	71.5	96.5	68.4	148.7	75.8	130.1	72.6	111.5	69.4
0.25	50	93.0	77.8	81.4	74.3	69.8	70.9	100.6	78.1	88.1	74.6	75.5	71.1	118.2	78.8	103.5	75.2	88.7	71.6
0.375	50	76.2	80.2	66.7	76.4	57.2	72.6	82.8	80.3	72.5	76.5	62.1	72.7	98.3	80.8	86.0	77.0	73.7	73.1
0.5	50	64.7	81.7	56.6	77.8	48.5	73.8	70.5	81.9	61.7	77.9	52.9	73.9	84.2	82.2	73.7	78.2	63.2	74.2
0.625	50	56.3	82.9	49.3	78.8	42.2	74.7	61.4	83.0	53.7	78.9	46.1	74.7	73.8	83.2	64.6	79.1	55.3	74.9
0.75	50	49.9	83.8	43.7	79.6	37.4	75.4	54.5	83.9	47.7	79.6	40.9	75.4	65.7	84.0	57.5	79.8	49.3	75.5
1	50	40.8	85.1	35.7	80.7	30.6	76.3	44.6	85.1	39.1	80.7	33.5	76.3	54.0	85.2	47.3	80.8	40.5	76.4
1.25	50	34.7	85.9	30.3	81.4	26.0	76.9	37.9	85.9	33.2	81.4	28.4	76.9	46.0	86.0	40.3	81.5	34.5	77
1.5	50	30.2	86.5	26.4	82.0	22.7	77.4	33.1	86.5	28.9	82.0	24.8	77.4	40.1	86.6	35.1	82.0	30.1	77.4
2	50	24.2	87.3	21.2	82.7	18.2	78.0	26.5	87.3	23.2	82.7	19.9	78.0	32.2	87.3	28.2	82.7	24.1	78
2.5	50	20.4	87.9	17.8	83.1	15.3	78.4	22.2	87.9	19.5	83.1	16.7	78.4	27.0	87.8	23.6	83.1	20.2	78.4
0	55	147.7	70.1	126.6	67.9	105.5	65.8	156.9	71.0	134.5	68.7	112.1	66.4	175.9	73.1	150.8	70.5	125.6	67.9
0.125	55	104.7	76.1	89.8	73.1	74.8	70.1	112.6	76.5	96.5	73.4	80.4	70.4	130.1	77.6	111.5	74.4	92.9	71.1
0.25	55	81.4	79.3	69.8	75.9	58.1	72.4	88.1	79.6	75.5	76.1	62.9	72.6	103.5	80.2	88.7	76.6	73.9	73
0.375	55	66.7	81.4	57.2	77.6	47.6	73.8	72.5	81.5	62.1	77.7	51.8	73.9	86.0	82.0	73.7	78.1	61.4	74.3
0.5	55	56.6	82.8	48.5	78.8	40.5	74.8	61.7	82.9	52.9	78.9	44.0	74.9	73.7	83.2	63.2	79.2	52.6	75.1
0.625	55	49.3	83.8	42.2	79.7	35.2	75.6	53.7	83.9	46.1	79.7	38.4	75.6	64.6	84.1	55.3	79.9	46.1	75.8
0.75	55	43.7	84.6	37.4	80.4	31.2	76.1	47.7	84.6	40.9	80.4	34.1	76.2	57.5	84.8	49.3	80.5	41.1	76.3
1	55	35.7	85.7	30.6	81.3	25.5	76.9	39.1	85.7	33.5	81.3	27.9	76.9	47.3	85.8	40.5	81.4	33.8	77
1.25	55	30.3	86.4	26.0	81.9	21.7	77.4	33.2	86.4	28.4	81.9	23.7	77.5	40.3	86.5	34.5	82.0	28.8	77.5
1.5	55	26.4	87.0	22.7	82.4	18.9	77.8	28.9	87.0	24.8	82.4	20.7	77.8	35.1	87.0	30.1	82.4	25.1	77.8
2	55	21.2	87.7	18.2	83.0	15.1	78.3	23.2	87.7	19.9	83.0	16.5	78.3	28.2	87.7	24.1	83.0	20.1	78.3
2.5	55	17.8	88.1	15.3	83.4	12.7	78.7	19.5	88.1	16.7	83.4	13.9	78.7	23.6	88.1	20.2	83.4	16.9	78.6

Fluid Temp = temperature of the chilled water (F).
Heat Gain (Btu per linear foot of pipe) calculated from Equation C-67.

Table App. A-46. Heat Gain Values for Pro 45 in Moving Air Conditions

Nominal Insulation Thickness (inches)	Fluid Temp (F)	Pipe Size = 2", O.D. = 2.48						Pipe Size = 3", O.D. = 3.54"						Pipe Size = 4", O.D. = 4.33"					
		Ambient Temperature (F)						Ambient Temperature (F)						Ambient Temperature (F)					
		90		85		80		90		85		80		90		85		80	
		Heat Gain	Surface Temp	Heat Gain	Surface Temp	Heat Gain	Surface Temp	Heat Gain	Surface Temp	Heat Gain	Surface Temp	Heat Gain	Surface Temp	Heat Gain	Surface Temp	Heat Gain	Surface Temp	Heat Gain	Surface Temp
0	35	152.7	50.8	138.8	49.4	125.0	47.9	195.1	54.9	177.3	53.1	159.6	51.3	218.4	57.9	198.5	55.8	178.7	53.7
0.125	35	54.1	77.4	49.2	73.5	44.3	69.7	73.1	77.7	66.4	73.8	59.8	70.0	85.8	78.1	78.0	74.2	70.2	70.2
0.25	35	34.0	82.7	30.9	78.4	27.8	74.1	46.1	82.7	41.9	78.4	37.7	74.1	54.5	82.8	49.5	78.5	44.6	74.1
0.375	35	25.4	85.0	23.0	80.5	20.7	75.9	34.2	84.9	31.1	80.4	28.0	75.8	40.4	84.9	36.8	80.4	33.1	75.9
0.5	35	20.5	86.2	18.6	81.6	16.8	76.9	27.5	86.1	25.0	81.5	22.5	76.8	32.5	86.1	29.5	81.5	26.6	76.8
0.625	35	17.4	87.0	15.8	82.3	14.2	77.6	23.2	86.9	21.1	82.2	19.0	77.5	27.3	86.9	24.8	82.2	22.4	77.4
0.75	35	15.2	87.6	13.9	82.8	12.5	78.0	20.2	87.4	18.3	82.7	16.5	77.9	23.7	87.4	21.6	82.6	19.4	77.9
1	35	12.4	88.2	11.3	83.4	10.2	78.6	16.2	88.1	14.8	83.3	13.3	78.5	19.0	88.1	17.3	83.3	15.6	78.4
1.25	35	10.7	88.6	9.7	83.8	8.7	78.9	13.8	88.5	12.5	83.7	11.3	78.8	16.1	88.5	14.6	83.6	13.2	78.8
1.5	35	9.4	88.9	8.6	84.0	7.7	79.1	12.1	88.8	11.0	83.9	9.9	79.0	14.0	88.8	12.8	83.9	11.5	79.0
2	35	7.9	89.2	7.1	84.3	6.4	79.4	9.9	89.2	9.0	84.2	8.1	79.3	11.4	89.1	10.4	84.2	9.4	79.3
2.5	35	6.9	89.4	6.3	84.5	5.6	79.5	8.6	89.4	7.8	84.4	7.0	79.5	9.8	89.3	8.9	84.4	8.0	79.5
0	40	138.8	54.4	125.0	52.9	111.1	51.5	177.3	58.1	159.6	56.3	141.9	54.5	198.5	60.8	178.7	58.7	158.8	56.7
0.125	40	49.2	78.5	44.3	74.7	39.4	70.8	66.4	78.8	59.8	75.0	53.1	71.1	78.0	79.2	70.2	75.2	62.4	71.3
0.25	40	30.9	83.4	27.8	79.1	24.7	74.7	41.9	83.4	37.7	79.1	33.5	74.7	49.5	83.5	44.6	79.1	39.6	74.8
0.375	40	23	85.5	20.7	80.9	18.4	76.4	31.1	85.4	28.0	80.8	24.8	76.3	36.8	85.4	33.1	80.9	29.4	76.3
0.5	40	18.6	86.6	16.8	81.9	14.9	77.3	25.0	86.5	22.5	81.8	20.0	77.2	29.5	86.5	26.6	81.8	23.6	77.2
0.625	40	15.8	87.3	14.2	82.6	12.7	77.8	21.1	87.2	19.0	82.5	16.8	77.8	24.8	87.2	22.4	82.4	19.9	77.7
0.75	40	13.9	87.8	12.5	83.0	11.1	78.2	18.3	87.7	16.5	82.9	14.7	78.1	21.6	87.6	19.4	82.9	17.3	78.1
1	40	11.3	88.4	10.2	83.6	9.0	78.7	14.8	88.3	13.3	83.5	11.8	78.6	17.3	88.3	15.6	83.4	13.8	78.6
1.25	40	9.7	88.8	8.7	83.9	7.7	79.0	12.5	88.7	11.3	83.8	10.0	78.9	14.6	88.6	13.2	83.8	11.7	78.9
1.5	40	8.6	89.0	7.7	84.1	6.9	79.2	11.0	88.9	9.9	84.0	8.8	79.1	12.8	88.9	11.5	84.0	10.2	79.1
2	40	7.1	89.3	6.4	84.4	5.7	79.4	9.0	89.2	8.1	84.3	7.2	79.4	10.4	89.2	9.4	84.3	8.3	79.4
2.5	40	6.3	89.5	5.6	84.5	5.0	79.6	7.8	89.4	7.0	84.5	6.2	79.5	8.9	89.4	8.0	84.5	7.1	79.5
0	45	125.0	57.9	111.1	56.5	97.2	55.0	159.6	61.3	141.9	59.5	124.1	57.7	178.7	63.7	158.8	61.7	139.0	59.6
0.125	45	44.3	79.7	39.4	75.8	34.5	72.0	59.8	80.0	53.1	76.1	46.5	72.2	70.2	80.2	62.4	76.3	54.6	72.4
0.25	45	27.8	84.1	24.7	79.7	21.7	75.4	37.7	84.1	33.5	79.7	29.3	75.4	44.6	84.1	39.6	79.8	34.7	75.4
0.375	45	20.7	85.9	18.4	81.4	16.1	76.8	28.0	85.8	24.8	81.3	21.7	76.8	33.1	85.9	29.4	81.3	25.7	76.8
0.5	45	16.8	86.9	14.9	82.3	13.0	77.6	22.5	86.8	20.0	82.2	17.5	77.5	26.6	86.8	23.6	82.2	20.7	77.5
0.625	45	14.2	87.6	12.7	82.8	11.1	78.1	19.0	87.5	16.8	82.8	14.7	78	22.4	87.4	19.9	82.7	17.4	78.0
0.75	45	12.5	88.0	11.1	83.2	9.7	78.4	16.5	87.9	14.7	83.1	12.8	78.4	19.4	87.9	17.3	83.1	15.1	78.4
1	45	10.2	88.6	9.0	83.7	7.9	78.9	13.3	88.5	11.8	83.6	10.3	78.8	15.6	88.4	13.8	83.6	12.1	78.8
1.25	45	8.7	88.9	7.7	84.0	6.8	79.1	11.3	88.8	10.0	83.9	8.8	79.1	13.2	88.8	11.7	83.9	10.2	79.0
1.5	45	7.7	89.1	6.9	84.2	6.0	79.3	9.9	89.0	8.8	84.1	7.7	79.3	11.5	89.0	10.2	84.1	8.9	79.2
2	45	6.4	89.4	5.7	84.4	5.0	79.5	8.1	89.3	7.2	84.4	6.3	79.5	9.4	89.3	8.3	84.4	7.3	79.4
2.5	45	5.6	89.5	5.0	84.6	4.4	79.6	7.0	89.5	6.2	84.5	5.5	79.6	8.0	89.5	7.1	84.5	6.2	79.6
0	50	111.1	61.5	97.2	60.0	83.3	58.6	141.9	64.5	124.1	62.7	106.4	60.9	158.8	66.7	139.0	64.6	119.1	62.5
0.125	50	39.4	80.8	34.5	77.0	29.5	73.1	53.1	81.1	46.5	77.2	39.9	73.3	62.4	81.3	54.6	77.4	46.8	73.5
0.25	50	24.7	84.7	21.7	80.4	18.6	76.0	33.5	84.7	29.3	80.4	25.1	76	39.6	84.8	34.7	80.4	29.7	76.1
0.375	50	18.4	86.4	16.1	81.8	13.8	77.3	24.8	86.3	21.7	81.8	18.6	77.2	29.4	86.3	25.7	81.8	22.1	77.2
0.5	50	14.9	87.3	13.0	82.6	11.2	78.0	20.0	87.2	17.5	82.5	15.0	77.9	23.6	87.2	20.7	82.5	17.7	77.9
0.625	50	12.7	87.8	11.1	83.1	9.5	78.4	16.8	87.8	14.7	83.0	12.6	78.3	19.9	87.7	17.4	83.0	14.9	78.3
0.75	50	11.1	88.2	9.7	83.4	8.3	78.7	14.7	88.1	12.8	83.4	11.0	78.6	17.3	88.1	15.1	83.4	12.9	78.6
1	50	9.0	88.7	7.9	83.9	6.8	79.0	11.8	88.6	10.3	83.8	8.9	79	13.8	88.6	12.1	83.8	10.4	79.0
1.25	50	7.7	89.0	6.8	84.1	5.8	79.3	10.0	88.9	8.8	84.1	7.5	79.2	11.7	88.9	10.2	84.0	8.8	79.2
1.5	50	6.9	89.2	6.0	84.3	5.1	79.4	8.8	89.1	7.7	84.3	6.6	79.4	10.2	89.1	8.9	84.2	7.7	79.3
2	50	5.7	89.4	5.0	84.5	4.3	79.6	7.2	89.4	6.3	84.5	5.4	79.5	8.3	89.4	7.3	84.4	6.2	79.5
2.5	50	5.0	89.6	4.4	84.6	3.8	79.7	6.2	89.5	5.5	84.6	4.7	79.6	7.1	89.5	6.2	84.6	5.4	79.6
0	55	97.2	65.0	83.3	63.6	69.4	62.2	124.1	67.7	106.4	65.9	88.7	64.0	139.0	69.6	119.1	67.5	99.3	65.4
0.125	55	34.5	82.0	29.5	78.1	24.6	74.3	46.5	82.2	39.9	78.3	33.2	74.4	54.6	82.4	46.8	78.5	39.0	74.6
0.25	55	21.7	85.4	18.6	81.0	15.5	76.7	29.3	85.4	25.1	81.0	20.9	76.7	34.7	85.4	29.7	81.1	24.8	76.7
0.375	55	16.1	86.8	13.8	82.3	11.5	77.7	21.7	86.8	18.6	82.2	15.5	77.7	25.7	86.8	22.1	82.2	18.4	77.7
0.5	55	13.0	87.6	11.2	83.0	9.3	78.3	17.5	87.5	15.0	82.9	12.5	78.2	20.7	87.5	17.7	82.9	14.8	78.2
0.625	55	11.1	88.1	9.5	83.4	7.9	78.7	14.7	88.0	12.6	83.3	10.5	78.6	17.4	88.0	14.9	83.3	12.4	78.6
0.75	55	9.7	88.4	8.3	83.7	6.9	78.9	12.8	88.4	11.0	83.6	9.2	78.8	15.1	88.4	12.9	83.6	10.8	78.8
1	55	7.9	88.9	6.8	84.0	5.6	79.2	10.3	88.8	8.9	84.0	7.4	79.1	12.1	88.8	10.4	84.0	8.6	79.1
1.25	55	6.8	89.1	5.8	84.3	4.8	79.4	8.8	89.1	7.5	84.2	6.3	79.3	10.2	89.0	8.8	84.2	7.3	79.3
1.5	55	6.0	89.3	5.1	84.4	4.3	79.5	7.7	89.3	6.6	84.4	5.5	79.5	8.9	89.2	7.7	84.3	6.4	79.4
2	55	5.0	89.5	4.3	84.6	3.6	79.6	6.3	89.5	5.4	84.5	4.5	79.6	7.3	89.4	6.2	84.5	5.2	79.6
2.5	55	4.4	89.6	3.8	84.7	3.1	79.7	5.5	89.6	4.7	84.6	3.9	79.7	6.2	89.6	5.4	84.6	4.5	79.7

Fluid Temp = temperature of the chilled water (F).
Heat Gain (Btu per linear foot of pipe) calculated from Equation C-67.

Table App. A-46. Heat Gain Values for Pro 45 in Moving Air Conditions (continued)

Nominal Insulation Thickness (inches)	Fluid Temp (F)	Pipe Size = 6", O.D. = 6.29"						Pipe Size = 8", O.D. = 7.87"						Pipe Size = 10", O.D. = 9.84"					
		Ambient Temperature (F)						Ambient Temperature (F)						Ambient Temperature (F)					
		90		85		80		90		85		80		90		85		80	
		Heat Gain	Surface Temp	Heat Gain	Surface Temp	Heat Gain	Surface Temp	Heat Gain	Surface Temp	Heat Gain	Surface Temp	Heat Gain	Surface Temp	Heat Gain	Surface Temp	Heat Gain	Surface Temp	Heat Gain	Surface Temp
0	35	114.0	46.7	103.6	45.7	93.3	44.6	300.9	65.7	273.6	62.9	246.2	60.1	328.9	68.7	299.0	65.7	269.1	62.6
0.125	35	74.0	62.0	67.2	60.5	60.5	57.9	137.0	79.3	124.5	75.2	112.1	71.2	160.3	79.9	145.7	75.8	131.2	71.7
0.25	35	55.2	70.6	50.2	67.3	45.2	64.1	89.6	83.2	81.5	78.8	73.3	74.4	106.9	83.4	97.1	79.0	87.4	74.6
0.375	35	44.4	74.9	40.4	71.3	36.3	67.7	67.1	85.0	61.0	80.5	54.9	75.9	80.6	85.2	73.3	80.6	66.0	76.0
0.5	35	37.3	77.8	33.9	73.9	30.5	70.0	53.9	86.1	49.0	81.5	44.1	76.8	65.0	86.2	59.1	81.5	53.2	76.9
0.625	35	32.3	79.8	29.4	75.7	26.4	71.6	45.3	86.8	41.2	82.1	37.1	77.4	54.7	86.9	49.7	82.1	44.7	77.4
0.75	35	28.6	81.2	26.0	77.0	23.4	72.8	39.2	87.3	35.6	82.6	32.1	77.8	47.3	87.3	43.0	82.6	38.7	77.8
1	35	23.5	83.2	21.3	78.9	19.2	74.5	31.1	88.0	28.3	83.2	25.5	78.4	37.5	88.0	34.1	83.2	30.7	78.3
1.25	35	20.1	84.5	18.2	80.1	16.4	75.5	26.0	88.4	23.6	83.6	21.3	78.7	31.3	88.4	28.5	83.5	25.6	78.7
1.5	35	17.6	85.5	16.0	80.0	14.4	76.3	22.5	88.7	20.5	83.8	18.4	78.9	27.0	88.7	24.6	83.8	22.1	78.9
2	35	14.4	86.7	13.1	82.0	11.8	77.3	18.0	89.0	16.3	84.1	14.7	79.2	21.5	89.0	19.5	84.1	17.6	79.2
2.5	35	12.4	87.4	11.2	82.6	10.1	77.9	15.1	89.3	13.8	84.3	12.4	79.4	18.0	89.2	16.4	84.3	14.7	79.4
0	40	103.6	50.7	93.3	49.6	82.9	48.5	273.6	67.9	246.2	65.1	218.9	62.3	299.0	70.7	269.1	67.6	239.2	64.5
0.125	40	67.2	65.5	60.5	62.9	53.8	60.4	124.5	80.2	112.1	76.2	99.6	72.2	145.7	80.8	131.2	76.7	116.6	72.6
0.25	40	50.2	72.3	45.2	69.1	40.2	65.9	81.5	83.8	73.3	79.4	65.2	75.0	97.1	84.0	87.4	79.6	77.7	75.2
0.375	40	40.4	76.3	36.3	72.7	32.3	69.0	61.0	85.5	54.9	80.9	48.8	76.4	73.3	85.6	66.0	81.0	58.6	76.5
0.5	40	33.9	78.9	30.5	75.0	27.1	71.1	49.0	86.5	44.1	81.8	39.2	77.2	59.1	86.5	53.2	81.9	47.3	77.2
0.625	40	29.4	80.7	26.4	76.6	23.5	72.6	41.2	87.1	37.1	82.4	32.9	77.7	49.7	87.1	44.7	82.4	39.8	77.7
0.75	40	26.0	82.0	23.4	77.8	20.8	73.6	35.6	87.6	32.1	82.8	28.5	78.1	43.0	87.6	38.7	82.8	34.4	78.1
1	40	21.3	83.9	19.2	79.5	17.1	75.1	28.3	88.2	25.5	83.4	22.6	78.5	34.1	88.2	30.7	83.3	27.3	78.5
1.25	40	18.2	85.1	16.4	80.5	14.6	76.0	23.6	88.6	21.3	83.7	18.9	78.8	28.5	88.5	25.6	83.7	22.8	78.8
1.5	40	16.0	85.9	14.4	81.3	12.8	76.7	20.5	88.8	18.4	83.9	16.4	79.0	24.6	88.8	22.1	83.9	19.7	79.0
2	40	13.1	87.0	11.8	82.3	10.5	77.6	16.3	89.1	14.7	84.2	13.1	79.3	19.5	89.1	17.6	84.2	15.6	79.3
2.5	40	11.2	87.6	10.1	82.9	9.0	78.1	13.8	89.3	12.4	84.4	11.0	79.5	16.4	89.3	14.7	84.4	13.1	79.4
0	45	93.3	54.6	82.9	53.5	72.5	52.5	246.2	70.1	218.9	67.3	191.5	64.5	269.1	72.6	239.2	69.5	209.3	66.5
0.125	45	60.5	67.9	53.8	65.4	47.1	62.8	112.1	81.2	99.6	77.2	87.2	73.2	131.2	81.7	116.6	77.6	102.0	73.6
0.25	45	45.2	74.1	40.2	70.9	35.2	67.6	73.3	84.4	65.2	80.0	57.0	75.7	87.4	84.6	77.7	80.2	68.0	75.8
0.375	45	36.3	77.7	32.3	74.0	28.3	70.4	54.9	85.9	48.8	81.4	42.7	76.8	66.0	86.0	58.6	81.5	51.3	76.9
0.5	45	30.5	80.0	27.1	76.1	23.7	72.2	44.1	86.8	39.2	82.2	34.3	77.5	53.2	86.9	47.3	82.2	41.4	77.6
0.625	45	26.4	81.6	23.5	77.6	20.6	73.5	37.1	87.4	32.9	82.7	28.8	78.0	44.7	87.4	39.8	82.7	34.8	78.0
0.75	45	23.4	82.8	20.8	78.6	18.2	74.4	32.1	87.8	28.5	83.1	24.9	78.3	38.7	87.8	34.4	83.1	30.1	78.3
1	45	19.2	84.5	17.1	80.1	14.9	75.7	25.5	88.4	22.6	83.5	19.8	78.7	30.7	88.3	27.3	83.5	23.9	78.7
1.25	45	16.4	85.5	14.6	81.0	12.8	76.5	21.3	88.7	18.9	83.8	16.6	79.0	25.6	88.7	22.8	83.8	19.9	79.0
1.5	45	14.4	86.3	12.8	81.7	11.2	77.1	18.4	88.9	16.4	84.0	14.3	79.2	22.1	88.9	19.7	84.0	17.2	79.1
2	45	11.8	87.3	10.5	82.6	9.2	77.9	14.7	89.2	13.1	84.3	11.4	79.4	17.6	89.2	15.6	84.3	13.7	79.4
2.5	45	10.1	87.9	9.0	83.1	7.9	78.3	12.4	89.4	11.0	84.5	9.6	79.5	14.7	89.4	13.1	84.4	11.5	79.5
0	50	82.9	58.5	72.5	57.5	62.2	56.4	218.9	72.3	191.5	69.5	164.1	66.7	239.2	74.5	209.3	71.5	179.4	68.4
0.125	50	53.8	70.4	47.1	67.8	40.3	65.3	99.6	82.2	87.2	78.2	74.7	74.1	116.6	82.6	102.0	78.6	87.4	74.5
0.25	50	40.2	75.9	35.2	72.6	30.1	69.4	65.2	85.0	57.0	80.7	48.9	76.3	77.7	85.2	68.0	80.8	58.3	76.4
0.375	50	32.3	79.0	28.3	75.4	24.2	71.8	48.8	86.4	42.7	81.8	36.6	77.3	58.6	86.5	51.3	81.9	44.0	77.4
0.5	50	27.1	81.1	23.7	77.2	20.4	73.3	39.2	87.2	34.3	82.5	29.4	77.9	47.3	87.2	41.4	82.6	35.5	77.9
0.625	50	23.5	82.6	20.6	78.5	17.6	74.4	32.9	87.7	28.8	83.0	24.7	78.3	39.8	87.7	34.8	83.0	29.8	78.3
0.75	50	20.8	83.6	18.2	79.4	15.6	75.2	28.5	88.1	24.9	83.3	21.4	78.5	34.4	88.1	30.1	83.3	25.8	78.6
1	50	17.1	85.1	14.9	80.7	12.8	76.3	22.6	88.5	19.8	83.7	17.0	78.9	27.3	88.5	23.9	83.7	20.5	78.9
1.25	50	14.6	86.0	12.8	81.5	10.9	77.0	18.9	88.8	16.6	84.0	14.2	79.1	22.8	88.8	19.9	84.0	17.1	79.1
1.5	50	12.8	86.7	11.2	82.1	9.6	77.5	16.4	89.0	14.3	84.2	12.3	79.3	19.7	89.0	17.2	84.1	14.7	79.3
2	50	10.5	87.6	9.2	82.9	7.9	78.2	13.1	89.3	11.4	84.4	9.8	79.5	15.6	89.3	13.7	84.4	11.7	79.5
2.5	50	9.0	88.1	7.9	83.3	6.7	78.6	11.0	89.5	9.6	84.5	8.3	79.6	13.1	89.4	11.5	84.5	9.8	79.6
0	55	72.5	62.5	62.2	61.4	51.8	60.3	191.5	74.5	164.1	71.7	136.8	68.9	209.3	76.5	179.4	73.4	149.5	70.3
0.125	55	47.1	72.8	40.3	70.3	33.6	67.7	87.2	83.2	74.7	79.1	62.3	75.1	102.0	83.6	87.4	79.5	72.9	75.4
0.25	55	35.2	77.6	30.1	74.4	25.1	71.2	57.0	85.7	48.9	81.3	40.7	76.9	68.0	85.8	58.3	81.4	48.6	77.0
0.375	55	28.3	80.4	24.2	76.8	20.2	73.2	42.7	86.8	36.6	82.3	30.5	77.7	51.3	86.9	44.0	82.4	36.6	77.8
0.5	55	23.7	82.2	20.4	78.3	17.0	74.4	34.3	87.5	29.4	82.9	24.5	78.2	41.4	87.6	35.5	82.9	29.6	78.3
0.625	55	20.6	83.5	17.6	79.4	14.7	75.3	28.8	88.0	24.7	83.3	20.6	78.6	34.8	88.0	29.8	83.3	24.9	78.6
0.75	55	18.2	84.4	15.6	80.2	13.0	76.0	24.9	88.3	21.4	83.5	17.8	78.8	30.1	88.3	25.8	83.6	21.5	78.8
1	55	14.9	85.7	12.8	81.3	10.7	76.9	19.8	88.7	17.0	83.9	14.1	79.1	23.9	88.7	20.5	83.9	17.1	79.1
1.25	55	12.8	86.5	10.9	82.0	9.1	77.5	16.6	89.0	14.2	84.1	11.8	79.3	19.9	89.0	17.1	84.1	14.2	79.3
1.5	55	11.2	87.1	9.6	82.5	8.0	77.9	14.3	89.2	12.3	84.3	10.2	79.4	17.2	89.1	14.7	84.3	12.3	79.4
2	55	9.2	87.9	7.9	83.2	6.6	78.5	11.4	89.4	9.8	84.5	8.2	79.6	13.7	89.4	11.7	84.5	9.8	79.5
2.5	55	7.9	88.3	6.7	83.6	5.6	78.8	9.6	89.5	8.3	84.6	6.9	79.7	11.5	89.5	9.8	84.6	8.2	79.6

Fluid Temp = temperature of the chilled water (F).
Heat Gain (Btu per linear foot of pipe) calculated from Equation C-67.

Table App. A-46. Heat Gain Values for Pro 45 in Moving Air Conditions (continued)

Nominal Insulation Thickness (inches)	Fluid Temp (F)	Pipe Size = 12", O.D. = 12.4"						Pipe Size = 13", O.D. = 13.98"						Pipe Size = 16", O.D. = 15.75"					
		Ambient Temperature (F)						Ambient Temperature (F)						Ambient Temperature (F)					
		90		85		80		90		85		80		90		85		80	
		Heat Gain	Surface Temp	Heat Gain	Surface Temp	Heat Gain	Surface Temp	Heat Gain	Surface Temp	Heat Gain	Surface Temp	Heat Gain	Surface Temp	Heat Gain	Surface Temp	Heat Gain	Surface Temp	Heat Gain	Surface Temp
0	35	358.0	71.6	325.4	68.3	292.9	65.0	370.9	73.1	337.2	69.6	303.5	66.2	386.7	74.4	351.5	70.8	316.4	67.2
0.125	35	187.2	80.6	170.2	76.4	153.2	72.3	201.6	81.0	183.2	76.8	164.9	72.6	217.4	81.3	197.6	77.1	177.9	72.9
0.25	35	127.5	83.7	115.9	79.3	104.3	74.9	139.1	83.9	126.5	79.4	113.8	75.0	151.9	84.0	138.1	79.6	124.3	75.1
0.375	35	97.2	85.3	88.3	80.7	79.5	76.2	106.7	85.4	97.0	80.8	87.3	76.2	117.2	85.5	106.5	80.9	95.9	76.3
0.5	35	78.7	86.3	71.6	81.6	64.4	76.9	86.8	86.3	78.9	81.6	71.0	77.0	95.6	86.4	86.9	81.7	78.2	77.0
0.625	35	66.4	86.9	60.4	82.2	54.3	77.5	73.3	86.9	66.6	82.2	60.0	77.5	80.9	87.0	73.6	82.2	66.2	77.5
0.75	35	57.5	87.4	52.3	82.6	47.1	77.8	63.6	87.4	57.8	82.6	52.0	77.9	70.3	87.4	63.9	82.6	57.5	77.9
1	35	45.7	88.0	41.5	83.2	37.4	78.3	50.5	88.0	45.9	83.2	41.3	78.4	55.9	88.0	50.8	83.2	45.8	78.4
1.25	35	38.1	88.4	34.6	83.5	31.2	78.7	42.1	88.4	38.3	83.5	34.5	78.7	46.7	88.4	42.4	83.5	38.2	78.7
1.5	35	32.8	88.6	29.8	83.8	26.8	78.9	36.3	88.6	33.0	83.8	29.7	78.9	40.2	88.6	36.5	83.8	32.9	78.9
2	35	26.0	89.0	23.6	84.1	21.2	79.2	28.7	89.0	26.1	84.1	23.5	79.2	31.7	89.0	28.8	84.1	25.9	79.2
2.5	35	21.7	89.2	19.7	84.3	17.7	79.4	23.9	89.2	21.7	84.3	19.6	79.3	26.4	89.2	24.0	84.3	21.6	79.3
0	40	325.4	73.3	292.9	70.0	260.3	66.6	337.2	74.6	303.5	71.2	269.8	67.7	351.5	75.8	316.4	72.2	281.2	68.6
0.125	40	170.2	81.4	153.2	77.3	136.1	73.2	183.2	81.8	164.9	77.6	146.6	73.4	197.6	82.1	177.9	77.9	158.1	73.7
0.25	40	115.9	84.3	104.3	79.9	92.7	75.4	126.5	84.4	113.8	80.0	101.2	75.6	138.1	84.6	124.3	80.1	110.5	75.7
0.375	40	88.3	85.7	79.5	81.2	70.7	76.6	97.0	85.8	87.3	81.2	77.6	76.6	106.5	85.9	95.9	81.3	85.2	76.7
0.5	40	71.6	86.6	64.4	81.9	57.3	77.3	78.9	86.6	71.0	82.0	63.1	77.3	86.9	86.7	78.2	82.0	69.5	77.4
0.625	40	60.4	87.2	54.3	82.5	48.3	77.7	66.6	87.2	60.0	82.5	53.3	77.8	73.6	87.2	66.2	82.5	58.9	77.8
0.75	40	52.3	87.6	47.1	82.8	41.8	78.1	57.8	87.6	52.0	82.9	46.3	78.1	63.9	87.6	57.5	82.9	51.1	78.1
1	40	41.5	88.2	37.4	83.3	33.2	78.5	45.9	88.2	41.3	83.4	36.8	78.5	50.8	88.2	45.8	83.4	40.7	78.5
1.25	40	34.6	88.5	31.2	83.7	27.7	78.8	38.3	88.5	34.5	83.7	30.6	78.8	42.4	88.5	38.2	83.7	33.9	78.8
1.5	40	29.8	88.8	26.8	83.9	23.9	79.0	33.0	88.8	29.7	83.9	26.4	79.0	36.5	88.8	32.9	83.9	29.2	79.0
2	40	23.6	89.1	21.2	84.2	18.9	79.3	26.1	89.1	23.5	84.2	20.9	79.3	28.8	89.1	25.9	84.2	23.1	79.3
2.5	40	19.7	89.3	17.7	84.4	15.8	79.4	21.7	89.3	19.6	84.3	17.4	79.4	24.0	89.3	21.6	84.3	19.2	79.4
0	45	292.9	75.0	260.3	71.6	227.8	68.3	303.5	76.2	269.8	72.7	236.0	69.3	316.4	77.2	281.2	73.6	246.1	70.1
0.125	45	153.2	82.3	136.1	78.2	119.1	74.0	164.9	82.6	146.6	78.4	128.3	74.3	177.9	82.9	158.1	78.7	138.3	74.5
0.25	45	104.3	84.9	92.7	80.4	81.2	76.0	113.8	85.0	101.2	80.6	88.5	76.1	124.3	85.1	110.5	80.7	96.7	76.2
0.375	45	79.5	86.2	70.7	81.6	61.8	77.0	87.3	86.2	77.6	81.6	67.9	77.1	95.9	86.3	85.2	81.7	74.6	77.1
0.5	45	64.4	86.9	57.3	82.3	50.1	77.6	71.0	87.0	63.1	82.3	55.2	77.7	78.2	87.0	69.5	82.4	60.8	77.7
0.625	45	54.3	87.5	48.3	82.7	42.3	78.0	60.0	87.5	53.3	82.8	46.6	78.1	66.2	87.5	58.9	82.8	51.5	78.1
0.75	45	47.1	87.8	41.8	83.1	36.6	78.3	52.0	87.9	46.3	83.1	40.5	78.3	57.5	87.9	51.1	83.1	44.7	78.4
1	45	37.4	88.3	33.2	83.5	29.1	78.7	41.3	88.4	36.8	83.5	32.2	78.7	45.8	88.4	40.7	83.5	35.6	78.7
1.25	45	31.2	88.7	27.7	83.8	24.2	79.0	34.5	88.7	30.6	83.8	26.8	79	38.2	88.7	33.9	83.8	29.7	79.0
1.5	45	26.8	88.9	23.9	84.0	20.9	79.1	29.7	88.9	26.4	84.0	23.1	79.1	32.9	88.9	29.2	84.0	25.6	79.1
2	45	21.2	89.2	18.9	84.3	16.5	79.4	23.5	89.2	20.9	84.3	18.2	79.4	25.9	89.2	23.1	84.3	20.2	79.3
2.5	45	17.7	89.4	15.8	84.4	13.8	79.5	19.6	89.3	17.4	84.4	15.2	79.5	21.6	89.3	19.2	84.4	16.8	79.5
0	50	260.3	76.6	227.8	73.3	195.3	70.0	269.8	77.7	236.0	74.3	202.3	70.8	281.2	78.6	246.1	75.1	210.9	71.5
0.125	50	136.1	83.2	119.1	79.0	102.1	74.9	146.6	83.4	128.3	79.3	109.9	75.1	158.1	83.7	138.3	79.5	118.6	75.3
0.25	50	92.7	85.4	81.2	81.0	69.6	76.6	101.2	85.6	88.5	81.0	75.9	76.7	110.5	85.7	96.7	81.2	82.9	76.8
0.375	50	70.7	86.6	61.8	82.0	53.0	77.4	77.6	86.6	67.9	82.1	58.2	77.5	85.2	86.7	74.6	82.1	63.9	77.5
0.5	50	57.3	87.3	50.1	82.6	43.0	78.0	63.1	87.3	55.2	82.7	47.3	78.0	69.5	87.4	60.8	82.7	52.2	78.0
0.625	50	48.3	87.7	42.3	83.0	36.2	78.3	53.3	87.8	46.6	83.1	40.0	78.3	58.9	87.8	51.5	83.1	44.2	78.3
0.75	50	41.8	88.1	36.6	83.3	31.4	78.6	46.3	88.1	40.5	83.3	34.7	78.6	51.1	88.1	44.7	83.4	38.4	78.6
1	50	33.2	88.5	29.1	83.7	24.9	78.9	36.8	88.5	32.2	83.7	27.6	78.9	40.7	88.5	35.6	83.7	30.5	78.9
1.25	50	27.7	88.8	24.2	84.0	20.8	79.1	30.6	88.8	26.8	84.0	23.0	79.1	33.9	88.8	29.7	84.0	25.4	79.1
1.5	50	23.9	89.0	20.9	84.1	17.9	79.3	26.4	89.0	23.1	84.1	19.8	79.3	29.2	89.0	25.6	84.1	21.9	79.3
2	50	18.9	89.3	16.5	84.4	14.2	79.4	20.9	89.3	18.2	84.4	15.6	79.4	23.1	89.3	20.2	84.3	17.3	79.4
2.5	50	15.8	89.4	13.8	84.5	11.8	79.6	17.4	89.4	15.2	84.5	13.0	79.6	19.2	89.4	16.8	84.5	14.4	79.6
0	55	227.8	78.3	195.3	75.0	162.7	71.6	236.0	79.3	202.3	75.8	168.6	72.3	246.1	80.1	210.9	76.5	175.8	72.9
0.125	55	119.1	84.0	102.1	79.9	85.1	75.7	128.3	84.3	109.9	80.1	91.6	75.9	138.3	84.5	118.6	80.3	98.8	76.1
0.25	55	81.2	86.0	69.6	81.6	58.0	77.1	88.5	86.1	75.9	81.7	63.2	77.2	96.7	86.2	82.9	81.8	69.0	77.3
0.375	55	61.8	87.0	53.0	82.4	44.2	77.9	67.9	87.1	58.2	82.5	48.5	77.9	74.6	87.1	63.9	82.5	53.3	77.9
0.5	55	50.1	87.6	43.0	83.0	35.8	78.3	55.2	87.7	47.3	83.0	39.4	78.3	60.8	87.7	52.2	83.0	43.5	78.3
0.625	55	42.3	88.0	36.2	83.3	30.2	78.6	46.6	88.1	40.0	83.3	33.3	78.6	51.5	88.1	44.2	83.3	36.8	78.6
0.75	55	36.6	88.3	31.4	83.6	26.2	78.8	40.5	88.3	34.7	83.6	28.9	78.8	44.7	88.4	38.4	83.6	32.0	78.8
1	55	29.1	88.7	24.9	83.9	20.8	79.1	32.2	88.7	27.6	83.9	23.0	79.1	35.6	88.7	30.5	83.9	25.4	79.1
1.25	55	24.2	89.0	20.8	84.1	17.3	79.3	26.8	89.0	23.0	84.1	19.2	79.3	29.7	89.0	25.4	84.1	21.2	79.3
1.5	55	20.9	89.1	17.9	84.3	14.9	79.4	23.1	89.1	19.8	84.3	16.5	79.4	25.6	89.1	21.9	84.3	18.3	79.4
2	55	16.5	89.4	14.2	84.4	11.8	79.5	18.2	89.4	15.6	84.4	13.0	79.5	20.2	89.3	17.3	84.4	14.4	79.5
2.5	55	13.8	89.5	11.8	84.6	9.9	79.6	15.2	89.5	13.0	84.6	10.9	79.6	16.8	89.5	14.4	84.6	12.0	79.6

Fluid Temp = temperature of the chilled water (F).
Heat Gain (Btu per linear foot of pipe) calculated from Equation C-67.



This page intentionally left blank.

GENERAL ENGINEERING TABLES

Contents

Prism Load Values	App. B-2
Marston Soil Load Values	App. B-3
E'Modulus	App. B-11
Bedding Constant	App. B-11

Table B-1. Prism Load Values for Asahi/Americ Pipe

Height (feet)	Soil Wt (lb/ft ³)	Nom. O.D. Act. O.D.	0.50 0.79	0.75 0.98	1 1.26	1.25 1.58	1.5 1.97	2 2.48	2.5 2.95	3 3.54	4 4.33	6 6.29	8 7.87	10 9.84	12 12.4	14 13.98	16 15.75	18 17.72	20 19.69	24 24.8
3	100		19.8	24.5	31.5	39.5	49.3	62.0	73.7	88.5	108.3	157.3	196.8	246.0	310.0	349.5	393.8	443	492.2	620.0
3	110		21.7	27.0	34.7	43.5	54.2	68.2	81.1	97.4	119.1	173.0	216.4	270.6	341.0	384.5	433.1	487.3	541.5	682.0
3	120		23.7	29.4	37.8	47.4	59.1	74.4	88.5	106.2	129.9	188.7	236.1	295.2	372.0	419.4	472.5	531.6	590.7	744.0
3	125		24.7	30.6	39.4	49.4	61.6	77.5	92.2	110.6	135.3	196.6	245.9	307.5	387.5	436.9	492.2	553.8	615.3	775.0
3	130		25.7	31.9	41.0	51.4	64.0	80.6	95.9	115.1	140.7	204.4	255.8	319.8	403.0	454.4	511.9	575.9	639.9	806.0
4	100		26.3	32.7	42.0	52.7	65.7	82.7	98.3	118.0	144.3	209.7	262.3	328.0	413.3	466.0	525.0	590.7	656.3	826.7
4	110		29.0	35.9	46.2	57.9	72.2	90.9	108.2	129.8	158.8	230.6	288.6	360.8	454.7	512.6	577.5	649.7	722.0	909.3
4	120		31.6	39.2	50.4	63.2	78.8	99.2	118.0	141.6	173.2	251.6	314.8	393.6	496.0	559.2	630.0	708.8	787.6	992.0
4	125		32.9	40.8	52.5	65.8	82.1	103.3	122.9	147.5	180.4	262.1	327.9	410.0	516.7	582.5	656.3	736.3	820.4	1033.3
4	130		34.2	42.5	54.6	68.5	85.4	107.5	127.8	153.4	187.6	272.6	341.0	426.4	537.3	605.8	682.5	767.9	853.2	1074.7
5	100		32.9	40.8	52.5	65.8	82.1	103.3	122.9	147.5	180.4	262.1	327.9	410.0	516.7	582.5	656.3	738.3	820.4	1033.3
5	110		36.2	44.9	57.8	72.4	90.3	113.7	135.2	162.3	198.5	288.3	360.7	451.0	568.3	640.8	721.9	812.2	902.5	1136.7
5	120		39.5	49.0	63.0	79.0	98.5	124.0	147.5	177.0	216.5	314.5	393.5	492.0	620.0	699.0	787.5	886.0	984.5	1240.0
5	125		41.1	51.0	65.6	82.3	102.6	129.2	153.6	184.4	225.5	327.6	409.9	512.5	645.8	728.1	820.3	922.9	1025.5	1291.7
5	130		42.8	53.1	68.3	85.6	106.7	134.3	159.8	191.8	234.5	340.7	426.3	533.0	671.7	757.3	853.1	959.8	1066.5	1343.3
6	100		39.5	49.0	63.0	79.0	98.5	124.0	147.5	177.0	216.5	314.5	393.5	492.0	620.0	699.0	787.5	886.0	984.5	1240.0
6	110		43.4	53.9	69.3	86.9	108.3	136.4	162.2	194.7	238.1	345.9	432.8	541.2	682.0	768.9	866.3	974.6	1082.9	1364.0
6	120		47.4	58.8	75.6	94.8	118.2	148.8	177.0	212.4	259.8	377.4	472.2	590.4	744.0	838.8	945.0	1063.2	1181.4	1488.0
6	125		49.4	61.2	78.8	98.7	123.1	155.0	184.4	221.3	270.6	393.1	491.9	615.0	775.0	873.8	984.4	1107.5	1230.6	1550.0
6	130		51.3	63.7	81.9	102.7	128.0	161.2	191.7	230.1	281.4	408.8	511.5	639.6	806.0	908.7	1023.8	1151.8	1279.8	1612.0
7	100		46.1	57.2	73.5	92.2	114.9	144.7	172.1	206.5	252.6	366.9	459.1	574.0	723.3	815.5	918.8	1033.7	1148.6	1446.7
7	110		50.7	62.9	80.9	101.4	126.4	159.1	189.3	227.2	277.8	403.6	505.0	631.4	795.7	897.1	1010.6	1137.0	1263.4	1591.3
7	120		55.3	68.6	88.2	110.6	137.9	173.6	206.5	247.8	303.1	440.3	550.9	688.8	868.0	978.6	1102.5	1240.4	1378.3	1736.0
7	125		57.6	71.5	91.9	115.2	143.6	180.8	215.1	258.1	315.7	458.6	573.9	717.5	904.2	1019.4	1148.4	1292.1	1435.7	1808.3
7	130		59.9	74.3	95.6	119.8	149.4	188.1	223.7	268.5	328.4	477.0	596.8	746.2	940.3	1060.2	1194.4	1343.8	1493.2	1880.7
8	100		52.7	65.3	84.0	105.3	131.3	165.3	196.7	236.0	288.7	419.3	524.7	656.0	826.7	932.0	1050.0	1181.3	1312.7	1653.3
8	110		57.9	71.9	92.4	115.9	144.5	181.9	216.3	259.6	317.5	461.3	577.1	721.6	909.3	1025.2	1155.0	1299.5	1443.9	1818.7
8	120		63.2	78.4	100.8	126.4	157.6	198.4	236.0	283.2	346.4	503.2	629.6	787.2	992.0	1118.4	1260.0	1417.6	1575.2	1984.0
8	125		65.8	81.7	105.0	131.7	164.2	206.7	245.8	295.0	360.8	524.2	655.8	820.0	1033.3	1165.0	1312.5	1476.7	1640.8	2066.7
8	130		68.5	84.9	109.2	136.9	170.7	214.9	255.7	306.8	373.5	545.1	682.1	852.8	1074.7	1211.6	1365.0	1535.7	1706.5	2149.3
9	100		59.2	73.5	94.5	118.5	147.7	186.0	221.2	265.5	324.7	471.7	590.2	738.0	930.0	1048.5	1181.3	1329.0	1476.7	1860.0
9	110		65.2	80.8	104.0	130.3	162.5	204.6	243.4	292.1	357.2	518.9	649.3	811.8	1023.0	1153.4	1299.4	1461.9	1624.4	2046.0
9	120		71.1	88.2	113.4	142.2	177.3	223.2	265.5	318.6	369.7	566.1	708.3	885.6	1116.0	1258.2	1417.5	1594.8	1772.1	2232.0
9	125		74.1	91.9	118.1	148.1	184.7	232.5	276.6	331.9	405.9	589.7	737.8	922.5	1162.5	1310.6	1476.6	1661.2	1845.9	2325.0
9	130		77.0	95.5	122.9	154.0	192.1	241.8	287.6	345.2	422.2	613.3	767.3	959.4	1209.0	1363.1	1535.6	1727.7	1919.8	2418.0
10	100		65.8	81.7	105.0	131.7	164.2	206.7	245.8	295.0	360.8	524.2	655.8	820.0	1033.3	1165.0	1312.5	1476.7	1640.8	2066.7
10	110		72.4	89.8	115.5	144.8	180.6	227.3	270.4	324.5	396.9	576.6	721.4	902.0	1136.7	1281.5	1443.8	1624.3	1804.9	2273.3
10	120		79.0	98.0	126.0	158.0	197.0	248.0	295.0	354.0	433.0	629.0	787.0	984.0	1240.0	1398.0	1575.0	1772.0	1969.0	2480.0
10	125		82.3	102.1	131.3	164.6	205.2	258.3	307.3	368.8	451.0	655.2	819.8	1025.0	1291.7	1458.3	1640.6	1845.8	2051.0	2583.3
10	130		85.6	106.2	136.5	171.2	213.4	268.7	319.6	383.5	469.1	681.4	852.6	1066.0	1343.3	1514.5	1706.3	1919.7	2133.1	2686.7
15	100		98.7	122.5	157.5	197.5	246.2	310.0	368.7	442.5	541.2	786.2	983.7	1230.0	1550.0	1747.5	1968.8	2215.0	2461.2	3100.0
15	110		108.6	134.7	173.3	217.2	270.9	341.0	405.6	486.8	595.4	864.9	1082.1	1353.0	1705.0	1922.3	2165.6	2436.5	2707.4	3410.0
15	120		118.5	147.0	189.0	237.0	295.5	372.0	442.5	531.0	649.5	943.5	1180.5	1478.0	1860.0	2097.0	2362.5	2658.0	2953.5	3720.0
15	125		123.4	153.1	198.9	246.9	307.8	387.5	460.9	553.1	676.6	982.8	1229.7	1537.5	1937.5	2184.4	2460.9	2768.7	3076.6	3875.0
15	130		128.4	159.2	204.8	256.7	320.1	403.0	479.4	575.3	703.6	1022.1	1278.9	1599.0	2015.0	2271.8	2559.4	2879.5	3199.6	4030.0
20	100		131.7	163.3	210.0	263.3	328.3	413.3	491.7	590.0	721.7	1048.3	1311.7	1640.0	2066.7	2330.0	2625.0	2953.3	3281.7	4133.3
20	110		144.8	179.7	231.0	289.7	361.2	454.7	540.8	649.0	793.8	1153.2	1442.8	1804.0	2273.3	2563.0	2887.5	3248.7	3609.8	4546.7
20	120		158.0	196.0	252.0	316.0	394.0	496.0	590.0	708.0	866.0	1258.0	1574.0	1968.0	2480.0	2796.0	3150.0	3544.0	3938.0	4960.0
20	125		164.6	204.2	262.5	329.2	410.4	516.7	614.6	737.5	902.1	1310.4	1639.6	2050.0	2583.3	2912.5	3281.3	3691.7	4102.1	5166.7
20	130		171.2	212.3	273.0	342.3	426.8	537.3	639.2	767.0	938.2	1362.8	1705.2	2132.0	2686.7	3029.0	3412.5	3839.3	4266.2	5373.3
30	100		197.5	245.0	315.0	395.0	492.5	620.0	737.5	885.0	1082.5	1572.5	1967.5	2460.0	3100.0	3495.0	3937.5	4430.0	4922.5	6200.0
30	110		217.2	269.5	346.5	434.5	541.7	682.0	811.2	973.5	1190.7	1729.7	2164.2	2706.0	3410.0	3844.5	4331.3	4873.0	5414.7	6820.0
30	120		237.0	294.0	378.0	474.0	591.0	744.0	885.0	1062.0	1299.0	1887.0	2361.0	2952.0	3720.0	4194.0	4725.0	5316.0	5907.0	7440.0
30	125		246.9	306.2	393.8	493.7	615.6	775.0	921.9	1106.3	1353.1	1965.6	2459.4	3075.0	3875.0	4368.8	4921.9	5537.5	6153.1	7750.0
30	130		256.7	318.5	409.5	513.5	640.2	806.0	958.7	1150.5	1407.2	2044.2	2557.7	3198.0	4030.0	4543.5	5118.8	5759.0	6399.2	8060.0
50	100		329.2	408.3	525.0	658.3	820.8	1033.3	1229.2	1475.0	1804.2	2604.8	3279.2	4100.0	5166.7	5825.0	6562.5	7383.3	8204.2	10333.3
50	110		362.1	449.2	577.5	724.2	902.9	1136.7	1352.1	1622.5	1964.6	2829.9	3607.1	4510.0	5683.3	6407.5	7218.8	8121.7	9024.6	11366.7
50	120		395.0	490.0	630.0	790.0	985.0	1240.0	1475.0	1770.0	2165.0	3145.0	3935.0	4920.0	620					

Table B-2. Marston Soil Load Values for Asahi/America Pipe

Depth	Soil Type	Soil Wgt	Nominal Piping Diameter = 0.5 Inches							Nominal Piping Diameter = 0.75 Inches						
			Width of Trench in Feet							Width of Trench in Feet						
			0.5	0.75	1	2	3	4	5	0.5	0.75	1	2	3	4	5
3	granular w/o cohesion	100	7.6	10.1	11.8	15.8	16.2	17.1	17.4	9.4	12.6	14.7	19.6	20.1	21.2	21.6
3	sand and gravel	110	9.4	11.9	13.8	17.4	18.5	18.8	19.2	11.7	14.8	17.1	21.6	22.9	23.4	23.8
3	saturated top soil	120	11.1	14.2	15.8	19.7	20.4	21.2	21.7	13.7	17.6	19.6	24.5	25.3	26.3	27
3	dry clay	125	12.3	15.4	17.3	20.6	22.2	23	23	15.3	19.1	21.4	25.5	27.6	28.6	28.6
3	saturated clay	130	14.5	17.3	18.8	22.3	23.6	24.3	24.8	18	21.5	23.4	27.6	29.3	30.2	30.8
4	granular w/o cohesion	100	8.2	11.4	13.5	18.4	19.7	21.6	22.4	10.2	14.1	16.7	22.9	24.5	26.8	27.8
4	sand and gravel	110	10.1	13.6	15.9	21	21.7	24	25	12.6	16.8	19.8	26.1	27	29.8	31
4	saturated top soil	120	12	16	18.2	23.7	28.4	27.2	27.6	14.9	19.8	22.5	29.4	35.3	33.7	34.3
4	dry clay	125	14	17.9	20.6	26.3	29.6	29.6	30	17.4	22.2	25.5	32.7	36.8	36.7	37.3
4	saturated clay	130	16	19.9	23.1	28.2	30.8	31.5	32.1	19.9	24.7	28.7	35	38.2	39.1	39.8
5	granular w/o cohesion	100	8.4	11.8	14.8	22.4	24.7	25	27	10.4	14.7	18.4	27.8	30.6	31	33.5
5	sand and gravel	110	10.7	14.7	17.7	24.6	28.2	29	30.8	13.3	18.2	22	30.5	35	35.9	38.2
5	saturated top soil	120	12.6	17.2	20.9	27.6	30.8	31.6	34	15.7	21.3	26	34.3	38.2	39.2	42.1
5	dry clay	125	15.2	19.7	23	29.6	34.6	36.2	36.8	18.9	24.5	28.6	36.7	42.9	44.9	45.7
5	saturated clay	130	17.1	22.8	25.7	32.5	34.7	39.4	39.4	21.2	28.3	31.9	40.3	43	48.8	48.8
6	granular w/o cohesion	100	8.6	12.3	15.1	23	27.6	31.6	29	10.6	15.3	18.8	28.6	34.3	39.2	35.9
6	sand and gravel	110	10.9	15.2	18.8	27.5	31.5	34.8	32.6	13.5	18.9	23.4	34.1	39.1	43.1	40.4
6	saturated top soil	120	13	18.1	22.1	31.6	35.5	39.5	37.5	16.2	22.4	27.4	39.2	44.1	49	46.6
6	dry clay	125	15.6	21	24.7	34.6	39.5	41.1	41.1	19.4	26	30.6	42.9	49	51	51
6	saturated clay	130	18	23.7	29.1	37.7	43.6	44.5	44.9	22.3	29.5	36.1	46.7	54.1	55.2	55.7
8	granular w/o cohesion	100	8.6	12.6	16.5	27	31.6	36.9	39.5	10.6	15.6	20.4	33.5	39.2	45.7	49
8	sand and gravel	110	10.9	16	20.3	31.9	38	42	43.4	13.5	19.9	25.2	39.5	47.2	52.1	53.9
8	saturated top soil	120	13	19.6	24.1	36.3	42.7	47.4	49.4	16.2	24.3	29.9	45.1	52.9	58.8	61.3
8	dry clay	125	16	23.1	28	41.1	44.4	52.7	53.5	19.9	28.7	34.7	51	55.1	65.3	66.4
8	saturated clay	130	19	26	32.5	46.2	51.3	58.2	59.9	23.6	32.2	40.3	57.3	63.7	72.2	74.3
10	granular w/o cohesion	100	8.6	12.8	16.8	29.6	36.5	44.8	46.1	10.6	15.9	20.8	36.8	45.3	55.5	57.2
10	sand and gravel	110	10.9	16.3	21	35.5	43.4	49.2	52.5	13.5	20.2	26.1	44	53.9	61.1	65.1
10	saturated top soil	120	13	19.6	25.3	41.9	51	55.3	59.2	16.2	24.3	31.4	51.9	63.2	68.6	73.5
10	dry clay	125	16	23.5	30.4	46.1	54.3	59.2	65	19.9	29.1	37.8	57.2	67.4	73.5	80.6
10	saturated clay	130	19.3	28.6	34.2	51.3	59	65	72.7	23.9	35.4	42.5	63.7	73.3	80.7	90.2
15	granular w/o cohesion	100	8.6	12.8	17.1	32.3	44.4	51.3	51	10.6	15.9	21.2	40	55.1	63.7	63.3
15	sand and gravel	110	10.9	16.3	21.7	39.8	48.9	63.7	67	13.5	20.2	27	49.4	60.6	79.1	83.1
15	saturated top soil	120	13	19.6	26.1	47.4	64	72.7	79	16.2	24.3	32.3	58.8	79.4	90.2	98
15	dry clay	125	16	24.1	31.7	54.3	69.1	79	86.4	19.9	29.9	39.3	67.4	85.7	98	107.2
15	saturated clay	130	19.3	28.9	38.5	64.2	77	85.6	94.1	23.9	35.8	47.8	79.6	95.6	106.2	116.8
20	granular w/o cohesion	100	8.6	12.8	17.1	33.6	47.4	59.2	67.5	10.6	15.9	21.2	41.7	58.8	73.5	83.7
20	sand and gravel	110	10.9	16.3	21.7	42	58.7	71	81.5	13.5	20.2	27	52.1	72.8	88	101.1
20	saturated top soil	120	13	19.6	26.1	50.6	68.7	83.7	90.8	16.2	24.3	32.3	62.7	85.3	103.9	112.7
20	dry clay	125	16	24.1	32.1	60.9	79	92.2	102.9	19.9	29.9	39.8	75.5	98	114.3	127.6
20	saturated clay	130	19.3	28.9	38.5	68.5	91.1	102.7	115.5	23.9	35.8	47.8	84.9	113.1	127.4	143.3
25	granular w/o cohesion	100	8.6	12.8	17.1	34.2	49.4	61.9	74.1	10.6	15.9	21.2	42.5	61.3	76.8	91.9
25	sand and gravel	110	10.9	16.3	21.7	43.4	60.8	75.3	88.7	13.5	20.2	27	53.9	75.5	93.4	110
25	saturated top soil	120	13	19.6	26.1	51.3	72.3	88.5	104.7	16.2	24.3	32.3	63.7	89.7	109.8	129.9
25	dry clay	125	16	24.1	32.1	62.5	86.4	102	115.2	19.9	29.9	39.8	77.6	107.2	126.6	142.9
25	saturated clay	130	19.3	28.9	38.5	73.6	100.1	118.1	128.4	23.9	35.8	47.8	91.3	124.2	146.5	159.3
30	granular w/o cohesion	100	8.6	12.8	17.1	34.2	50.4	64.5	77.4	10.6	15.9	21.2	42.5	62.5	80	96
30	sand and gravel	110	10.9	16.3	21.7	43.4	63	79.7	94.1	13.5	20.2	27	53.9	78.2	98.8	116.8
30	saturated top soil	120	13	19.6	26.1	52.1	75.8	94.8	110.6	16.2	24.3	32.3	64.7	94.1	117.6	137.2
30	dry clay	125	16	24.1	32.1	63.4	91.3	108.6	125.5	19.9	29.9	39.8	78.6	113.3	134.8	155.7
30	saturated clay	130	19.3	28.9	38.5	75.3	102.7	128.4	145.5	23.9	35.8	47.8	93.4	127.4	159.3	180.5
40	granular w/o cohesion	100	8.6	12.8	17.1	34.2	51.3	67.1	82.3	10.6	15.9	21.2	42.5	63.7	83.3	102.1
40	sand and gravel	110	10.9	16.3	21.7	43.4	65.2	84	101.4	13.5	20.2	27	53.9	80.9	104.2	125.8
40	saturated top soil	120	13	19.6	26.1	52.1	78.2	101.1	120.5	16.2	24.3	32.3	64.7	97	125.4	149.5
40	dry clay	125	16	24.1	32.1	64.2	93.8	121.8	144	19.9	29.9	39.8	79.6	116.4	151.1	178.6
40	saturated clay	130	19.3	28.9	38.5	77	114.2	136.9	162.6	23.9	35.8	47.8	95.6	141.7	169.9	201.7
50	granular w/o cohesion	100	8.6	12.8	17.1	34.2	51.3	68.5	83.9	10.6	15.9	21.2	42.5	63.7	84.9	104.1
50	sand and gravel	110	10.9	16.3	21.7	43.4	65.2	86.9	105	13.5	20.2	27	53.9	80.9	107.8	130.3
50	saturated top soil	120	13	19.6	26.1	52.1	78.2	102.7	126.4	16.2	24.3	32.3	64.7	97	127.4	156.8
50	dry clay	125	16	24.1	32.1	64.2	96.3	126.7	152.2	19.9	29.9	39.8	79.6	119.4	157.2	188.9
50	saturated clay	130	19.3	28.9	38.5	77	115.5	147.2	171.2	23.9	35.8	47.8	95.6	143.3	182.6	212.3

Depth (of burial) is in feet; Soil Wgt (weight) is in lbs/ft³; values in the body of the table are in lbs of soil load per linear foot (lbs/linear ft).

Table B-2. Marston Soil Load Values for Asahi/America Pipe (continued)

Depth	Soil Type	Soil Wgt	Nominal Piping Diameter = 1 Inches							Nominal Piping Diameter = 1.25 Inches						
			Width of Trench in Feet							Width of Trench in Feet						
			0.5	0.75	1	2	3	4	5	0.5	0.75	1	2	3	4	5
3	granular w/o cohesion	100	12.1	16.1	18.9	25.2	25.8	27.3	27.8	15.1	20.2	23.7	31.6	32.4	34.2	34.9
3	sand and gravel	110	15	19.1	21.9	27.7	29.5	30	30.6	18.8	23.9	27.5	34.8	36.9	37.7	38.4
3	saturated top soil	120	17.6	22.7	25.2	31.5	32.5	33.8	34.7	22.1	28.4	31.6	39.5	40.8	42.3	43.5
3	dry clay	125	19.7	24.6	27.6	32.8	35.4	36.8	36.8	24.7	30.9	34.6	41.1	44.4	46.1	46.1
3	saturated clay	130	23.2	27.6	30	35.5	37.7	38.8	39.6	29.1	34.7	37.7	44.5	47.2	48.6	49.6
4	granular w/o cohesion	100	13.1	18.1	21.5	29.4	31.5	34.4	35.7	16.5	22.7	27	36.9	39.5	43.2	44.8
4	sand and gravel	110	16.2	21.7	25.4	33.5	34.7	38.3	39.8	20.3	27.2	31.9	42	43.5	48.1	50
4	saturated top soil	120	19.2	25.5	29	37.8	45.4	43.3	44.1	24.1	32	36.3	47.4	56.9	54.4	55.3
4	dry clay	125	22.3	28.5	32.8	42	47.3	47.3	47.9	28	35.8	41.1	52.7	59.3	59.3	60.1
4	saturated clay	130	25.6	31.7	36.9	45	49.1	50.2	51.2	32.1	39.8	46.2	56.5	61.6	63	64.2
5	granular w/o cohesion	100	13.4	18.9	23.6	35.7	39.4	39.9	43.1	16.8	23.7	29.6	44.8	49.4	50	54
5	sand and gravel	110	17	23.4	28.3	39.3	45	46.2	49.1	21.4	29.3	35.5	49.2	56.5	57.9	61.6
5	saturated top soil	120	20.2	27.4	33.4	44.1	49.1	50.4	54.2	25.3	34.4	41.9	55.3	61.6	63.2	67.9
5	dry clay	125	24.3	31.5	36.8	47.3	55.1	57.8	58.7	30.4	39.5	46.1	59.3	69.1	72.4	73.7
5	saturated clay	130	27.3	36.3	41	51.9	55.3	62.8	62.8	34.2	45.6	51.4	65	69.3	78.7	78.7
6	granular w/o cohesion	100	13.7	19.7	24.2	36.8	44.1	50.4	46.2	17.1	24.7	30.3	46.1	55.3	63.2	57.9
6	sand and gravel	110	17.3	24.3	30	43.9	50.2	55.4	52	21.7	30.4	37.7	55	63	69.5	65.2
6	saturated top soil	120	20.8	28.8	35.3	50.4	56.7	63	59.9	26.1	36.1	44.2	63.2	71.1	79	75.1
6	dry clay	125	24.9	33.5	39.4	55.1	63	65.6	65.6	31.3	42	49.4	69.1	79	82.3	82.3
6	saturated clay	130	28.7	37.9	46.4	60.1	69.6	71	71.7	35.9	47.5	58.2	75.3	87.3	89	89.9
8	granular w/o cohesion	100	13.7	20.1	26.3	43.1	50.4	58.8	63	17.1	25.2	32.9	54	63.2	73.7	79
8	sand and gravel	110	17.3	25.6	32.3	50.8	60.6	67	69.3	21.7	32	40.6	63.7	76	84	86.9
8	saturated top soil	120	20.8	31.2	38.4	58	68	75.6	78.8	26.1	39.1	48.2	72.7	85.3	94.8	98.8
8	dry clay	125	25.6	36.9	44.6	65.6	70.9	84	85.3	32.1	46.3	56	82.3	88.9	105.3	107
8	saturated clay	130	30.4	41.5	51.9	73.7	81.9	92.8	95.6	38.1	52	65	92.4	102.7	116.4	119.8
10	granular w/o cohesion	100	13.7	20.5	26.8	47.3	58.3	71.4	73.5	17.1	25.7	33.6	59.3	73.1	89.5	92.2
10	sand and gravel	110	17.3	26	33.5	56.6	69.3	78.5	83.7	21.7	32.6	42	71	86.9	98.5	105
10	saturated top soil	120	20.8	31.2	40.3	66.8	81.3	88.2	94.5	26.1	39.1	50.6	83.7	101.9	110.6	118.5
10	dry clay	125	25.6	37.4	48.6	73.5	86.6	94.5	103.7	32.1	46.9	60.9	92.2	108.6	118.5	130
10	saturated clay	130	30.7	45.6	54.6	81.9	94.2	103.7	116	38.5	57.1	68.5	102.7	118.1	130.1	145.5
15	granular w/o cohesion	100	13.7	20.5	27.3	51.5	70.9	81.9	81.4	17.1	25.7	34.2	64.5	88.9	102.7	102
15	sand and gravel	110	17.3	26	34.7	63.5	78	101.6	106.8	21.7	32.6	43.5	79.7	97.8	127.5	134
15	saturated top soil	120	20.8	31.2	41.6	75.6	102.1	115.9	126	26.1	39.1	52.1	94.8	128	145.4	158
15	dry clay	125	25.6	38.4	50.5	86.6	110.3	126	137.8	32.1	48.1	63.4	108.6	138.3	158	172.8
15	saturated clay	130	30.7	46.1	61.4	102.4	122.9	136.5	150.2	38.5	57.8	77	128.4	154.1	171.2	188.3
20	granular w/o cohesion	100	13.7	20.5	27.3	53.6	75.6	94.5	107.6	17.1	25.7	34.2	67.2	94.8	118.5	135
20	sand and gravel	110	17.3	26	34.7	67	93.6	113.2	129.9	21.7	32.6	43.5	84	117.3	141.9	162.9
20	saturated top soil	120	20.8	31.2	41.6	80.6	109.6	133.6	144.9	26.1	39.1	52.1	101.1	137.5	167.5	181.7
20	dry clay	125	25.6	38.4	51.2	97.1	126	147	164.1	32.1	48.1	64.2	121.8	158	184.3	205.7
20	saturated clay	130	30.7	46.1	61.4	109.2	145.4	163.8	184.3	38.5	57.8	77	136.9	182.3	205.4	231.1
25	granular w/o cohesion	100	13.7	20.5	27.3	54.6	78.8	98.7	118.1	17.1	25.7	34.2	68.5	98.8	123.8	148.1
25	sand and gravel	110	17.3	26	34.7	69.3	97	120.1	141.5	21.7	32.6	43.5	86.9	121.7	150.6	177.4
25	saturated top soil	120	20.8	31.2	41.6	81.9	115.3	141.1	167	26.1	39.1	52.1	102.7	144.6	177	209.4
25	dry clay	125	25.6	38.4	51.2	99.8	137.8	162.8	183.8	32.1	48.1	64.2	125.1	172.8	204.1	230.4
25	saturated clay	130	30.7	46.1	61.4	117.4	159.7	188.4	204.8	38.5	57.8	77	147.2	200.3	236.2	256.8
30	granular w/o cohesion	100	13.7	20.5	27.3	54.6	80.3	102.9	123.4	17.1	25.7	34.2	68.5	100.7	129	154.7
30	sand and gravel	110	17.3	26	34.7	69.3	100.5	127.1	150.2	21.7	32.6	43.5	86.9	126	159.3	188.3
30	saturated top soil	120	20.8	31.2	41.6	83.2	121	151.2	176.4	26.1	39.1	52.1	104.3	151.7	189.6	221.2
30	dry clay	125	25.6	38.4	51.2	101.1	145.7	173.3	200.2	32.1	48.1	64.2	126.7	182.7	217.3	251
30	saturated clay	130	30.7	46.1	61.4	120.1	163.8	204.8	232.1	38.5	57.8	77	150.6	205.4	256.8	291
40	granular w/o cohesion	100	13.7	20.5	27.3	54.6	81.9	107.1	131.3	17.1	25.7	34.2	68.5	102.7	134.3	164.6
40	sand and gravel	110	17.3	26	34.7	69.3	104	134	161.7	21.7	32.6	43.5	86.9	130.4	168	202.8
40	saturated top soil	120	20.8	31.2	41.6	83.2	124.7	161.3	192.2	26.1	39.1	52.1	104.3	156.4	202.2	241
40	dry clay	125	25.6	38.4	51.2	102.4	149.6	194.3	229.7	32.1	48.1	64.2	128.4	187.6	243.6	288
40	saturated clay	130	30.7	46.1	61.4	122.9	182.2	218.4	259.4	38.5	57.8	77	154.1	228.5	273.9	325.2
50	granular w/o cohesion	100	13.7	20.5	27.3	54.6	81.9	109.2	133.9	17.1	25.7	34.2	68.5	102.7	136.9	167.9
50	sand and gravel	110	17.3	26	34.7	69.3	104	138.6	167.5	21.7	32.6	43.5	86.9	130.4	173.8	210
50	saturated top soil	120	20.8	31.2	41.6	83.2	124.7	163.8	201.6	26.1	39.1	52.1	104.3	156.4	205.4	252.8
50	dry clay	125	25.6	38.4	51.2	102.4	153.6	202.1	242.8	32.1	48.1	64.2	128.4	192.6	253.5	304.5
50	saturated clay	130	30.7	46.1	61.4	122.9	184.3	234.8	273	38.5	57.8	77	154.1	231.1	294.4	342.3

Depth (of burial) is in feet; Soil Wgt (weight) is in lbs/ft³; values in the body of the table are in lbs of soil load per linear foot (lbs/linear ft).

Table B-2. Marston Soil Load Values for Asahi/America Pipe (continued)

Depth	Soil Type	Soil Wgt	Nominal Piping Diameter = 1.5 Inches							Nominal Piping Diameter = 2 Inches					
			Width of Trench in Feet							Width of Trench in Feet					
			0.5	0.75	1	2	3	4	5	0.75	1	2	3	4	5
3	granular w/o cohesion	100	18.9	25.2	29.6	39.4	40.4	42.7	43.5	31.8	37.2	49.6	50.8	53.7	54.8
3	sand and gravel	110	23.5	29.8	34.3	43.3	46	47	47.9	37.5	43.2	54.6	58	59.1	60.2
3	saturated top soil	120	27.6	35.5	39.4	49.3	50.8	52.8	54.2	44.6	49.6	62	64	66.5	68.2
3	dry clay	125	30.8	38.5	43.1	51.3	55.4	57.5	57.5	48.4	54.3	64.6	69.8	72.3	72.3
3	saturated clay	130	36.3	43.2	47	55.5	58.9	60.6	61.9	54.4	59.1	69.9	74.2	76.3	77.9
4	granular w/o cohesion	100	20.5	28.3	33.7	46	49.3	53.8	55.8	35.7	42.4	57.9	62	67.8	70.3
4	sand and gravel	110	25.3	33.9	39.7	52.4	54.2	60	62.3	42.6	50	65.9	68.2	75.5	78.4
4	saturated top soil	120	30	39.9	45.3	59.1	70.9	67.8	69	50.2	57	74.4	89.3	85.3	86.8
4	dry clay	125	34.9	44.6	51.3	65.7	73.9	73.9	74.9	56.2	64.6	82.7	93	93	94.3
4	saturated clay	130	40	49.6	57.6	70.4	76.8	78.5	80	62.5	72.5	88.7	96.7	98.9	100.8
5	granular w/o cohesion	100	20.9	29.6	36.9	55.8	61.6	62.4	67.3	37.2	46.5	70.3	77.5	78.5	84.7
5	sand and gravel	110	26.6	36.6	44.2	61.4	70.4	72.2	76.7	46	55.7	77.3	88.7	90.9	96.6
5	saturated top soil	120	31.5	42.8	52.2	69	76.8	78.8	84.7	53.9	65.7	86.8	96.7	99.2	106.6
5	dry clay	125	38	49.3	57.5	73.9	86.2	90.3	91.8	62	72.3	93	108.5	113.7	115.6
5	saturated clay	130	42.7	56.8	64	81.1	86.4	98.2	98.2	71.5	80.6	102.1	108.8	123.6	123.6
6	granular w/o cohesion	100	21.3	30.8	37.8	57.5	69	78.8	72.2	38.8	47.5	72.3	86.8	99.2	90.9
6	sand and gravel	110	27.1	37.9	47	68.6	78.6	86.7	81.3	47.7	59.1	86.4	98.9	109.1	102.3
6	saturated top soil	120	32.5	45.1	55.2	78.8	88.7	98.5	93.6	56.7	69.4	99.2	111.6	124	117.8
6	dry clay	125	39	52.3	61.6	86.2	98.5	102.6	102.6	65.9	77.5	108.5	124	129.2	129.2
6	saturated clay	130	44.8	59.2	72.6	93.9	108.8	111	112	74.6	91.3	118.2	137	139.7	141.1
8	granular w/o cohesion	100	21.3	31.4	41	67.3	78.8	91.9	98.5	39.5	51.7	84.7	99.2	115.7	124
8	sand and gravel	110	27.1	40	50.6	79.5	94.8	104.7	108.4	50.3	63.7	100	119.4	131.9	136.4
8	saturated top soil	120	32.5	48.8	60.1	90.6	106.4	118.2	123.1	61.4	75.6	114.1	133.9	148.8	155
8	dry clay	125	40	57.7	69.8	102.6	110.8	131.3	133.4	72.7	87.8	129.2	139.5	165.3	167.9
8	saturated clay	130	47.5	64.8	81.1	115.2	128.1	145.1	149.4	81.6	102.1	145.1	161.2	182.7	188.1
10	granular w/o cohesion	100	21.3	32	41.9	73.9	91.1	111.6	114.9	40.3	52.7	93	114.7	140.5	144.7
10	sand and gravel	110	27.1	40.6	52.4	88.5	108.4	122.8	130.9	51.2	65.9	111.4	136.4	154.6	164.8
10	saturated top soil	120	32.5	48.8	63	104.4	127.1	137.9	147.8	61.4	79.4	131.4	160	173.6	186
10	dry clay	125	40	58.5	75.9	114.9	135.4	147.8	162.1	73.6	95.6	144.7	170.5	186	204.1
10	saturated clay	130	48	71.2	85.4	128.1	147.3	162.2	181.4	89.7	107.5	161.2	185.4	204.2	228.4
15	granular w/o cohesion	100	21.3	32	42.7	80.4	110.8	128.1	127.2	40.3	53.7	101.3	139.5	161.2	160.2
15	sand and gravel	110	27.1	40.6	54.2	99.3	121.9	158.9	167	51.2	68.2	125	153.5	200.1	210.3
15	saturated top soil	120	32.5	48.8	65	118.2	159.6	181.2	197	61.4	81.8	148.8	200.9	228.2	248
15	dry clay	125	40	60	79	135.4	172.4	197	215.5	75.6	99.5	170.5	217	248	271.3
15	saturated clay	130	48	72	96	160.1	192.1	213.4	234.8	90.7	120.9	201.5	241.8	268.7	295.5
20	granular w/o cohesion	100	21.3	32	42.7	83.7	118.2	147.8	168.3	40.3	53.7	105.4	148.8	186	211.8
20	sand and gravel	110	27.1	40.6	54.2	104.7	146.3	177	203.2	51.2	68.2	131.9	184.1	222.8	255.8
20	saturated top soil	120	32.5	48.8	65	126.1	171.4	208.8	226.6	61.4	81.8	158.7	215.8	262.9	285.2
20	dry clay	125	40	60	80	151.9	197	229.8	256.5	75.6	100.8	191.2	248	289.3	322.9
20	saturated clay	130	48	72	96	170.7	227.3	256.1	288.1	90.7	120.9	214.9	286.1	322.4	362.7
25	granular w/o cohesion	100	21.3	32	42.7	85.4	123.1	154.3	184.7	40.3	53.7	107.5	155	194.3	232.5
25	sand and gravel	110	27.1	40.6	54.2	108.4	151.7	187.8	221.2	51.2	68.2	136.4	191	236.4	278.5
25	saturated top soil	120	32.5	48.8	65	128.1	180.3	220.6	261	61.4	81.8	161.2	226.9	277.8	328.6
25	dry clay	125	40	60	80	156	215.5	254.5	287.3	75.6	100.8	196.3	271.3	320.3	361.7
25	saturated clay	130	48	72	96	183.5	249.7	294.5	320.1	90.7	120.9	231.1	314.3	370.8	403
30	granular w/o cohesion	100	21.3	32	42.7	85.4	125.6	160.9	192.9	40.3	53.7	107.5	158.1	202.5	242.8
30	sand and gravel	110	27.1	40.6	54.2	108.4	157.1	198.6	234.8	51.2	68.2	136.4	197.8	250.1	295.5
30	saturated top soil	120	32.5	48.8	65	130	189.1	236.4	275.8	61.4	81.8	163.7	238.1	297.6	347.2
30	dry clay	125	40	60	80	158	227.8	270.9	312.9	75.6	100.8	198.9	286.8	341	394
30	saturated clay	130	48	72	96	187.8	256.1	320.1	362.8	90.7	120.9	236.4	322.4	403	456.7
40	granular w/o cohesion	100	21.3	32	42.7	85.4	128.1	167.5	205.2	40.3	53.7	107.5	161.2	210.8	258.3
40	sand and gravel	110	27.1	40.6	54.2	108.4	162.5	209.5	252.8	51.2	68.2	136.4	204.6	263.7	318.3
40	saturated top soil	120	32.5	48.8	65	130	195	252.2	300.4	61.4	81.8	163.7	245.5	317.4	378.2
40	dry clay	125	40	60	80	160.1	233.9	303.7	359.1	75.6	100.8	201.5	294.5	382.3	452.1
40	saturated clay	130	48	72	96	192.1	284.9	341.5	405.5	90.7	120.9	241.8	358.7	429.9	510.5
50	granular w/o cohesion	100	21.3	32	42.7	85.4	128.1	170.7	209.3	40.3	53.7	107.5	161.2	214.9	263.5
50	sand and gravel	110	27.1	40.6	54.2	108.4	162.5	216.7	261.8	51.2	68.2	136.4	204.6	272.8	329.6
50	saturated top soil	120	32.5	48.8	65	130	195	256.1	315.2	61.4	81.8	163.7	245.5	322.4	396.8
50	dry clay	125	40	60	80	160.1	240.1	316	379.6	75.6	100.8	201.5	302.3	397.8	477.9
50	saturated clay	130	48	72	96	192.1	288.1	367.1	426.8	90.7	120.9	241.8	362.7	462.1	537.3

Depth (of burial) is in feet; Soil Wgt (weight) is in lbs/ft³; values in the body of the table are in lbs of soil load per linear foot (lbs/linear ft).

Table B-2. Marston Soil Load Values for Asahi/America Pipe (continued)

Depth	Soil Type	Soil Wgt	Nominal Piping Diameter = 2.5 Inches					Nominal Piping Diameter = 3 Inches						
			Width of Trench in Feet					Width of Trench in Feet						
			0.75	1	2	3	4	5	0.75	1	2	3	4	5
3	granular w/o cohesion	100	37.8	44.2	59	60.5	63.9	65.1	45.4	53.1	70.8	72.6	76.7	78.2
3	sand and gravel	110	44.6	51.4	4.9	69	70.3	71.7	53.5	61.7	77.9	82.7	84.4	86
3	saturated top soil	120	53.1	59	73.8	76.1	79.1	81.1	63.7	70.8	88.5	91.3	94.9	97.4
3	dry clay	125	57.6	64.5	76.8	83	86	86	69.1	77.4	92.2	99.6	103.3	103.3
3	saturated clay	130	64.7	70.3	83.1	88.2	90.8	92.7	77.7	84.4	99.7	105.8	108.9	111.2
4	granular w/o cohesion	100	42.4	50.4	68.8	73.7	80.6	83.6	50.9	60.5	82.6	88.5	96.8	100.3
4	sand and gravel	110	50.7	59.5	78.4	81.1	89.8	93.3	60.8	71.4	94.1	97.4	107.7	112
4	saturated top soil	120	59.7	67.9	88.5	106.2	101.5	103.3	71.7	81.4	106.2	127.4	121.8	123.9
4	dry clay	125	66.8	76.8	98.3	110.6	110.6	112.2	80.2	92.2	118	132.8	132.8	134.6
4	saturated clay	130	74.3	86.3	105.5	115.1	117.6	119.8	89.2	103.5	126.6	138.1	141.1	143.8
5	granular w/o cohesion	100	44.2	55.3	83.6	92.2	93.4	100.8	53.1	66.4	100.3	110.6	112.1	121
5	sand and gravel	110	54.8	66.3	91.9	105.5	108.2	114.9	65.7	79.5	110.3	126.6	129.8	137.9
5	saturated top soil	120	64.2	78.2	103.3	115.1	118	126.9	77	93.8	123.9	138.1	141.6	152.2
5	dry clay	125	73.7	86	110.6	129.1	135.2	137.5	88.5	103.3	132.8	154.9	162.3	165
5	saturated clay	130	85.1	95.9	121.4	129.4	147	147	102.1	115.1	145.7	155.3	176.4	176.4
6	granular w/o cohesion	100	46.1	56.5	86	103.3	118	108.2	55.3	67.9	103.3	123.9	141.6	129.8
6	sand and gravel	110	56.8	70.3	102.8	117.6	129.8	121.7	68.1	84.4	123.3	141.2	155.8	146
6	saturated top soil	120	67.5	82.6	118	132.8	147.5	140.1	81	99.1	141.6	159.3	177	168.2
6	dry clay	125	78.4	92.2	129.1	147.5	153.6	153.6	94	110.6	154.9	177	184.4	184.4
6	saturated clay	130	88.7	108.7	140.6	163	166.2	167.8	106.4	130.4	168.7	195.6	199.4	201.3
8	granular w/o cohesion	100	47	61.5	100.8	118	137.7	147.5	56.4	73.8	121	141.6	165.2	177
8	sand and gravel	110	59.8	75.7	119	142	156.8	162.3	71.8	90.9	142.8	170.4	188.2	194.7
8	saturated top soil	120	73	90	135.7	159.3	177	184.4	87.6	108	162.8	191.2	212.4	221.3
8	dry clay	125	86.4	104.5	153.6	165.9	196.7	199.7	103.7	125.4	184.4	199.1	236	239.7
8	saturated clay	130	97.1	121.4	172.6	191.8	217.3	223.7	116.5	145.7	207.1	230.1	260.8	268.5
10	granular w/o cohesion	100	47.9	62.7	110.6	136.4	167.2	172.1	57.5	75.2	132.8	163.7	200.6	206.5
10	sand and gravel	110	60.8	78.4	132.5	162.3	183.9	196.1	73	94.1	159	194.7	220.7	235.3
10	saturated top soil	120	73	94.4	156.4	190.3	206.5	221.3	87.6	113.3	187.6	228.3	247.8	265.5
10	dry clay	125	87.6	113.7	172.1	202.8	221.3	242.8	105.1	136.4	206.5	243.4	265.5	291.3
10	saturated clay	130	106.7	127.8	191.8	220.5	242.9	271.6	128	153.4	230.1	264.6	291.5	326
15	granular w/o cohesion	100	47.9	63.9	120.5	165.9	191.8	190.5	57.5	76.7	144.6	199.1	230.1	228.6
15	sand and gravel	110	60.8	81.1	148.7	182.5	238	250.1	73	97.4	178.5	219	285.6	300.2
15	saturated top soil	120	73	97.4	177	239	271.4	295	87.6	116.8	212.4	286.7	325.7	354
15	dry clay	125	89.9	118.3	202.8	258.1	295	322.7	107.9	142	243.4	309.8	354	387.2
15	saturated clay	130	107.9	143.8	239.7	287.6	319.6	351.5	129.4	172.6	287.6	345.2	383.5	421.9
20	granular w/o cohesion	100	47.9	63.9	125.4	177	221.3	252	57.5	76.7	150.5	212.4	265.5	302.4
20	sand and gravel	110	60.8	81.1	156.8	219	265	304.2	73	97.4	188.2	262.8	318	365.1
20	saturated top soil	120	73	97.4	188.8	256.7	312.7	339.3	87.6	116.8	226.6	308	375.2	407.1
20	dry clay	125	89.9	119.8	227.4	295	344.2	384.1	107.9	143.8	272.9	354	413	460.9
20	saturated clay	130	107.9	143.8	255.7	340.4	383.5	431.4	129.4	172.6	306.8	408.4	460.2	517.7
25	granular w/o cohesion	100	47.9	63.9	127.8	184.4	231.1	276.6	57.5	76.7	153.4	221.3	277.3	331.9
25	sand and gravel	110	60.8	81.1	162.3	227.2	281.2	331.3	73	97.4	194.7	272.6	337.5	397.5
25	saturated top soil	120	73	97.4	191.8	269.9	330.4	390.9	87.6	116.8	230.1	323.9	396.5	469.1
25	dry clay	125	89.9	119.8	233.5	322.7	381	430.2	107.9	143.8	280.3	387.2	457.3	516.3
25	saturated clay	130	107.9	143.8	274.8	373.9	441	479.4	129.4	172.6	329.8	448.7	529.2	575.3
30	granular w/o cohesion	100	47.9	63.9	127.8	188.1	240.9	288.9	57.5	76.7	153.4	225.7	289.1	346.6
30	sand and gravel	110	60.8	81.1	162.3	235.3	297.5	351.5	73	97.4	194.7	282.3	357	421.9
30	saturated top soil	120	73	97.4	194.7	283.2	354	413	87.6	116.8	233.6	339.8	424.8	495.6
30	dry clay	125	89.9	119.8	236.6	341.1	405.6	468.6	107.9	143.8	283.9	409.3	486.8	562.3
30	saturated clay	130	107.9	143.8	281.2	383.5	479.4	543.3	129.4	172.6	337.5	460.2	575.3	652
40	granular w/o cohesion	100	47.9	63.9	127.8	191.8	250.8	307.3	57.5	76.7	153.4	230.1	300.9	368.8
40	sand and gravel	110	60.8	81.1	162.3	243.4	313.7	378.6	73	97.4	194.7	292.1	376.4	454.3
40	saturated top soil	120	73	97.4	194.7	292.1	377.6	449.9	87.6	116.8	233.6	350.5	453.1	539.9
40	dry clay	125	89.9	119.8	239.7	350.3	454.8	537.8	107.9	143.8	287.6	420.4	545.8	645.3
40	saturated clay	130	107.9	143.8	287.6	426.6	511.3	607.2	129.4	172.6	345.2	512	613.6	728.7
50	granular w/o cohesion	100	47.9	63.9	127.8	191.8	255.7	313.4	57.5	76.7	153.4	230.1	306.8	376.1
50	sand and gravel	110	60.8	81.1	162.3	243.4	324.5	392.1	73	97.4	194.7	292.1	389.4	470.5
50	saturated top soil	120	73	97.4	194.7	292.1	383.5	472	87.6	116.8	233.6	350.5	460.2	566.4
50	dry clay	125	89.9	119.8	239.7	359.5	473.2	568.5	107.9	143.8	287.6	431.4	567.9	682.2
50	saturated clay	130	107.9	143.8	287.6	431.4	549.7	639.2	129.4	172.6	345.2	517.7	659.6	767

Depth (of burial) is in feet; Soil Wgt (weight) is in lbs/ft³; values in the body of the table are in lbs of soil load per linear foot (lbs/linear ft).

Table B-2. Marston Soil Load Values for Asahi/America Pipe (continued)

Depth	Soil Type	Soil Wgt	Nominal Piping Diameter = 4 Inches					Nominal Piping Diameter = 6 Inches						
			Width of Trench in Feet					Width of Trench in Feet						
			0.75	1	2	3	4	5	1	2	3	4	5	
3	granular w/o cohesion	100	55.5	64.9	86.6	88.8		93.8	95.6	94.4	125.8	128.9	136.3	138.9
3	sand and gravel	110	65.5	75.4	95.3		101.2	103.2	105.2	109.6	138.4	147.0	149.9	152.8
3	saturated top soil	120	77.9	86.6	108.3	111.7	116.0	119.1	125.8	157.3	162.3	168.6	173.0	
3	dry clay	125	84.6	94.7	112.8	121.8	126.3	126.3	137.6	163.8	176.9	183.5	183.5	
3	saturated clay	130	95.0	103.2	122.0	129.5	133.2	136.0	149.9	177.2	188.1	193.5	197.6	
4	granular w/o cohesion	100	62.2	74.0	101.0	108.3	118.4	122.7	107.5	146.8	157.3	171.9	178.2	
4	sand and gravel	110	74.4	87.3	115.1	119.1	131.8	136.9	126.8	167.2	173.0	191.4	198.9	
4	saturated top soil	120	87.7	99.6	129.9	155.9	149.0	151.6	144.7	188.7	226.4	216.4	220.2	
4	dry clay	125	98.1	112.8	144.3	162.4		162.4	163.8	209.7	235.9	235.9	239.2	
4	saturated clay	130	109.1	126.7	154.8	168.9		172.6	184.0	224.9	245.3	250.8	255.5	
5	granular w/o cohesion	100	64.9	81.2	122.7	135.3	137.1	147.9	117.9	178.2	196.6	199.2	214.9	
5	sand and gravel	110	80.4	97.2	135.0	154.8	158.8	168.7	141.3	196.0	224.9	230.6	245.0	
5	saturated top soil	120	94.2	114.7	151.6	168.9		173.2	166.7	220.2	245.3	251.6	270.5	
5	dry clay	125	108.3	126.3	162.4	189.4		198.5	183.5	235.9	275.2	288.3	293.2	
5	saturated clay	130	124.9	140.7	178.3	190		215.8	204.4	258.9	276.0	313.5	313.5	
6	granular w/o cohesion	100	67.7	83.0	126.3	151.6	173.2	158.8	120.6	183.5	220.2	251.6	230.6	
6	sand and gravel	110	83.4	103.2	150.8	172.7		190.5	149.9	219.1	250.8	276.8	259.5	
6	saturated top soil	120	99.0	121.2	173.2	194.9		216.5	176.1	251.6	283.1	314.5	298.8	
6	dry clay	125	115.0	135.3	189.4	216.5		225.5	196.6	275.2	314.5	327.6	327.6	
6	saturated clay	130	130.2	159.5	206.4	239.2		243.9	231.7	299.8	347.5	354.3	357.7	
8	granular w/o cohesion	100	69.0	90.2	147.9	173.2		202.1	131.0	214.9	251.6	293.5	314.5	
8	sand and gravel	110	87.8	111.1	174.6	208.4		230.2	161.4	253.7	302.7	334.4	346.0	
8	saturated top soil	120	107.2	132.1	199.2	233.8		259.8	191.8	289.3	339.7	377.4	393.1	
8	dry clay	125	126.9	153.4	225.5	243.6		288.7	222.8	327.6	353.8	419.3	425.9	
8	saturated clay	130	142.5	178.3	253.3	281.5		319.0	258.9	368.0	408.8	463.4	477.0	
10	granular w/o cohesion	100	70.4	92.0	162.4	200.3		245.4	133.7	235.9	290.9	356.4	366.9	
10	sand and gravel	110	89.3	115.1	194.5	238.2		269.9	167.2	282.5	346.0	392.1	418.0	
10	saturated top soil	120	107.2	138.6	229.5	279.3		303.1	201.3	333.4	405.7	440.3	471.8	
10	dry clay	125	128.5	166.9	252.6	297.7		324.8	242.4	366.9	432.4	471.8	517.6	
10	saturated clay	130	156.6	187.6	281.5	323.7		356.5	272.6	408.9	470.2	517.9	579.2	
15	granular w/o cohesion	100	70.4	93.8	176.8	243.6		281.5	136.3	256.8	353.8	408.9	406.2	
15	sand and gravel	110	89.3	119.1	218.3	267.9		349.3	173.0	317.1	389.2	507.4	533.3	
15	saturated top soil	120	107.2	142.9	259.8	350.7		398.4	207.6	377.4	509.5	578.7	629.0	
15	dry clay	125	131.9	173.7	297.7	378.9		433.0	252.3	432.4	550.4	629.0	688.0	
15	saturated clay	130	158.3	211.1	351.8	422.2		469.1	306.6	511.1	613.3	681.4	749.6	
20	granular w/o cohesion	100	70.4	93.8	184.0	259.8		324.8	136.3	267.3	377.4	471.8	537.3	
20	sand and gravel	110	89.3	119.1	230.2	321.5		389.0	173.0	334.4	467.0	565.1	648.7	
20	saturated top soil	120	107.2	142.9	277.1	376.7		459.0	207.6	402.6	547.2	666.7	723.4	
20	dry clay	125	131.9	175.9	333.8	433		505.2	255.5	484.9	629.0	733.8	819.0	
20	saturated clay	130	158.3	211.1	375.3	499.6		562.9	306.6	545.1	725.7	817.7	919.9	
25	granular w/o cohesion	100	70.4	93.8	187.6	270.6		339.2	136.3	272.6	393.1	492.7	589.7	
25	sand and gravel	110	89.3	119.1	238.2	333.4		412.8	173.0	346.0	484.3	599.6	706.3	
25	saturated top soil	120	107.2	142.9	281.5	396.2		485.0	207.6	408.9	575.5	704.5	833.4	
25	dry clay	125	131.9	175.9	342.8	473.6		559.3	255.5	498.0	688.0	812.5	917.3	
25	saturated clay	130	158.3	211.1	403.4	548.8		647.3	306.6	586.0	797.3	940.4	1022.1	
30	granular w/o cohesion	100	70.4	93.8	187.6	276.0		353.6	136.3	272.6	401.0	513.7	615.9	
30	sand and gravel	110	89.3	119.1	238.2	345.3		436.6	173.0	346.0	501.6	634.2	749.6	
30	saturated top soil	120	107.2	142.9	285.8	415.7		519.6	207.6	415.1	603.8	754.8	880.6	
30	dry clay	125	131.9	175.9	347.3	500.7		595.4	255.5	504.5	727.3	864.9	999.2	
30	saturated clay	130	158.3	211.1	412.8	562.9		703.6	306.6	599.6	817.7	1022.1	1158.4	
40	granular w/o cohesion	100	70.4	93.8	187.6	281.5		368.1	136.3	272.6	408.8	534.7	655.2	
40	sand and gravel	110	89.3	119.1	238.2	357.2		460.4	173.0	346.0	518.9	668.8	807.2	
40	saturated top soil	120	107.2	142.9	285.8	428.7		554.2	207.6	415.1	622.7	805.1	959.2	
40	dry clay	125	131.9	175.9	351.8	514.2		667.5	255.5	511.1	746.9	969.7	1146.6	
40	saturated clay	130	158.3	211.1	422.2	626.2		750.5	306.6	613.3	909.7	1090.3	1294.7	
50	granular w/o cohesion	100	70.4	93.8	187.6	281.5		375.3	136.3	272.6	408.8	545.1	668.3	
50	sand and gravel	110	89.3	119.1	238.2	357.2		476.3	173.0	346.0	518.9	691.9	836.0	
50	saturated top soil	120	107.2	142.9	285.8	428.7		562.9	207.6	415.1	622.7	817.7	1006.4	
50	dry clay	125	131.9	175.9	351.8	527.7		694.6	255.5	511.1	766.6	1009.0	1212.1	
50	saturated clay	130	158.3	211.1	422.2	633.3		806.8	306.6	613.3	919.9	1172.0	1362.8	

B

Depth (of burial) is in feet; Soil Wgt (weight) is in lbs/ft³; values in the body of the table are in lbs of soil load per linear foot (lbs/linear ft).

Table B-2. Marston Soil Load Values for Asahi/America Pipe (continued)

Depth	Soil Type	Soil Wgt	Nominal Piping Diameter = 8 Inches					Nominal Piping Diameter = 10 Inches				
			Width of Trench in Feet					Width of Trench in Feet				
			1	2	3	4	5	2	3	4	5	
3	granular w/o cohesion	100	118.1	157.4	161.3	170.5	173.8	196.8	201.7	213.2	217.3	
3	sand and gravel	110	137.1	173.1	184.0	187.6	191.2	216.5	230.0	234.5	239.0	
3	saturated top soil	120	157.4	196.8	203.0	210.9	216.4	246.0	253.9	263.7	270.6	
3	dry clay	125	172.2	204.9	221.3	229.5	229.5	256.3	276.8	287.0	287.0	
3	saturated clay	130	187.6	221.7	235.3	242.1	247.2	277.2	294.2	302.7	309.1	
4	granular w/o cohesion	100	134.4	183.6	196.8	215.1	223.0	229.6	246.0	269.0	278.8	
4	sand and gravel	110	158.7	209.2	216.4	239.5	248.9	261.6	270.6	299.5	311.2	
4	saturated top soil	120	181.0	236.1	283.3	270.7	275.5	295.2	354.2	338.5	344.4	
4	dry clay	125	204.9	262.3	295.1	295.1	299.2	328.0	369.0	369.0	374.1	
4	saturated clay	130	230.2	281.4	306.9	313.8	319.7	351.8	383.8	392.3	399.8	
5	granular w/o cohesion	100	147.6	223.0	245.9	249.2	268.9	278.8	307.5	311.6	336.2	
5	sand and gravel	110	176.7	245.3	281.4	288.6	306.6	306.7	351.8	360.8	383.4	
5	saturated top soil	120	208.6	275.5	306.9	314.8	338.4	344.4	383.8	393.6	423.1	
5	dry clay	125	229.5	295.1	344.3	360.7	366.9	369.0	430.5	451.0	458.7	
5	saturated clay	130	255.8	324.0	345.3	392.2	392.2	405.1	431.7	490.4	490.4	
6	granular w/o cohesion	100	150.8	229.5	275.5	314.8	288.6	287.0	344.4	393.6	360.8	
6	sand and gravel	110	187.6	274.1	313.8	346.3	324.6	342.8	392.4	433.0	405.9	
6	saturated top soil	120	220.4	314.8	354.2	393.5	373.8	393.6	442.8	492.0	467.4	
6	dry clay	125	245.9	344.3	393.5	409.9	409.9	430.5	492.0	512.5	512.5	
6	saturated clay	130	289.9	375.1	434.8	443.3	447.6	469.0	543.7	554.3	559.7	
8	granular w/o cohesion	100	164.0	268.9	314.8	367.3	393.5	336.2	393.6	459.2	492.0	
8	sand and gravel	110	202.0	317.4	378.7	418.4	432.9	396.9	473.6	523.2	541.2	
8	saturated top soil	120	240.0	362.0	425.0	472.2	491.9	452.6	531.4	590.4	615.0	
8	dry clay	125	278.7	409.9	442.7	524.7	532.9	512.5	553.5	656.0	666.3	
8	saturated clay	130	324.0	460.4	511.6	579.8	596.8	575.6	639.6	724.9	746.2	
10	granular w/o cohesion	100	167.2	295.1	364.0	446.0	459.1	369.0	455.1	557.6	574.0	
10	sand and gravel	110	209.2	353.5	432.8	490.6	523.0	442.0	541.2	613.4	654.0	
10	saturated top soil	120	251.8	417.1	507.6	550.9	590.3	521.5	634.7	688.8	738.0	
10	dry clay	125	303.3	459.1	541.1	590.3	647.6	574.0	676.5	738.0	809.8	
10	saturated clay	130	341.0	511.6	588.3	648.0	724.7	639.6	735.5	810.2	906.1	
15	granular w/o cohesion	100	170.5	321.4	442.7	511.6	508.3	401.8	553.5	639.6	635.5	
15	sand and gravel	110	216.4	396.8	487.0	634.8	667.3	496.1	608.9	793.8	834.4	
15	saturated top soil	120	259.7	472.2	637.5	724.0	787.0	590.4	797.0	905.3	984.0	
15	dry clay	125	315.6	541.1	688.6	787.0	860.8	676.5	861.0	984.0	1076.3	
15	saturated clay	130	383.7	639.4	767.3	852.6	937.8	799.5	959.4	1066.0	1172.6	
20	granular w/o cohesion	100	170.5	334.5	472.2	590.3	672.2	418.2	590.4	738.0	840.5	
20	sand and gravel	110	216.4	418.4	584.3	707.0	811.6	523.2	730.6	884.0	1014.8	
20	saturated top soil	120	259.7	503.7	684.7	834.2	905.1	629.8	856.1	1043.0	1131.6	
20	dry clay	125	319.7	606.6	787.0	918.2	1024.7	758.5	984.0	1148.0	1281.3	
20	saturated clay	130	383.7	682.1	908.0	1023.1	1151.0	852.8	1135.3	1279.2	1439.1	
25	granular w/o cohesion	100	170.5	341.0	491.9	616.5	737.8	426.4	615.0	770.8	922.5	
25	sand and gravel	110	216.4	432.9	606.0	750.3	883.7	541.2	757.7	938.1	1105.0	
25	saturated top soil	120	259.7	511.6	720.1	881.4	1042.8	639.6	900.4	1102.1	1303.8	
25	dry clay	125	319.7	623.0	860.8	1016.5	1147.7	779.0	1076.3	1271.0	1435.0	
25	saturated clay	130	383.7	733.2	997.5	1176.6	1278.9	916.8	1247.2	1471.1	1599.0	
30	granular w/o cohesion	100	170.5	341.0	501.7	642.7	770.6	426.4	627.3	803.6	963.5	
30	sand and gravel	110	216.4	432.9	627.6	793.6	937.8	541.2	784.7	992.2	1172.6	
30	saturated top soil	120	259.7	519.4	755.5	944.4	1101.8	649.4	944.6	1180.8	1377.6	
30	dry clay	125	319.7	631.2	910.0	1082.1	1250.2	789.3	1137.8	1353.0	1563.1	
30	saturated clay	130	383.7	750.3	1023.1	1278.9	1449.4	938.1	1279.2	1599.0	1812.2	
40	granular w/o cohesion	100	170.5	341.0	511.6	669.0	819.8	426.4	639.6	836.4	1025.0	
40	sand and gravel	110	216.4	432.9	649.3	836.8	1010.0	541.2	811.8	1046.3	1262.8	
40	saturated top soil	120	259.7	519.4	779.1	1007.4	1200.2	649.4	974.2	1259.5	1500.6	
40	dry clay	125	319.7	639.4	934.6	1213.3	1434.6	799.5	1168.5	1517.0	1793.8	
40	saturated clay	130	383.7	767.3	1138.2	1364.1	1619.9	959.4	1423.1	1705.6	2025.4	
50	granular w/o cohesion	100	170.5	341.0	511.6	682.1	836.2	426.4	639.6	852.8	1045.5	
50	sand and gravel	110	216.4	432.9	649.3	865.7	1046.1	541.2	811.8	1082.4	1307.9	
50	saturated top soil	120	259.7	519.4	779.1	1023.1	1259.2	649.4	974.2	1279.2	1574.4	
50	dry clay	125	319.7	639.4	959.2	1262.5	1516.6	799.5	119.3	1578.5	1896.3	
50	saturated clay	130	383.7	767.3	1151.0	1466.4	1705.2	959.4	1439.1	1833.5	2132.0	

Depth (of burial) is in feet; Soil Wgt (weight) is in lbs/ft³; values in the body of the table are in lbs of soil load per linear foot (lbs/linear ft).

Table B-2. Marston Soil Load Values for Asahi/America Pipe (continued)

Depth	Soil Type	Soil Wgt	Nominal Piping Diameter = 12 Inches				Nominal Piping Diameter = 14 Inches				Nominal Piping Diameter = 16 Inches			
			Width of Trench in Feet				Width of Trench in Feet				Width of Trench in Feet			
			2	3	4	5	2	3	4	5	2	3	4	5
3	granular w/o cohesion	100	248	254.2	268.7	273.8	279.6	286.6	302.9	308.7	315	322.9	341.3	347.8
3	sand & gravel	110	272.8	289.8	295.5	301.2	307.6	326.8	333.2	339.6	346.5	368.2	375.4	382.6
3	saturated top soil	120	310	319.9	332.3	341	349.5	360.7	374.7	384.5	393.8	406.4	422.1	433.1
3	dry clay	125	322.9	348.7	361.7	361.7	364.1	393.2	407.8	407.8	410.2	443	459.4	459.4
3	saturated clay	130	349.3	370.8	381.5	389.6	393.8	418	430.1	439.2	443.6	470.9	484.6	494.8
4	granular w/o cohesion	100	289.3	310	338.9	351.3	326.2	349.5	382.1	396.1	367.5	393.8	430.5	446.3
4	sand & gravel	110	329.6	341	377.4	392.1	371.6	384.5	425.5	442.1	418.7	433.1	479.3	498.1
4	saturated top soil	120	372	446.4	426.6	434	419.4	503.3	480.9	489.3	472.5	567	541.8	551.3
4	dry clay	125	413.3	465	465	471.5	466	524.3	524.3	531.5	525	590.6	590.6	598.8
4	saturated clay	130	443.3	483.6	494.3	503.8	499.8	545.2	557.3	567.9	563.1	614.3	627.9	639.8
5	granular w/o cohesion	100	351.3	387.5	392.7	423.7	396.1	436.9	442.7	477.7	446.3	492.2	498.8	538.1
5	sand & gravel	110	386.5	443.3	454.7	483.1	435.7	499.8	512.6	544.6	490.9	563.1	577.5	613.6
5	saturated top soil	120	434	483.6	496	533.2	489.3	545.2	559.2	601.1	551.3	614.3	630	677.3
5	dry clay	125	465	542.5	568.3	578	524.3	611.6	640.8	651.7	590.6	689.1	721.9	734.2
5	saturated clay	130	510.5	544.1	617.9	617.9	575.5	613.4	696.7	696.7	648.4	691	784.9	784.9
6	granular w/o cohesion	100	361.7	434	496	454.7	407.8	489.3	559.2	512.6	459.4	551.3	630	577.5
6	sand & gravel	110	431.9	494.4	545.6	511.5	487	557.5	615.1	576.7	548.6	628	693	649.7
6	saturated top soil	120	496	558	620	589	559.2	629.1	699	664.1	630	708.8	787.5	748.1
6	dry clay	125	542.5	620	645.8	645.8	611.6	699	728.1	728.1	689.1	787.5	820.3	820.3
6	saturated clay	130	591.1	685.1	698.5	705.3	666.4	772.4	787.5	795.1	750.8	870.2	887.3	895.8
8	granular w/o cohesion	100	423.7	496	578.7	620	477.7	559.2	652.4	699	538.1	630	735	787.5
8	sand & gravel	110	500.1	596.7	659.3	682	563.9	672.8	743.3	768.9	635.3	758	837.4	866.3
8	saturated top soil	120	570.4	669.6	744	775	643.1	754.9	838.8	873.8	724.5	850.5	945	984.4
8	dry clay	125	645.8	697.5	826.7	839.6	728.1	786.4	932	946.6	820.3	885.9	1050	1066.4
8	saturated clay	130	725.4	806	913.5	940.3	817.8	908.7	1029.9	1060.2	921.4	1023.8	1160.3	1194.4
10	granular w/o cohesion	100	465	573.5	702.7	723.3	524.3	646.6	792.2	815.5	590.6	728.4	892.5	918.8
10	sand & gravel	110	557	682	772.9	824.1	627.9	768.9	871.4	929.1	707.4	866.3	981.8	1046.7
10	saturated top soil	120	657.2	799.8	868	930	740.9	901.7	978.6	1048.5	834.8	1015.9	1102.5	1181.3
10	dry clay	125	723.3	852.5	930	1020.4	815.5	961.1	1048.5	1150.4	918.8	1082.8	1181.3	1296.1
10	saturated clay	130	806	926.9	1020.9	1141.8	908.7	1045	1151	1287.3	1023.8	1177.3	1296.8	1450.3
15	granular w/o cohesion	100	506.3	697.5	806	800.8	570.9	786.4	908.7	902.9	643.1	885.9	1023.8	1017.2
15	sand & gravel	110	625.2	767.2	1000.3	1051.4	704.8	865	1127.7	1185.4	794.1	974.5	1270.5	1335.5
15	saturated top soil	120	744	1004.4	1140.8	1240	838.8	1132.4	1286.2	1398	945	1275.8	1449	1575
15	dry clay	125	852.5	1085	1240	1356.3	961.1	1223.3	1398	1529.1	1082.8	1378.1	1575	1722.7
15	saturated clay	130	1007.5	1209	1343.3	1477.7	1135.9	1363.1	1514.5	1666	1279.7	1535.6	1706.3	1876.9
20	granular w/o cohesion	100	527	744	930	1059.2	594.2	838.8	1048.5	1194.1	669.4	945	1181.3	1345.3
20	sand & gravel	110	659.3	920.7	1113.9	1278.8	743.3	1038	1255.9	1441.7	837.4	1169.4	1414.9	1624.2
20	saturated top soil	120	793.6	1078.8	1314.4	1426	894.7	1216.3	1481.9	1607.7	1008	1370.3	1669.5	1811.3
20	dry clay	125	955.8	1240	1446.7	1614.6	1077.6	1398	1631	1820.3	1214.1	1575	1837.5	2050.8
20	saturated clay	130	1074.7	1430.7	1612	1813.5	1211.6	1612.9	1817.4	2044.6	1365	1817.2	2047.5	2303.4
25	granular w/o cohesion	100	537.3	775	971.3	1162.5	605.8	873.8	1095.1	1310.6	682.5	984.4	1233.8	1476.6
25	sand & gravel	110	682	954.8	1182.1	1392.4	768.9	1076.5	1332.8	1569.8	866.3	1212.8	1501.5	1768.6
25	saturated top soil	120	806	1134.6	1388.8	1643	908.7	1279.2	1565.8	1852.4	1023.8	1441.1	1764	2086.9
25	dry clay	125	981.7	1356.2	1601.7	1808.3	1106.8	1529.1	1805.8	2038.8	1246.9	1722.7	2034.4	2296.9
25	saturated clay	130	1155.3	1571.7	1853.8	2015	1302.5	1772	2090	2271.8	1467.4	1996.3	2354.6	2559.4
30	granular w/o cohesion	100	537.3	790.5	1012.7	1214.2	605.8	891.2	1141.7	1368.9	682.5	1004.1	1286.3	1542.2
30	sand & gravel	110	682	988.9	1250.3	1477.7	768.9	1114.9	1409.7	1666	866.3	1256.1	1588.1	1876.9
30	saturated top soil	120	818.4	1190.4	1488	1736	922.7	1342.1	1677.6	1957.2	1039.5	1512	1890	2205
30	dry clay	125	994.6	1433.7	1705	1969.8	1121.3	1616.4	1922.3	2220.8	1263.3	1821.1	2165.6	2502
30	saturated clay	130	1182.1	1612	2015	2283.7	1332.8	1817.4	2271.8	2574.7	1501.5	2047.5	2559.4	2900.6
40	granular w/o cohesion	100	537.3	806	1054	1291.7	605.8	908.7	1188.3	1456.3	682.5	1023.8	1338.8	1640.6
40	sand & gravel	110	682	1023	1318.5	1591.3	768.9	1153.4	1486.5	1794.1	866.3	1299.4	1674.8	2021.3
40	saturated top soil	120	818.4	1227.6	1587.2	1891	922.7	1384	1789.4	2132	1039.5	1559.3	2016	2401.9
40	dry clay	125	1007.5	1472.5	1911.7	2260.4	1135.9	1660.1	2155.3	2548.4	1279.7	1870.3	2428.1	2871.1
40	saturated clay	130	1209	1793.4	2149.3	2552.3	1363.1	2021.9	2423.2	2877.6	1535.6	2277.8	2730	3241.9
50	granular w/o cohesion	100	537.3	806	1074.7	1317.5	605.8	908.7	1211.6	1485.4	682.5	1023.8	1365	1673.4
50	sand & gravel	110	682	1023	1364	1648.2	768.9	1153.4	1537.8	1858.2	866.3	1299.4	1732.5	2093.4
50	saturated top soil	120	818.4	1227.6	1612	1984	922.7	1384	1817.4	2236.8	1039.5	1559.3	2047.5	2520
50	dry clay	125	1007.5	1511.2	1989.2	2389.6	1135.9	1703.8	2242.6	2694.1	1279.7	1919.5	2526.6	3035.2
50	saturated clay	130	1209	1813.5	2310.5	2686.7	1363.1	2044.6	2604.9	3029	1535.6	2303.4	2934.8	3412.5

B

Table B-2. Marston Soil Load Values for Asahi/America Pipe (continued)

Depth	Soil Type	Soil Wgt	Nominal Piping Dia = 18"				Nominal Piping Dia = 20"			Nominal Piping Dia = 24"		
			Width of Trench in Feet				Width of Trench in Feet			Width of Trench in Feet		
			2	3	4	5	3	4	5	3	4	5
3	granular w/o cohesion	100	354.4	363.3	383.9	391.3	403.6	426.6	434.8	508.4	537.3	547.7
3	sand and gravel	110	389.8	414.2	422.3	430.4	460.3	469.3	478.3	579.7	591.1	602.4
3	saturated top soil	120	443.0	457.2	474.9	487.3	508.0	527.7	541.5	639.8	664.6	682.0
3	dry clay	125	461.5	498.4	516.8	516.8	553.8	574.3	574.3	697.5	723.3	723.3
3	saturated clay	130	499.1	529.8	545.2	556.7	588.7	605.8	618.6	741.5	763.0	779.1
4	granular w/o cohesion	100	413.5	443.0	484.3	502.1	492.2	538.2	557.9	620.0	677.9	702.7
4	sand and gravel	110	471.1	487.3	539.3	560.4	541.5	599.2	622.7	682.0	754.7	784.3
4	saturated top soil	120	531.6	637.9	609.6	620.2	708.8	677.3	689.2	892.8	853.1	868.0
4	dry clay	125	590.7	664.5	664.5	673.7	738.4	738.4	748.6	930.0	930.0	942.9
4	saturated clay	130	633.5	691.1	706.4	719.9	767.9	785.0	799.9	967.2	988.7	1007.5
5	granular w/o cohesion	100	502.1	553.8	561.1	605.4	615.3	623.5	672.7	775.0	785.3	847.3
5	sand and gravel	110	552.3	633.5	649.7	690.3	703.9	722.0	767.1	886.6	909.3	966.2
5	saturated top soil	120	620.2	691.1	708.8	762.0	767.9	787.6	846.7	967.2	992.0	1066.4
5	dry clay	125	664.5	775.3	812.2	826.0	861.4	902.5	917.8	1085.0	1136.7	1156.0
5	saturated clay	130	729.5	777.5	883.0	883.0	863.9	981.2	981.2	1088.1	1235.9	1235.9
6	granular w/o cohesion	100	516.8	620.2	708.8	649.7	689.1	787.6	722.0	868.0	992.0	909.3
6	sand and gravel	110	617.2	706.6	779.7	731.0	785.1	866.4	812.2	988.9	1091.2	1023.0
6	saturated top soil	120	708.8	797.4	886.0	841.7	886.1	984.5	935.3	1116.0	1240.0	1178.0
6	dry clay	125	775.3	886.0	922.9	922.9	984.5	1025.5	1025.5	1240.0	1291.7	1291.7
6	saturated clay	130	844.7	979.0	998.2	1007.8	1087.9	1109.2	1119.9	1370.2	1397.1	1410.5
8	granular w/o cohesion	100	605.4	708.8	826.9	886.0	787.6	918.9	984.5	992.0	1157.3	1240.0
8	sand and gravel	110	714.7	852.8	942.1	974.6	947.6	1046.9	1083.0	1193.5	1318.5	1364.0
8	saturated top soil	120	815.1	956.9	1063.2	1107.5	1063.3	1181.4	1230.6	1339.2	1488.0	1550.0
8	dry clay	125	922.9	996.8	1181.3	1199.8	1107.6	1312.7	1333.2	1395.0	1653.3	1679.2
8	saturated clay	130	1036.6	1151.8	1305.4	1343.8	1279.9	1450.5	1493.2	1612.0	1826.9	1880.7
10	granular w/o cohesion	100	664.5	819.6	1004.1	1033.7	910.7	1115.8	1148.6	1147.0	1405.3	1446.7
10	sand and gravel	110	795.9	974.6	1104.5	1177.6	1083.0	1227.3	1308.6	1364.0	1545.9	1648.2
10	saturated top soil	120	939.2	1142.9	1240.4	1329.0	1270.0	1378.3	1476.8	1599.6	1736.0	1860.0
10	dry clay	125	1033.7	1218.3	1329.0	1458.2	1353.7	1476.8	1620.3	1705.0	1860.0	2040.8
10	saturated clay	130	1151.8	1324.6	1458.9	1631.7	1471.8	1621.1	1813.1	1853.8	2041.9	2283.7
15	granular w/o cohesion	100	723.6	996.8	1151.8	1144.4	1107.6	1279.9	1271.6	1395.0	1612.0	1601.7
15	sand and gravel	110	893.4	1096.4	1429.4	1502.5	1218.3	1588.3	1669.5	1534.5	2000.5	2102.8
15	saturated top soil	120	1063.2	1435.3	1630.2	1772.0	1594.9	1811.5	1969.0	2008.8	2281.6	2480.0
15	dry clay	125	1218.3	1550.5	1772.0	1938.1	1722.9	1969.0	2153.6	2170.0	2480.0	2712.5
15	saturated clay	130	1439.8	1727.7	1919.7	2111.6	1919.8	2133.1	2346.4	2418.0	2686.7	2955.3
20	granular w/o cohesion	100	753.1	1063.2	1329.0	1513.6	1181.4	1476.8	1681.9	1488.0	1860.0	2118.3
20	sand and gravel	110	942.1	1315.7	1591.8	1827.4	1462.0	1768.8	2030.5	1841.4	2227.9	2557.5
20	saturated top soil	120	1134.1	1541.6	1878.3	2037.8	1713.0	2087.1	2264.4	2157.6	2628.8	2852.0
20	dry clay	125	1365.9	1772.0	2067.3	2307.3	1969.0	2297.2	2563.8	2480.0	2893.3	3229.2
20	saturated clay	130	1535.7	2044.4	2303.6	2591.6	2271.7	2559.7	2879.7	2861.3	3224.0	3627.0
25	granular w/o cohesion	100	767.9	1107.5	1388.1	1661.3	1230.6	1542.4	1845.9	1550.0	1942.7	2325.0
25	sand and gravel	110	974.6	1364.4	1689.3	1989.8	1516.1	1877.1	2211.0	1909.6	2364.3	2784.8
25	saturated top soil	120	1151.8	1621.4	1984.6	2347.9	1801.6	2205.3	2608.9	2269.2	2777.6	3286.0
25	dry clay	125	1402.8	1938.1	2288.8	2584.2	2153.6	2543.3	2871.5	2712.5	3203.3	3616.7
25	saturated clay	130	1650.9	2246.0	2649.1	2879.5	2495.7	2943.7	3199.6	3143.4	3707.6	4030.0
30	granular w/o cohesion	100	767.9	1129.7	1447.1	1735.1	1255.2	1608.0	1928.0	1581.0	2025.3	2428.3
30	sand and gravel	110	974.6	1413.2	1786.8	2111.6	1570.3	1985.4	2346.4	1977.8	2500.7	2955.3
30	saturated top soil	120	1169.5	1701.1	2126.4	2480.8	1890.2	2362.8	2756.6	2380.8	2976.0	3472.0
30	dry clay	125	1421.3	2048.9	2436.5	2814.9	2276.7	2707.4	3127.8	2867.5	3410.0	3939.6
30	saturated clay	130	1689.3	2303.6	2879.5	3263.4	2559.7	3199.6	3626.2	3224.0	4030.0	4567.3
40	granular w/o cohesion	100	767.9	1151.8	1506.2	1845.8	1279.9	1673.7	2051.0	1612.0	2108.0	2583.3
40	sand and gravel	110	974.6	1461.9	1884.2	2274.1	1624.4	2093.7	2526.9	2046.0	2637.1	3182.7
40	saturated top soil	120	1169.5	1754.3	2268.2	2702.3	1949.3	2520.3	3002.7	2455.2	3174.4	3782.0
40	dry clay	125	1439.8	2104.3	2731.8	3230.2	2338.2	3035.5	3589.3	2945.0	3823.3	4520.8
40	saturated clay	130	1727.7	2562.8	3071.5	3647.4	2847.7	3412.9	4052.9	3586.7	4298.7	5104.7
50	granular w/o cohesion	100	767.9	1151.8	1535.7	1882.8	1279.9	1706.5	2092.1	1612.0	2149.3	2635.0
50	sand and gravel	110	974.6	1461.9	1949.2	2355.3	1624.4	2165.9	2617.1	2046.0	2728.0	3296.3
50	saturated top soil	120	1169.5	1754.3	2303.6	2835.2	1949.3	2559.7	3150.4	2455.2	3224.0	3968.0
50	dry clay	125	1439.8	2159.6	2842.6	3414.8	2399.7	3158.6	3794.4	3022.5	3978.3	4779.2
50	saturated clay	130	1727.7	2591.6	3301.8	3839.3	2879.7	3668.9	4266.2	3627.0	4621.1	5373.3

Depth (of burial) is in feet; Soil Wgt (weight) is in lbs/ft³; values in the body of the table are in lbs of soil load per linear foot (lbs/linear ft).

Table B-3. Average Values of Modulus of Soil Reaction, E' (for initial flexible pipe deflection)

Soil type-pipe bedding material (Unified Classification System) (1)	E' for Degree of Compaction of Bedding, (in pounds per square inch)			
	Dumped D umped (2)	Slight, <85% Proctor, <40% Relative Density (3)	Moderate, 85%-90% Proctor, 40%-70% Relative Density (4)	High, >95% Proctor, >70% (5)
Fine-grained Soils (LL > 50) ^b Soils with medium to high plasticity CH, MH, CH-MH	No data available; consult a competent soils engineer; otherwise use E' = 0			
Fine-grained Soils (LL < 50) Soils with medium to no plasticity CL, ML, ML-CL, with less than 25% coarse-grained particles	50	200	400	1,000
Fine-grained Soils (LL < 50) Soils with medium to no plasticity CL, ML, ML,CL, with more than 25% coarse-grained particles Coarse-grained Soils with Fines GM, GC, SM, SC ^c contains more than 12% fines	100	400	1,000	2,000
Coarse-grained Soils with Little or No Fines CW, CP, SW, SP ^c contains less than 12% fines	200	1,000	2,000	3,000
Crushed Rock	1,000	3,000	3,000	3,000
Accuracy in Terms of Percentage Deflection ^d	□2	□2	□1	□0.5

^a ASTM Designation D-2487, USBR Designation E-3.

^b LL = Liquid limit.

^c Or any borderline soil beginning with one of these symbols (i.e., GM-GC, GC-SC).

^d For □1 % accuracy and predicted deflection of 3%, actual deflection would be between 2% and 4%.

Note: Values applicable only for fills less than 50 ft (15m). Table does not include any safety factor. For use in predicting initial deflections only, appropriate Deflection Lag Factor must be applied for long-term deflections. If bedding falls on the borderline between two compaction categories, select lower E' value or average the two values. Percentage Proctor based on laboratory maximum dry density from test standards using about 12,500 ft-lb/cu ft (598,000 J/m³) (ASTM D-698, AASHTO T-99, USBR Designation E-1 1). 1 psi = 6.9 kN/M².

Source: "Soil Reaction for Buried Flexible Pipe" by Amster K. Howard, U.S. Bureau of Reclamation, Denver, Colorado. Reprinted with permission from American Society of Civil Engineers' *Journal of Geotechnical Engineering Division*. January 1977, PP. 33-43.

Table B-4. Values of Bedding Constant, K

Bedding Angle (degrees)	K
0	0.110
30	0.108
45	0.105
60	0.102
90	0.096
120	0.090
180	0.083

This page intentionally left blank.

PRODUCTS OFFERED:

SINGLE WALL PIPING SYSTEMS

HIGH PURITY PIPING SYSTEMS

- Purad® Ultra - High Purity PVDF
- PolyPure® - Natural PP
- PP-Pure® - Pigmented PP
- Purflon® - PFA

INDUSTRIAL PIPING SYSTEMS

- Chem Proline® - PE
- Proline® - Industrial PP
- Super Proline® - Chem Grade PVDF
- Ultra Proline® - Halar® (E-CFTE)

AIR AND GAS HANDLING PIPING SYSTEMS

- Air-Pro® - Compressed Air
- PureVent® - PVDF Duct System
- ProVent® - PP Duct System

DOUBLE WALL PIPING SYSTEMS

DOUBLE CONTAINED PIPING SYSTEMS

- Duo-Pro® - Engineered PP, PVDF & Halar® (E-CFTE)
- Chem Prolok™ - PE
- Poly-Flo® - PP and HDPE
- Pro-Lock® - PVC and CPVC
- Fluid-Lok® - HDPE

OTHER PRODUCTS

- Asahi Thermoplastic Valves and Actuators
- Dymatrix™ - Specialized Wet Process Valves
- Frank Series Regulators - PVDF, PP, Halar® (E-CFTE)
- EM-Technik™ - Tubing System
- Polytetra™ - Heaters and Heat Exchangers

MARKETS SERVED

- Chemical Processing
- Petrochemical
- Mining
- Pulp and Paper
- Plating
- Pharmaceutical
- Food
- Semiconductor Processing
- Municipal & Industrial Water
- Wastewater Treatment
- Aquariums
- Landfill Recovery
- Ultra Pure Water
- Theme Parks
- Cruise Ship Construction
- Solar Panel Manufacturing
- Ethanol Production
- Railroad Yard Switching Systems

Another Corrosion Problem Solved.TM



655 Andover St., Lawrence, MA 01843

Tel: 800-343-3618; 781-321-5409

Direct Sales: East: (800) 232-7244
Central: (800) 442-7244
West (800) 282-7244

Fax: 800-787-68614

www.asahi-america.com

asahi@asahi-america.com