

ASAHIPUR[®]

High Purity Piping Systems

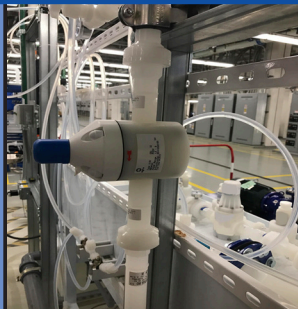

Purad[®] • PolyPure[®] • PP-Pure[®]
Frank Regulators • SP Series Welding Equipment

The
Wet
Process
People[™]



ASAHI/AMERICA[®]
Your Experts in Plastics[™]

www.asahi-america.com

High Purity and Wet Process Solutions

Asahi/America offers the most advanced high purity product line on the market. Our complete product offering provides a single source solution. This extensive product selection is supported by an experienced and knowledgeable group of staff engineers, technicians and sales agents, all ready to assist you with your application requirements.

High Purity Piping System

Asahi/America features three system choices to meet every customer's purity and cost requirements. Purad® UHP PVDF is our premier high purity system for the most stringent applications. PolyPure® natural polypropylene and PP-Pure® pigmented polypropylene offer cost effective solutions for institutional applications.



Specialty Fittings

Our standard fitting range is complimented by a wide variety of specialty fittings, which are machined and fabricated by Asahi/America. Our highly efficient Massachusetts-based manufacturing facility produces the fastest turn-around time in the industry.



IR Welding Equipment

The fully automated SP series of IR fusion equipment provides unmatched reliability and ease of use. Our exclusive force control welding technology eliminates operator influence and prevents cold welds.



Diaphragm and Sampling Valves

We offer a complete range of diaphragm, zero dead leg and sampling valves for our high purity piping systems. Our NVM UPW sampling valve provides cutting edge purity in its design.



Frank Regulators

The Frank series of regulating products includes pressure regulators, back pressure regulators, pressure relief valves and manual flow meters. These high quality products provide superior pressure and flow control for high purity piping systems.



Custom Products

We offer a wide variety of ISO 9001 manufacturing capabilities for custom products including precision machining, system fabrication, final assembly and engineering design. Our specialties include piping skids, valve boxes, process systems and custom vessels.



AGRU High Purity Manufacturing

High Purity Factory

AGRU features five plants on their Bad Hall, Austria manufacturing campus. Plants features the latest manufacturing technology and largest capacity for producing high purity piping systems. The plant was designed and built for full optimization and efficient process flow. Significant investments were made into brand new molding, extrusion, water treatment and clean room equipment to ensure the highest purity of the facility and finished products.



The Plastics Experts.



Extended Product Range

AGRU continues to build upon their range of complete fittings and valves. We offer our T-343 Zero Deadleg Diaphragm Valves in the largest molded size range on the market up to 160mm (6") main. The outer shoulder of our union fittings were optimized to provide visual indication of tightness. The new instrument port fitting features and integrate shoulder port with PEEK threaded insert. This allows long probes to sit inside the pipe wall and maintains a sturdy connection.



**Zero Deadleg
Diaphragm Valves**
(shown with sanitary ends)



Union



**Instrumentation
Port**



Purad® UHP PVDF is the premier product for high purity water systems. The SOLEF™ PVDF resin we carefully selected and our stringent cleanroom manufacturing process provides the cleanest piping material available. Purad® is the best choice for systems with critical requirements for water quality.



Purad® is the only system with a complete range of fittings in the thin wall SDR33 (150psi) for 3" and 4" (90 and 110mm) sizes. This option provides a significant cost savings for Asahi/America customers.

Supply Range

Pipe and Fittings

- 20-315mm (1/2" - 12") SDR21, 230psi
- 90-315mm (3" - 12") SDR33, 150psi

Valves

- T-342 diaphragm valves: 20-110mm (1/2" - 4")
- T-343 zero dead leg (ZDL) valves: 20-110mm (1/2" - 6")
- Type-21 ball valves: 20-110mm (1/2" - 4")
- Frank series regulating valves: 20-75mm (1/2" - 2-1/2")

Seals and O-rings

- Diaphragm valves and regulators: PTFE
- Ball valves and unions: FKM (PTFE available)

Welding Methods



Pressure Rating

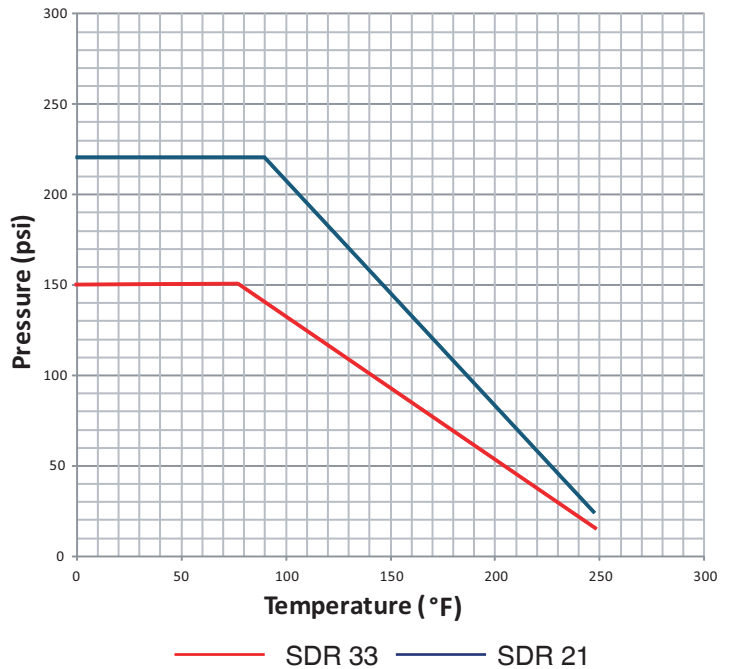

Resin & Manufacturing



At the core of the Purad® system is its resin. Utilizing only high purity grades of Solvay Polymer's SOLEF™ 1000 series resins, Purad® provides unmatched quality and low leachouts for all of its pipe, fittings, valves, and raw material. Absolutely no stabilizers, additives or processing agents are used during production.

Purad® pipe, fittings and valves are extruded and molded under ISO Class V (Class 100) conditions in Agru's cutting edge Plant 5. The fittings are cleaned in an automated HUPW bath system. Fittings and valves are double bagged in anti-static and anti-tear bags. The pipe receives three layers of purity protection consisting of end sleeves and caps, full bagging, and an outer PE tube. The outer PE tube protects from shipping damage and may be wiped clean for storage in clean areas.

Pipe sizes 20 - 32mm (1/2" - 1") are bagged in multiple lengths per bag.

POLYPURE Natural PP-R Piping System



PolyPure® natural polypropylene systems provide excellent high purity performance and cost effective installation. PolyPure® systems are specified and installed with confidence for a variety of high purity applications including USP purified water, institutional laboratory, deionized water and RO water systems.



PolyPure® is fully pressure rated to 150psi across the entire size range and does not derate in larger diameters like competitive systems.

Supply Range

Pipe and Fittings

- 20-110mm (1/2" - 4") SDR11, 150psi

Valves

- T-342 diaphragm valves: 20-63mm (1/2" - 2")
- T-343 zero dead leg (ZDL) valves: 20-63mm (1/2" - 2")
- Ball valves: 20 - 63mm (1/2" - 2")
- 3" and 4" valves: Only available in PP

Seals and O-rings

- Diaphragm valves and regulators: EPDM or PTFE
- Ball valves and unions: FKM (PTFE and EPDM available)

Welding Methods



Pressure Rating

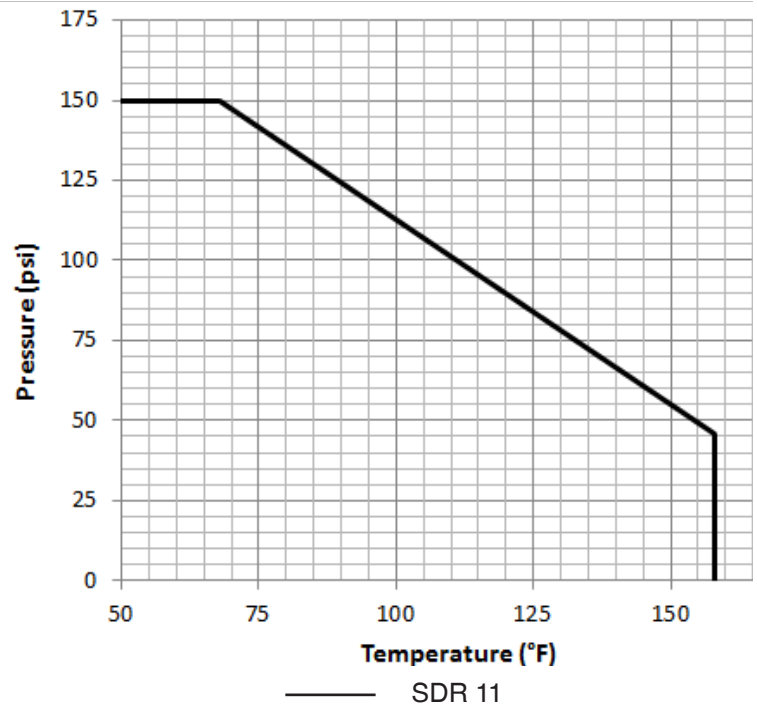

Resin & Manufacturing

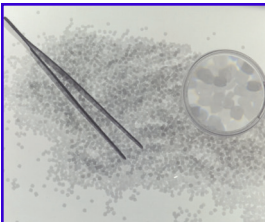

The PolyPure® system uses a virgin, natural random copolymer polypropylene resin (PP-R) for its pipe, fittings and valves.

PolyPure® components are extruded in a clean area. Pipe receives end sleeves and caps, and an outer full bag. Fittings and valves are brought to plant 5 for automated cleaning and single bagging.

Pipe sizes 20-32mm (1/2" - 1") are bagged in multiple lengths per bag.



PP-PURE Pigmented PP Piping System



PP-Pure® pigmented polypropylene systems provide a wide size range and the best cost savings on large scale water systems up to 12". This system is commonly considered for large diameter non-critical UPW lines for the semiconductor and photovoltaic industries.



Supply Range

Pipe and Fittings

- 20-315mm (1/2" - 12") SDR11, 150psi

Valves

- T-342 diaphragm valves: 20-110mm (1/2" - 4")
- T-343 zero dead leg (ZDL) valves: 20-63mm (1/2" - 2")
- Type-21 ball valves: 20-110mm (1/2" - 4")

Seals and O-rings

- Diaphragm valves and regulators: EPDM or PTFE
- Ball valves and unions: FKM (EPDM available)

Welding Methods



Pressure Rating

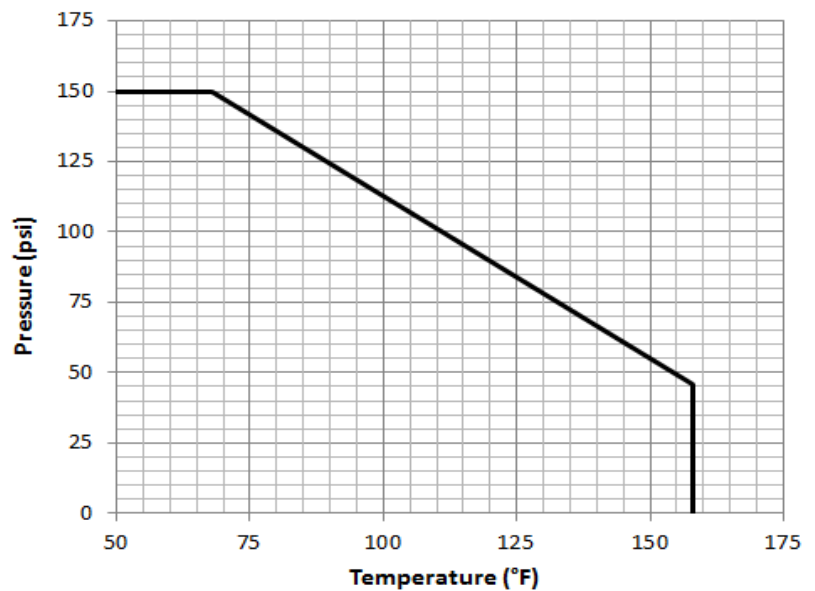

— SDR 11

Resin & Manufacturing



The PP-Pure® system uses a pigmented random copolymer polypropylene resin (PP-R) for its pipe, fittings and valves.



PP-Pure® components are extruded in a clean area. Pipe receives end sleeves and caps, and an outer full bag. Fittings and valves are brought to Plant 5 for automated cleaning and double bagged

Pipe sizes 20-32mm (1/2" - 1") are bagged in multiple lengths per bag.



High Purity Valves

T-342 and T-343 Diaphragm Valves



- Valves are cleanroom produced, assembled and packaged
- All valves come standard with integral lock out device to prevent unauthorized cycling
- Valves are 150psi rated at 68°F and designed for high temperature service
- Fully serviceable with replacement diaphragms available

Specifications

Body Material: Purad® PVDF, PolyPure® PP-R and PP-Pure® pigmented

Diaphragm: PTFE or EPDM (PP only)

Bonnet Material: PPG

Maximum Pressure: 150psi at 68°F

Size Range

Purad® UHP PVDF

- T-342 diaphragm valves: 20-110mm (1/2" - 4")
- T-343 zero dead leg (ZDL) valves: 20-110mm (1/2" - 4")

PolyPure® Natural Polypropylene

- T-342 diaphragm valves: 20-63mm (1/2" - 2")
- T-343 zero dead leg (ZDL) valves: 20-63mm (1/2" - 2")

PP-Pure® Pigmented Polypropylene

- T-342 diaphragm valves: 20-110mm (1/2" - 4")
- T-343 zero dead leg (ZDL) valves: 20-63mm (1/2" - 2")

Actuation Options



- Air-to-spring (open and closed)
- Air-to-air
- Min/max stroke limiter
- Electric position feedback
- Magnetic position feedback
- Manual override handwheel
- Pilot Solenoid Valve

ZDL Diaphragm Valves



Zero Deadleg Valve

ZDL diaphragm valves eliminate dead space where bacteria can grow. All valves come standard with integral lock out device to prevent unauthorized cycling. Now available in up to 160mm (6").

Sampling Valves



Purad® Labcock Valve

This quarter-turn valve provides a basic and cost effective solution for sampling. Available in 1/4" male NPT and PVDF only.



EMT Needle Valve

The needle design allows flow rate regulation at an affordable price. Available in angle and straight configurations with NPT and IR spigot ends.



MPV Sampling Valves

Dymatrix™



- Valve is rigidly bolted to body to prevent damage
- Inline sampling valve assembly eliminates dead leg and crevices
- Clean PTFE diaphragm material
- Poppet diaphragm close to mainline
- Proven Dymatrix™ MPV valve and bonnet technology
- Manual Push2Lock™ handle is easy to use

Specifications

Body Material: Purad® PVDF

Diaphragm: PTFE

Seals: non-wetted FKM

Valve Outlet: 1/4", 3/8" and 1/2" in flare or female NPT

Valve Body Inline: 20-250mm (1/2" – 10") PVDF pipe in SDR21 and 33

Valve Inlet 2-Way: 1/4", 3/8" and 1/2" in spigot or male NPT

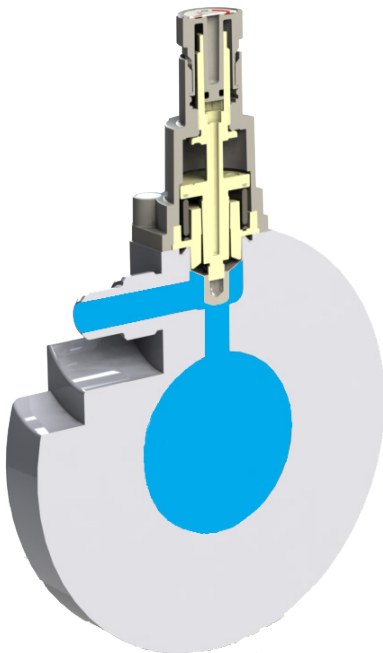

MPV Sampling Valve Cross Section

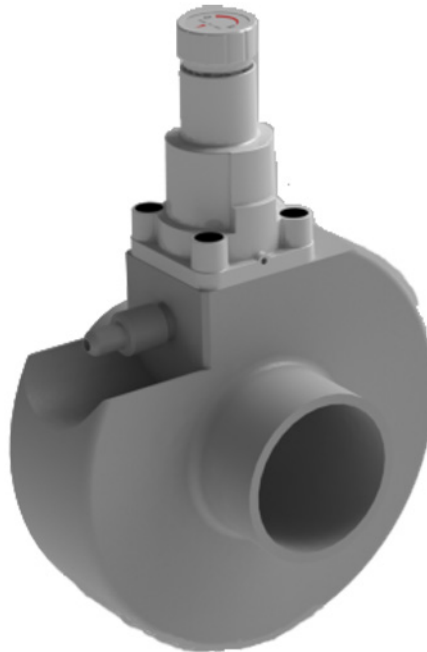

MPV Inline Sampling Valve



MPV 2-Way Sampling Valve



Frank Series Regulators



- Accurate and stable control of pressure, regardless of upstream pressure or downstream demand
- Mechanical parts are isolated from the process fluid
- Adjustable under working pressure

Specifications

Body Material: Purad® PVDF, PolyPure® PP-R and PP-Pure® pigmented

Diaphragm: PTFE or EPDM

Seals: EPDM or FKM (PTFE diaphragm uses FKM)

Maximum Pressure: 150psi at 68°F

Valve Size: 20-110mm (1/2" - 4"), may vary by model

T-241 and V182 Pressure Regulator

The T-241 and V182 pressure regulator is a great value with its integrated gauge guard. This pressure regulator reduces pressure and dampens pulsations from pumps and upstream branch line cycling. The compression spring balances outlet pressure by opening and closing the valve as the inlet pressure changes. The T-241 is the latest PVDF body with upgraded internal wetted parts for improved purity and reduced particle generation.

Size range: 20-110mm (1/2" – 4")



T-241

V185/85 Pressure Relief Valve

The V185 features branch pressure relief to relieve excess pressures to a secondary line. This protects downstream items from dangerous peaks while allowing mainline flow to continue. The piston spring keeps the outlet closed until the set point pressure is achieved.

Size range: PVDF 20-75mm (1/2" – 2-1/2"), PP 20 - 110mm (1/2" – 4")



V185/85

V186/86 Back Pressure Regulator

The V186 back pressure regulator maintains adequate upstream pressure as pressure reduces from branch line cycling. The V186 may also be used as an inline pressure relief valve. The piston spring keeps the outlet closed until the set point pressure is achieved.

Size range: PVDF 20-75mm (1/2" – 2-1/2"), PP 20 - 110mm (1/2" – 4")



V186/86

SP Series Welding Machines

Available for Purchase or Rent

SP equipment precisely controls all movements and parameters of the heating element and pipe clamps during each phase of the welding process. This full automation eliminates operator influence during the fusion process and provides unequalled repeatability.



SP 110-S

IR Fusion

- 20 - 110mm (1/2" - 4")
- Materials:** PE, PP, PVDF, PFA

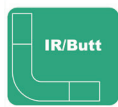

SP 110-S V3

IR Fusion

- 20 - 110mm (1/2" - 4")
- Materials:** PE, PP, PVDF, PFA, ECTFE, Poly-Flo

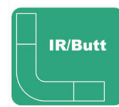

SP 63-S Mobile

IR Fusion

- 20 - 63mm (1/2" - 2")
- Materials:** PE, PP, PVDF, ECTFE



SP 250-S

IR Fusion

- 110 - 250mm (4" - 10")
- Materials:** PE, PP, PVDF



SP 250-S V3

IR Fusion

- 110 - 250mm (4" - 10")
- Materials:** PE, PP, PVDF



SP 315-S

IR Fusion

- 110 - 315mm (4" - 12")
- Materials:** PE, PP, PVDF



SP 110-B

Beadless Fusion

- 20-110mm (1/2" - 4")
- Materials:** PE, PP, PVDF



EF 110-B

Beadless Electrofusion

- 20-63mm (1/2" - 2")
- Materials:** PVDF



Benefits of Force Controlled Welding Technology

Superior Control Over Parameters

The automated force control technology in the SP series of fusion equipment removes the unreliability found in manually operated tools. The equipment automatically controls the movement of the clamps and heating element. The joining pressure is precisely monitored and controlled. Temperature, time and pressure parameters are pre-programmed for each material and size. All parameters are monitored, adjusted and recorded for QA/QC control.

The force control technology weld process prevents excessive joining force found in distance controlled equipment. Plastics inherently shrink when cooled, causing a decrease in the joining force on the welded area. The SP tool maintains force on the joint to produce a strong and consistent weld. The leading technology found in Asahi/America's SP equipment provides unmatched repeatability and reliability.

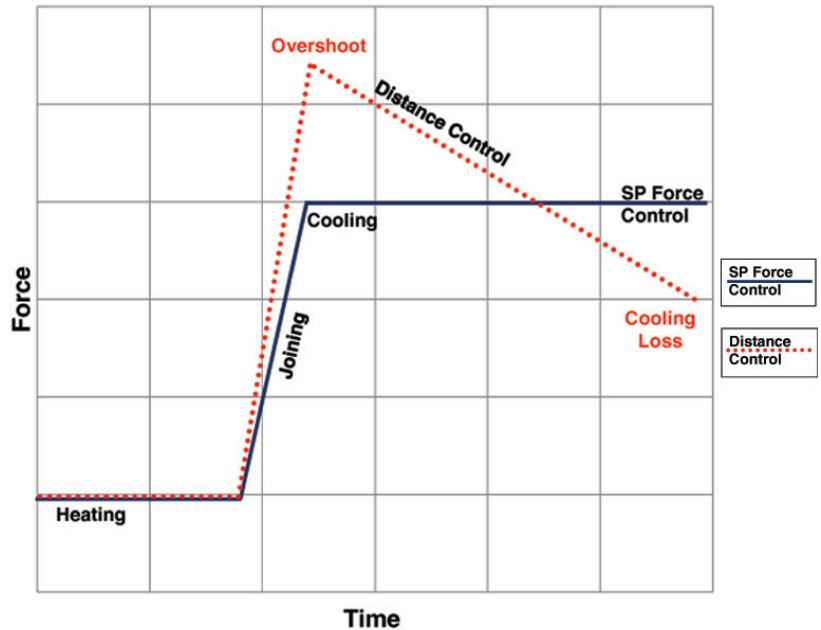

Prevents Cold Welds

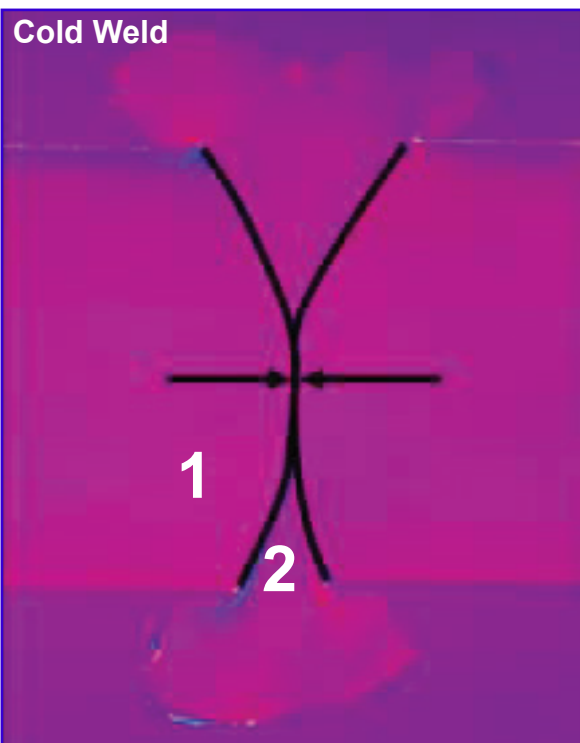

- 1) Pipe wall cross section
- 2) Molten material

Theory

Material is melted into a molten state, then sets as one solid piece. It is the molten material from both components that is fused together to provide the strength and integrity of the joint.

Definition

A cold weld is the result of too much joining force, which displaces the center the molten material. As a result, limited fusion between the material has taken place and the two pieces are contacting each other without a complete bond.



Cold welds do not have the structural integrity required for a piping system.



Cold welds are extremely difficult to visually identify and are usually not discovered until the system is subjected to hydrostatic pressure.

Cold welds are prevented by the SP force controlled welding technology which, automatically controls the joining pressure.



SP 110-S V3 - Automated IR Welding

The V3 model brings the latest innovations and an updated body design to the proven and cutting edge SP 110-S series of IR tools. The V3 incorporates all the great features you have come to rely on in our SP series equipment.



New V3 Features

- Increased automation and speed
- Integrated tool work box
- New planer position provides greater weld area access
- Latest electronic hardware and bigger touch screen
- Increased weld data storage to 20,000
- Smartphone app for weld data
- Additional data on weld labels
- Poly-Flo® double wall weld parameters

Standard SP Features

- Automated force control welding
- Magnetic clamp inserts for fast change out
- Adjustable planing feature
- Adjustable alignment controls
- PFA welding capability - 1/2", 3/4", 1", 1-1/2", 2"

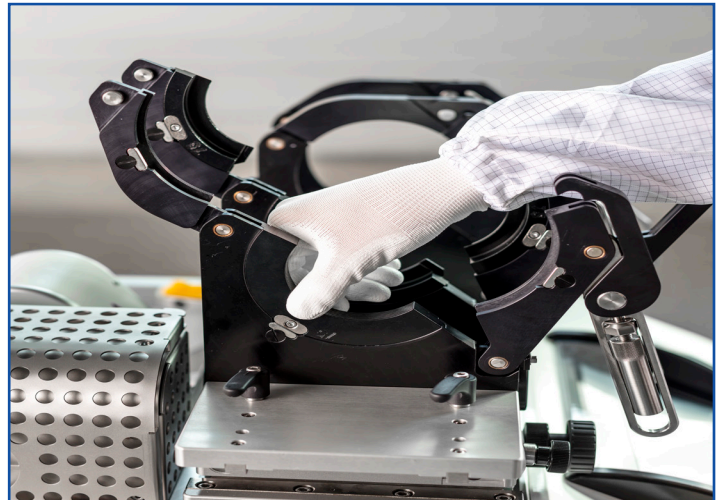

SP 63 Mobile - Force Controlled Welding Technology



The SP 63 mobile IR fusion tool is a great solution for installations requiring repairs or welds to be made in the ceiling. This tool was designed to be compact and allow the key components to break apart for mobility.

The welding equipment is mounted to the included aluminum base for standard shop style welding. This flexibility makes the SP 63 a great option for smaller installation projects at such as universities, healthcare and research facilities.

The SP 63 features our core technology of Force Controlled IR welding. The SP pipe clamps and motor system control the joining force to provide the most repeatable and reliable welds on the market. The SP 63 requires a little more operator involvement than it's fully automated big brother the 110 model. It features a simpler control screen and the operator carries the heating element into the clamps.

This tool includes all the great user features you have come to know in SP tools such as magnetic clamp inserts, adjustable planning, pre-heat parameters and our weld log system.

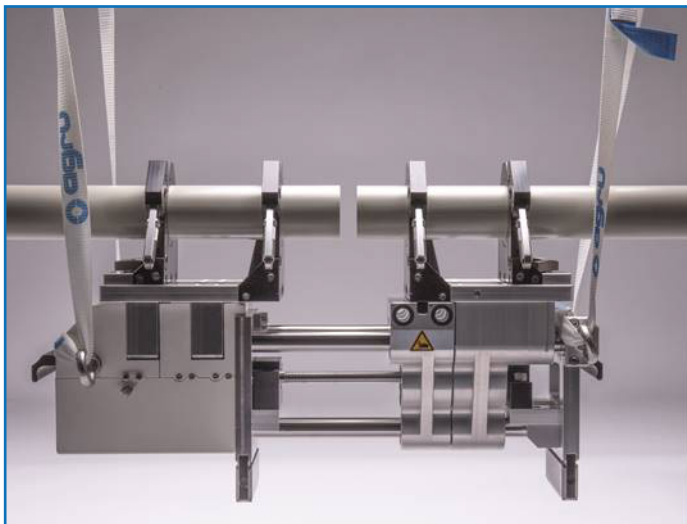

When performing a ceiling weld the clamps should be properly supported to rigid structures to the included eye hole bolts and straps. It can be helpful for a second operator to assist with securing the clamps and the weld process. The SP 63 is easily capable of doing both horizontal and vertical welds.

SP-S Welding Best Practices

Set Pipe	Cleaning	Planing	Alignment	Cap Ends	Welding	QC
•Set After Clamps Fully Close	•IPA Clean Prior to Planing	•Push Planar Out to Fully View Ends	•Adjust Left Vertical Cam First	•Cap All Elbows, Tees and Branches	•Watch Melt Flow and Joining	•Examine Before Accepting

SP 110-S Adjustable Planing

CAUTION: Actual “Weld Loss” will vary based on material, pipe size and temperature differences. These are approximate typical values for fabrication reference only. “Total Loss” means from both planing and welding. “Tool Setting” is the adjustable planing amount with a default of 3.0mm.

This chart is based on the SP 110-S, the SP 250/315-S loss may be 1/16”-1/8” bigger.

Tool Setting (mm)	3.0	3.5	4.0	4.5	5.0	5.5	6.0	6.5	7.0	7.5	8.0
Total Loss (in)	3/16	3/16	1/4	1/4	1/4	1/4	5/16	5/16	5/16	3/8	3/8

Tool Setting (mm)	8.5	9.0	9.5	10.0	10.5	11.0	11.5	12.0	12.5	13.0
Total Loss (in)	3/8	7/16	7/16	1/2	1/2	1/2	1/12	9/16	9/16	9/16

IR Weld QC Criteria

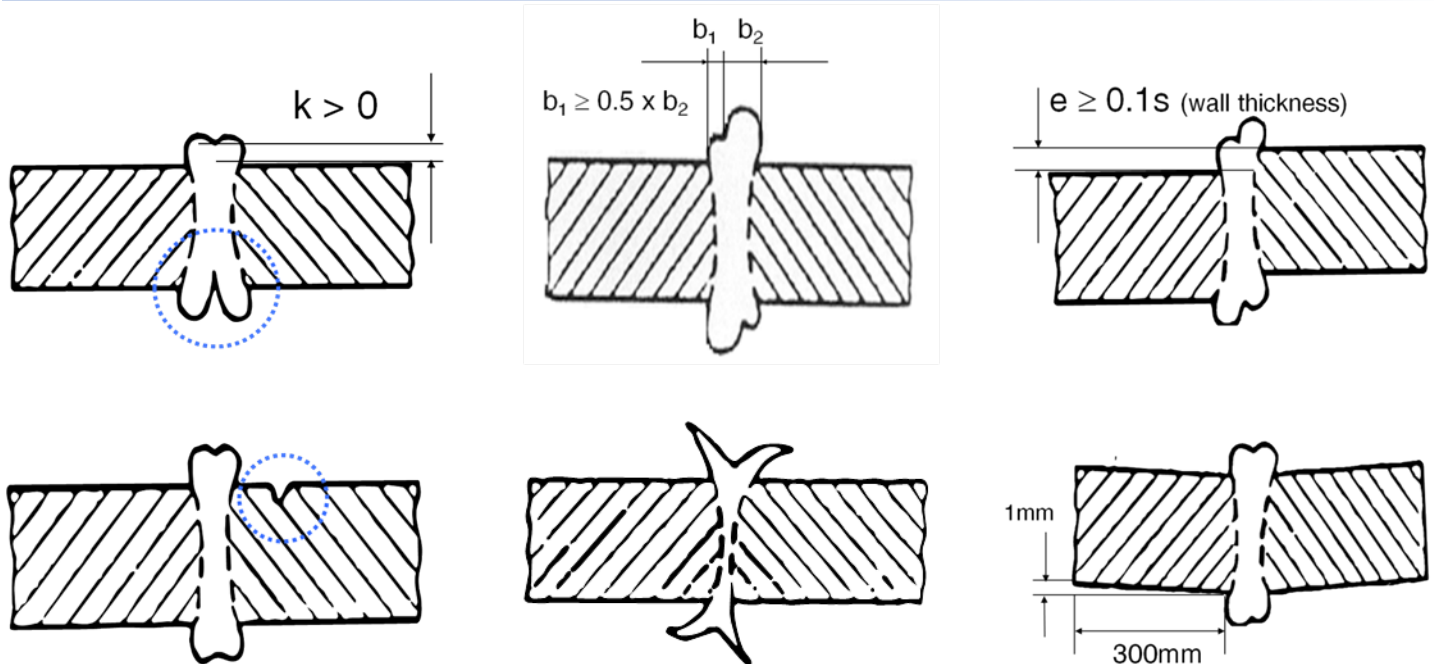

SP-S Welding Best Practices

IR Weld QC Criteria: Bead Size

CAUTION: Bead size may vary based on ambient temperature, heat convection, gravity and component type (fitting vs. pipe). The different SP-S tool models (110/250/315) may also produce slightly different bead sizes for similar pipe sizes.

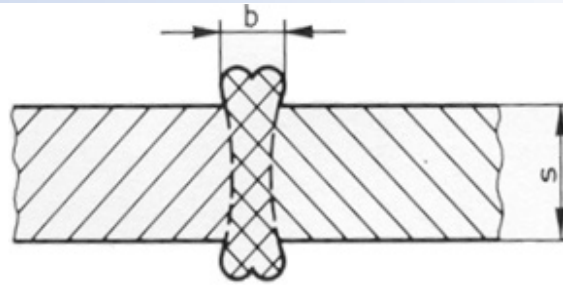

PVDF Pipe Size	Min Weld Bead (b)	Max Weld Bead (b)
20 x 1,9 SDR21	0.059"	0.126"
25 x 1,9 SDR21	0.059"	0.126"
32 x 2,4 SDR21	0.063"	0.134"
40 x 2,4 SDR21	0.063"	0.134"
50 x 3,0 SDR21	0.067"	0.146"
63 x 3,0 SDR21	0.067"	0.146"
75 x 3,6 SDR21	0.071"	0.157"
90 x 4,3 SDR21	0.079"	0.169"
110 x 5,3 SDR21	0.083"	0.189"
125 x 6,0 SDR21	0.091"	0.205"
140 x 6,7 SDR21	0.094"	0.217"
160 x 7,7 SDR21	0.102"	0.236"
180 x 8,6 SDR21	0.110"	0.256"
200 x 9,6 SDR21	0.118"	0.276"
225 x 10,8 SDR21	0.126"	0.295"
250 x 11,9 SDR21	0.138"	0.319"
280 x 13,4 SDR21	0.146"	0.346"

Polypropylene Pipe Size	Min Weld Bead (b)	Max Weld Bead (b)
20 x 1,9 SDR11	0.070"	0.197"
25 x 2,3 SDR11	0.079"	0.201"
32 x 2,9 SDR11	0.083"	0.209"
40 x 3,7 SDR11	0.087"	0.220"
50 x 4,6 SDR11	0.091"	0.236"
63 x 5,8 SDR11	0.094"	0.248"
75 x 6,8 SDR11	0.098"	0.264"
90 x 8,2 SDR11	0.102"	0.280"
110 x 10,0 SDR11	0.110"	0.307"
125 x 11,4 SDR11	0.114"	0.327"
140 x 12,7 SDR11	0.122"	0.346"
160 x 14,6 SDR11	0.126"	0.374"
180 x 16,4 SDR11	0.138"	0.398"
200 x 18,2 SDR11	0.142"	0.421"
225 x 20,5 SDR11	0.150"	0.449"
250 x 22,7 SDR11	0.161"	0.484"
280 x 25,4 SDR11	0.169"	0.516"

High Purity Design and Installation

Overview

The following information is intended to provide an overview for designing a high purity piping system. Please consult our Engineering Design Guide for complete technical information.

Material and Piping System Selection

There are several factors to consider when choosing the appropriate material for the piping system. The first step is to define your water quality.

What are the water quality specifications?

Stringent water quality specifications would indicate a need to choose Purad® UHP PVDF piping system as this will provide the lowest level of leachouts. Less stringent requirements allow consideration to utilize the cost savings offered by PolyPure® or PP-Pure®.

What are the end products and how will water quality impact them?

Will this water system be utilized in the manufacturing of high-value products such as micro-electronics or pharmaceuticals? If manufacturing down-time and product yield are critical and costly, then Purad® UHP PVDF is the best choice.

What is the system's capital budget?

PVDF piping systems are five to 10 times the cost of a comparative PP system. While PVDF offers unparalleled purity, when budget concerns are the primary consideration, PolyPure® and PP-Pure® offer less stringent purity performance at reduced prices.

What is the system size range?

PolyPure® natural PP is only commercially offered up to 110mm (4"). For customers who are interested in the cost savings of PP but have large diameter line sizes, PP-Pure® is an excellent choice.

Why should I choose Asahi/America?

When comparing competitive systems it is important to recognize the higher quality of Asahi/America's piping systems. Many competitors do not utilize high purity raw materials or follow stringent high purity manufacturing practices to the same level as Asahi/America. In addition, inferior fusion and joining methods are used, which may jeopardize system purity and integrity.



Design Considerations

Proper system design is critical for well functioning high purity piping systems. The system layout, material selection and component specifications can have significant impacts on initial cost of ownership, system startup time, system operation, water quality and operating costs.

Diaphragm Valves

T-342 diaphragm valves are the ideal choice for valves in a high purity water system as the valve design eliminates entrapment areas for bacteria to grow.

For branches and laterals, our T-343 zero dead leg diaphragm valves (ZDLs) eliminate dead space where bacteria can grow.

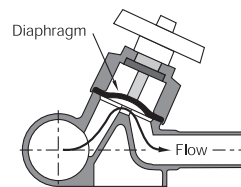

Sampling Valves

Asahi/America offers three types of sampling valves. Our Dymatrix™ MPV sampling valve features a poppet PTFE diaphragm for the highest level of purity. Our EM-Technik needle valve is a popular and cost-effective choice. Additional details can be found on page 9.



Instrument Fittings

Instrument fittings also reduce dead space and are the best way to attach gauges, sampling valves and instruments to the system. The large center shoulder provides an area to place a threaded tap or welded connection.

Gauge Guards

This true union gauge isolator has no wetted elastomers and uses a double-pipe design to completely eliminate the dead volume associated with traditional gauge isolators. Its flow through design matches the internal diameter of your piping system providing, essentially, zero pressure drop.

High Purity Design and Installation



Asahi/America can custom make instrument fittings to any specification. Our exclusive IR lateral fusion process allows us to weld to the branch of the instrument fittings with a clean and reliable IR weld.

UV Lights

UV lights are commonly used to kill bacteria in high purity water systems. Light traps are a fitting assembly with two elbows in an “S” shape, which block the UV light from travelling into the system. Light traps should be used to prevent damage to plastic piping components, as not all plastics are resistant to UV. PVDF is resistant to wavelengths above 250 nm, but high energy 185 nm will attack PVDF. Polypropylene (PP) is not resistant to UV light at all. Light traps constructed of PVDF (for wavelengths above 250 nm only) or stainless steel should always be used.

Pressure and Flow Regulation

Proper system pressure regulation and flow rate are required to make sure all points of use receive adequate flow supply. In addition, flow rate is important to high purity water systems as it can effect the growth and spread of bacteria in a system.



Hot Systems and Thermal Expansion

Some high purity water systems are designed to be run at high temperatures (60 - 80°C) in order to control bacteria growth. PVDF is suitable for these elevated temperatures and our Purad® UHP piping system is an excellent choice for your hot UPW system. Proper design of thermal expansion loops with restraint fittings should be implemented. Technical details can be found in our Engineering Design Guide and we offer an Excel based calculator.

Welding Methods

There are a wide variety of welding methods available for high purity plastic piping systems. Choosing the right welding method can have a significant impact on your water quality. Asahi/America offers the latest technology of welding equipment in all these methods and supports them with operator training, field service and factory service.

IR Fusion

Asahi/America strongly recommends the use of IR fusion for all high purity water systems whenever possible due to its cleanliness, reliability and ease of installation.

IR fusion is a form of butt fusion where the piping components do not contact the heating plate. This eliminates contamination from the heating element into the weld zone, which occurs in contact butt and socket fusion. The interior welds on IR fusion are significantly smaller than contact butt and socket fusion, which reduces the chances for bacteria growth.

Asahi/America’s cutting edge SP series of IR fusion equipment is fully automated and provides force control welding technology. When utilizing IR fusion with our equipment, you receive unmatched reliability and repeatability of the weld process. This reduces operator error, prevents cold welds and makes QC/QA inspection easier.

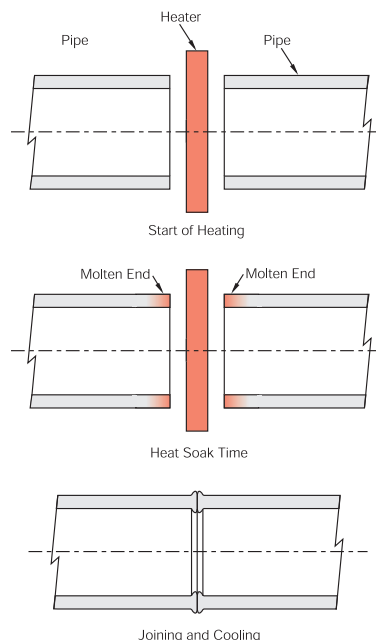

High Purity Design and Installation

Beadless Fusion

Beadless fusion utilizes a clamp over heating element on the exterior of the pipe and a balloon on the interior to eliminate the interior weld bead. Beadless fusion is utilized for critical high purity water systems where interior weld beads are avoided for stringent bacteria concerns. Common applications include high end pharmaceutical water systems.



SP 110-B Beadless Welding Tool

Beadless fusion should only be selected when necessary for the water system, as it will significantly impact installation and fabrication costs. Beadless fusion has much longer weld times than IR fusion. The special weld heads on beadless fusion prevent tight weld dimensions of fittings during fabrication.

HPF Electrofusion

HPF electrofusion utilizes an electrofusion coupling over the piping components to weld the material. The coupling is connected by electrical cables to the welding machine. Copper coils are molded into the middle of the fitting and as electrical current flows through them, the material is heated and fused. An optional balloon may be inserted to reduce the weld bead and crevices. This is a unique system offered by Asahi/America for PVDF only.



EF 110-B

HPF is an excellent means of tying in, repairing or working in tight quarters of your PVDF system. The connection cables are 16 feet long and allow for easy access to tough welding spaces. Asahi/America and others do offer field repair models of IR tools and remote weld heads. Many satisfied customers utilize HPF fusion for their intricate welding needs.

Butt and Socket Fusion

In traditional (contact) butt fusion, the material is in contact with the heating plate. The weld bead in butt fusion is larger than that of IR fusion. The weld bead in socket fusion is the largest of any of these methods, and the heater socket bushings contact the most surface area.

Asahi/America strongly recommends the use of IR fusion for all high purity water systems whenever possible due to its cleanliness and reliability. In some cases, it may be advantageous to allow the use of contact butt or socket fusion.

Small polypropylene piping systems can be very cost effective. The higher cost of IR fusion equipment can sometimes outweigh the cost of the piping material. Many mechanical contractors already own contact butt fusion or socket fusion equipment. In addition, socket fusion welds can be fabricated more quickly than IR or butt fusion, which may save on installation costs.

IR fusion equipment is most easily done on a bench top. If the system installation requires numerous field tie-ins or plenum welds, butt and socket fusion may be advantageous.

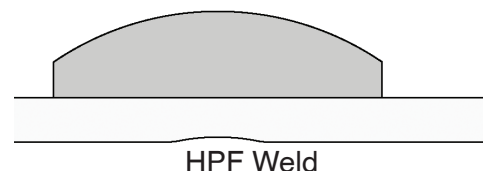
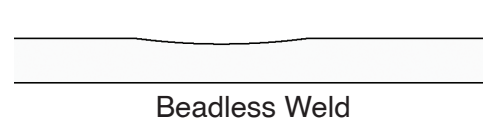
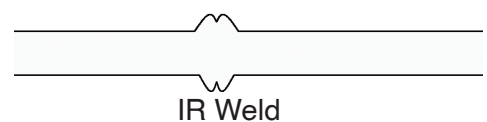
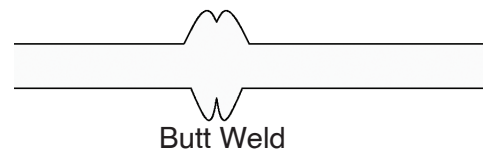
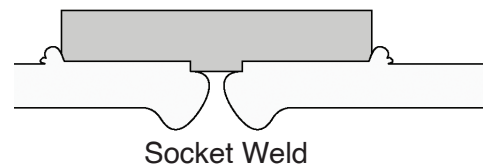

Specialty Products and Custom Fabrication



Custom Fabrication

Asahi/America's team of craftsmen in our Lawrence, MA and Gramercy, LA facilities are positioned to create custom pipe spools, fittings and accessories in a wide range of corrosion resistant thermoplastic materials.

Supported by our application engineers and CAD design professionals our experienced staff is able to create custom pieces to meet your applications requirements.

From concept to completion, from one to many we can meet your needs. We can create simple custom fittings to prefabrication of spool pieces, our services will streamline your installation. Asahi private labels custom skids, complex machined parts and high volume assemblies for our OEM customers.

Another Corrosion Problem Solved.™



ASAHI/AMERICA®
Your Experts in Plastics™

Tel: 800-343-3618; 781-321-5409

Direct Sales: East (800) 232-7244
Central (800) 442-7244
West (800) 282-7244

Fax: 800-787-6861

www.asahi-america.com
asahi@asahi-america.com

The
Wet
Process
People™